

**Adusumilli Gopalakrishnaiah & Sugarcane Growers
Siddhartha Degree College of Arts & Science**

Vuyyuru – 521165, Krishna District, Andhra Pradesh

(An Autonomous College in the Jurisdiction of Krishna University, Machilipatnam)

Accredited by NAAC with "A" Grade

ISO 9001:2015 Certified Institution

2022-2023

ODD SEMESTER



DEPARTMENT OF ZOOLOGY





MINUTES OF BOARD OF STUDIES

B.Sc. AQUACULTURE

22-10-2022

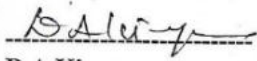
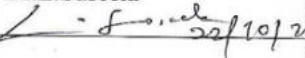
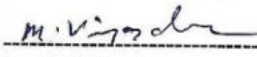

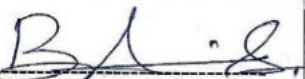
Minutes of the meeting of Board of studies in Zoology for the Autonomous courses of AG & SG Siddhartha Degree College of Arts & Science, Vuyyuru, held at 3:00 pm on 22-10-2022 in the Department of Zoology.

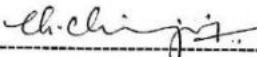
S.No	Name	Designation	signature
1.	Smt. D.A.Kiranmayee Head, Department of Zoology A.G&S.G.S Degree College Vuyyuru	Chair person	 D.A.Kiranmayee
2	Smt. Dr.L.Suseela Bio Sciences & Bio technology Krishna University Machilipatnam.	University Nominee	Dr.L.Suseela  22/10/22
3.	Sri Dr.M.Vijay kumar Head, Department of Zoology SRR & CVR Govt. Degree College, Vijayawada.	Subject Expert	 Dr.M.Vijay kumar
4.	Sri Ch. Venkateswaralu, Head, Department of Zoology, P.B. Siddhartha College, Vijayawada.	Subject Expert	 Ch. Venkateswaralu,
5.	Sri.B. Appala Naidu, Asst. Project Manager, RGCA Manikonda.	Industrialist	 B. Appala Naidu,
6.	Smt. K. Padmaja, Lecturer in Zoology, A.G&S.G.S Degree College Vuyyuru-	Member	 K. Padmaja,
7	Smt. Dr.V.Subhashini, Lecturer in Zoology, A.G & S.G.S Degree College Vuyyuru-	Member	 Dr.V.Subhashini
8	Sri.Ch.Chiranjeevi, P.hd –Research Scholar, Dept.of Botany & Microbiology, Acharya Nagarjuna University Guntur.	Student Represent	 Ch.Chiranjeevi,

AQUACULTURE

Agenda for B.O.S Meeting.

1. To recommend the syllabi (Theory & Practical), Model question paper for I Semester of I B.Sc (A.B.C) for the academic year 2022-2023.
2. To recommend the syllabi (Theory & Practical), Model question paper for III Semester of II B.Sc (A.B.C) for the academic year 2022-2023.
3. To recommend Semester End Internship (Apprenticeship) to students of III ABC for the academic year 2022-2023 in V Semester
4. To recommend the syllabi (Theory & Practical), Model question paper and Blue print of I, III & V semester of I, II, III B.Sc (A.B.C.) for the academic year 2021-2022.
5. To recommend the teaching and evaluation methods to be followed under Autonomous status.
6. Any other matter.



Chairman.

RESOLUTIONS

1. It is resolved to continue the same syllabi (Theory & Practical), model question paper of I Semester of I B.Sc. (A.B.C) under Choice Based Credit System (CBCS) for the academic Year 2022 – 2023.
2. It is resolved to continue the change syllabi (Theory & Practical), model question paper of III Semester of II B.Sc. (A.B.C) under Choice Based Credit System (CBCS) for the academic Year 2022 – 2023.
3. It is resolved to send students of III ABC for Semester End Internship (Apprenticeship) for the academic year 2022-2023 in V Semester
4. It is resolved to follow the Model question paper and Blue print of I,III& V semester of I,II & III B.Sc (A.B.C.) for the academic year 2022-2023.
5. It is resolved to continue the following teaching & evaluation methods for the Academic year 2022-23.
6. Any other matter.

Teaching methods:

Besides the conventional methods of teaching, we use modern technology i.e. Using of OHP and LCD projector to display on U boards etc; for better understanding of concepts.

Evaluation of a student is done by the following procedure:

❖ Internal Assessment Examination:

- ❖ Out of maximum 100 marks in each paper for I & III B.Sc(A.B.C) 30 marks shall be allocated for internal assessment.
- ❖ Out of these 30 marks, 20 marks are allocated for announced tests (i.e . IA-1& IA-2). Two announced tests will be conducted and average of these two tests shall be deemed as the marks obtained by the student, 5 marks are allocated on the basis of candidate's percentage of attendance and remaining 5 marks are allocated for the assignment for I& III B.Sc (A.B.C).
- ❖ Out of maximum 100 marks in each paper for II B.Sc(A.B.C) 25 marks shall be allocated for internal assessment.
- ❖ Out of these 25 marks, 15 marks are allocated for announced tests (i.e . IA-1& IA-2). Two announced tests will be conducted and average of these two tests shall be deemed as the marks obtained by the student, 5 marks are allocated on assignment and remaining 5 marks seminars for III semester.
- ❖ There is no pass minimum for internal assessment for I, II, III B.Sc

❖ Semester – End Examination:

- ❖ The maximum mark for I (ABC) semester – End examination shall be 75 marks and duration of the examination shall be 3 hours.
- ❖ The maximum mark for III, V (A.B.C) semester – End examination shall be 70 marks and duration of the examination shall be 3 hours. Even though the candidate is absent for two IA exams/ obtain Zero marks the external marks are considered (if the candidate gets 40/70) and the result shall be declared as “PASS”.
- ❖ Semester – End examination shall be conducted in theory papers at the end of every semester, while in practical papers, these examinations are conducted at the end of I, III & V semester for I, II & III B.Sc, (A.B.C).

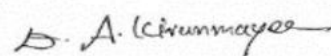

Chairman

**ADUSUMILLI GOPALAKRISHNAIAH & SUGAR CANE GROWERS SIDDHARTHA DEGREE
COLLEGE OF ARTS & SCIENCE, VUYURU-521165, KRISHNA Dt., A.P. (AUTONOMOUS).**

NAAC reaccruited at 'A' level
Autonomous –ISO 9001-2015 Certified

Title of the Paper: **Basic Principles of Aquaculture**

Semester: - I

Course Code	<i>AQTTIA</i>	Course Delivery Method	Class Room/Blended Mode - Both
Credits	3	CIA Marks	30
No. of Lecture Hours/ Week	4	Semester End Exam Marks	70
Total Number of Lecture Hours	60	Total Marks	100
Year of Introduction : 2019-2020	Year of Offering 2019-2020	Year of Revision – 2021-22	Percentage of Revision: 50%

OBJECTIVES

- To study the concept of blue revolution and its impact at global, national and state level.
- To get acquainted with different culture systems and culture methods.
- To study the different types of ponds used in culture practices.
- To study the criteria for construction of ideal fish pond.
- To study the management practices in fish/ prawn culture.

PREREQUISITE

- Knowledge of fisheries management acquired in Intermediate.

COURSE OUTCOMES

By the end of the course students will be able to

CO 1	Understand the concept of blue revolution, analyse the history and compare the present status of aquaculture at global, national and state levels and its significance over agriculture and gain knowledge in the various aquaculture resources and advantages of culture over capture.
CO 2	Acquire knowledge in the different types of aquaculture, culture systems and culture methods in practice worldwide.
CO 3	Gain knowledge in the different types of culture ponds.
CO 4	Understand the arrangement of different types of ponds in a fish farm and design an ideal fish farm.
CO 5	Comprehend the best management practices to be adopted in aquaculture for good yield and acquire the skill in the analysis of water and soil parameters of a culture pond.
CO 6	Identify the different types of weeds and predators in a culture pond and suggest the suitable control measures for their eradication.

Syllabus
Course Details

Unit	Learning Units	Lecture Hours
I	<p>UNIT-I (Introduction) Definition and History of Aquaculture Concept of Blue Revolution and PradhanMantriMatsyaSampadaYojana (PMMSY) Present status of Aquaculture at global level, India and Andhra Pradesh Aquaculture versus Agriculture; Present day needs with special reference to Andhra Pradesh Aquaculture resources: Ponds, tanks, lakes, reservoirs etc. Capture and Culture fisheries; Advantages of culture fishery over capture fishery</p>	11
II	<p>UNIT-II (Types of Fish Ponds) Lotic and lentic systems, streams and springs Functional classification of ponds – head pond, hatchery, nursery, rearing, production and stocking ponds; quarantine ponds, isolation ponds and wintering ponds Hatchery design</p>	11
III	<p>UNIT- III (Design and Construction of Aqua Farms) Important factors in the construction of an ideal fish pond – site selection, topography, nature of the soil, water resources Lay out and arrangement of ponds in a fish farm Construction of an ideal fish pond – space allocation, structure and components of barrage Pond</p>	10
IV	<p>UNIT-IV (Aquaculture Systems and Practices) Types of aquaculture Aquaculture Systems – Pond, Raceways, Cage, Pen, Rafts, Running water, Water Recirculating Systems, Biofloc Technology and 3-C System Pond cu Fin fish culture methods - Monoculture, Polyculture and Monosex culture and Integrated fish farming.</p>	12
V	<p>UNIT-V (Management Factors of Culture Ponds) Pre-stocking Management Dewatering, drying, ploughing/desilting Liming and fertilization; Need of fertilizer and manure application, NPK contents of different fertilizers and manures and precautions in their Application Predators, weeds and weed fish in culture ponds - Advantages and disadvantages of weed plants; Toxins used for weed control and control of predators. Algal blooms and their control Stocking Management – Stocking density and stocking Post-stocking Management Feeding: Role of nutrients Water quality: Physico-chemical conditions of soil and water optimum for</p>	14

	<p>culture – temperature, depth, turbidity, light, water and shore currents, PH, DOD, CO₂, NH₃, NO₂ and nutrients</p> <p>Measures to increase oxygen and reduce ammonia & hydrogen sulphide in culture ponds; correction of PH</p>	
--	---	--

PRESCRIBED BOOK(S):

Jhingran VG 1998. Fish and Fisheries of India. Hindusthan Publishing Corporation, New Delhi
 Pillay TVR, 1996. Aquaculture Principles and Practices, Fishing News Books Ltd., London

REFERENCES:

Pillay TVR & M.A. Dill, 1979. Advances in Aquaculture. Fishing News Books Ltd., London
 Stickney RR 1979. Principles of Warm Water Aquaculture. John Wiley & Sons Inc. 1981
 Boyd CE 1982. Water Quality Management for Pond Fish Culture. Elsevier Scientific Publishing
 Bose AN et.al, 1991. Coastal Aquaculture Engineering. Oxford & IBH Publishing Company.

CO-CURRICULAR ACTIVITIES

1. Collection of data on present status of aquaculture
2. Animal album-making
 - a. Plankton
 - b. Aquatic weeds
 - c. Aquatic Insects
 - d. Algal Blooms
 - e. Weed and Predatory fish
3. Preparation of clay models of different ponds in a fish farm.
4. Field survey of nearby habitat for dietary dependency on and requirement of aqua- products
 Collection of water and soil samples and estimation of various parameters.
 Preparation of charts on aeration devices.
 Collection of different culture species stage-wise {spawn, fry, fingerlings, zero size and adult (more than 200 g)}

ADUSUMILLI GOPALAKRISHNAIAH & SUGAR CANE GROWERS SIDDHARTHA DEGREE COLLEGE OF ARTS & SCIENCE, VUYYURU-521165, KRISHNA Dt., A.P. (AUTONOMOUS).

I SEMESTER END EXAMINATIONS

MODEL PAPER

Code:AQTT11A

**Title of the paper: Basic Principles of Aquaculture
 (W.E.F 2022-2023)**

Time: 3 Hours

Max.

Marks: 70

Answer **ALL** the following questions 5X14=70m

- 1(a) Define capture and culture fisheries. List out the advantages of culture fishery over capture fishery CO1, L1 10M
- b) Explain the significance of Biofloc Technology CO2, L2 5M
- OR
- c). Mention the present status of Aquaculture at global level, India and Andhra Pradesh CO,1 L1- 10 M
- d) Explain the concept of blue revolution CO1, L2 5M
2. a) Explain the different types of freshwater aquaculture CO2, L2 10M
- b). Lotic and lentic systems CO2 L1 5M
- OR
- c) Describe the different types of pond culture methods. CO2, L2 10M
- d) What is Quarantine ponds CO1, L1 5M
3. a) Give an account of the different types of hatcheries and describe the design of a modern hatchery. CO4 L2 10M
- b). Classify ponds based on water resources. CO4, L2 5M
- OR
- c) Explain the space allocation CO3 L2 10M
- d) Mention the criteria for site selection of an ideal fish pond CO4, L1 5M
4. a). Describe the structure and components of a barrage pond. CO4, L1 10M
- b). What is Mari culture? CO2, L1 5M
- OR
- c). Describe the lay out and arrangement of nursery pond in a fish farm. CO4, L1 10M
- d). Explain the importance of Integrated fish farming. CO4 CL3 5M
5. a) Analyze the physico-chemical conditions of water optimum for fish culture. CO5L4 10 M
- b). Analyze the control measures for weed fish in culture ponds CO6, L4 5M
- OR
- c). Write an essay on aquatic weed plants in a fish pond, their advantages and disadvantages CO6, L4 10M
- d). Justify the role of nutrients in a fish pond. CO5, L 5 5 M

A.G. & S.G.SIDDHARTHA DEGREE COLLEGE OF ARTS & SCIENCE, VUYYURU-521165,
KRISHNA Dt.,A.P. (AUTONOMOUS)

AQUACULTURE
PRACTICAL – I

w.e.f. 2022-2023.

Code: AQTP11A

MAX.MARKS: 40.

(2hrs/week)

LEARNING OUTCOMES:

By the end of the course students will be able to

- Identify the various live food organisms in the culture ponds.
- Identify the aquatic weeds, insects and weed fish causing damage to the cultured animals and suggest measures to control the algal blooms in culture ponds.
- Understand the mechanism of aeration devices used in culture ponds.
- Develop skill in analysing the various water and soil parameters.
- Gain practical knowledge in the management of different types of ponds in a fish farm.
- Understand the importance of preservation of museum specimens and identify the animals based on special identifying characters.
- Maintain a neat, labeled record of identified museum specimens and exhibit the hidden creative talent.

SYLLABUS

1. Estimation of Carbonates, Bicarbonates in water samples
2. Estimation of Chlorides in water samples
3. Estimation of Dissolved Oxygen
4. Estimation of Ammonia in water.
5. Estimation of Total Hardness of water sample.
6. Determination of soil Nitrogen and Phosphorus.
7. Study of beneficial and harmful algal species
8. Study of aeration devices
9. Collection, identification and isolation of zooplankton and phytoplankton
10. Collection and study of aquatic weeds, aquatic insects, weed fish and larvivorous fish
11. Study of fish species banned from culture (*Clarius gariepinus*, *Hypostomus plecostomus*)
12. Field visit to hatchery, nursery, rearing and stocking ponds of aqua farms.

PRESCRIBED BOOK(S):

1. Jhingran VG 1998. Fish and Fisheries of India, Hindustan Publishing Corporation, New Delhi
2. Pillay TVR, 1996. Aquaculture Principles and Practices, Fishing News Books Ltd., London

REFERENCES

1. Boyd CE. 1979. Water Quality in Warm Water Fish Ponds. Auburn University
2. Boyd, CE. 1982. Water Quality Management for Pond Fish Culture. Elsevier Sci. Publ. Co.
3. FAO. 2007. Manual on Freshwater Prawn Farming.

**I B.Sc AQUACULTURE
PRACTICAL EXAMINATION**

Practical - I

AQT P11A

Title of the paper: Basic Principles of Aquaculture

Course Code:

Time: 3hrs.

Max. Marks 40M

I. Estimate the amount of Chlorides/ Dissolved Oxygen/Free Carbon dioxide /Total Hardness of the given sample. CO4, L5

10 M

Procedure: 5M

Calculations: 3M

Report: 2M

II. Identify, draw labelled diagram, classify and comment on

5x3=15 M

CO1, CO2, CO6, L3

- A. Algal Blooms
- B. Plankton
- C. Aquatic weed
- D. Aquatic Insect
- E. Weed Fish

Identification : 1M

Diagram : 1/2 M

Notes : 11/2M

III. Practical Record Book CO7, L3
5M

IV. Field note Book CO5, L1
5M

V. VIVA CO7, L5
5M

**ADUSUMILLI GOPALAKRISHNAIAH & SUGAR CANE GROWERS SIDDHARTHA
DEGREE COLLEGE OF ARTS & SCIENCE, VUYURU-521165, KRISHNA Dt., A.P.
(AUTONOMOUS).**

NAAC reaccredited at 'A' level
Autonomous –ISO 9001-2015 Certified

Title of the Paper: **Fresh water & Brackish water Aquaculture**

Semester: - III

Course Code	AQTT31A	Course Delivery Method	Class Room/Blended Mode - Both
Credits	3	CIA Marks	25
No. of Lecture Hours/ Week	4	Semester End Exam Marks	75
Total Number of Lecture Hours	60	Total Marks	100
Year of Introduction :	Year of Offering	Year of Revision –	Percentage of Revision:

Objective of the course: The students understand Fresh water & Brackish water Aquaculture.

Course outcomes:

CO1: Learn the Status, Scope and Prospects of fresh water aquaculture in the world, India and AP.

CO2: Learn about Major Cultivable Indian Carps and Exotic fish Species introduced in India

CO3: Know about recent developments in the culture of clarius, anabas and murrels and special systems of aquaculture.

CO4: Gain knowledge of commercially valuable Fresh water prawns of India and their culturing methods. CO5: Learn about culturing of brackish water Prawn Species P.mondon and L.vannamei and hatchery technology's involved

Learning Objectives:

- To know the present status of freshwater and brackish water aquaculture and their role in world economy and food production.
- To gain knowledge on carp, prawn, shrimp and crab culture and composite fish culture systems.
- To improve the technical knowledge on fish and shrimp hatchery technology and culture practices.
- To improve the knowledge and technical skills for the identification of cultivable fin fish and shell fish.

Syllabus

Course Details

Unit	Learning Units	Lecture Hours
I	<p>Freshwater Fin Fish Aquaculture</p> <p>Status, scope and prospects of freshwater aquaculture in the world, India and AP</p> <p>Criteria for the selection of species for culture</p> <p>Natural seed resources and procurement of seed for stocking</p> <p>Culture of cultivable major Indian carps – <i>Labeo</i>, <i>Catla</i> and <i>Cirrhinus</i> and Minor carps</p> <p>Culture of Exotic fish species – <i>Tilapia</i>, <i>Pangassius</i> and <i>Clarius species</i></p> <p>Impact of exotic fish, compatibility of Indian and exotic carps and Competition among them</p> <p>Composite fish culture system of Indian and exotic and genetically modified carps (Amur common carp, Jayanthi Rohu)</p>	13
II	<p>Freshwater Shell Fish Aquaculture</p> <p>Freshwater prawns of India -commercial value</p> <p>Natural seed resources and procurement of seed for stocking</p> <p><i>Macrobrachium rosenbergii</i> – biology, seed production, pond preparation, stocking,</p> <p>Management of nursery and grow-out ponds, feeding, morphotypes and harvesting</p> <p><i>M. malcolmsonii</i> - biology, seed production, pond preparation, stocking,</p> <p>Management of nursery and grow-out ponds, feeding, morphotypes and harvesting</p>	14
III	<p>Brackish Water Fin Fish Aquaculture</p> <p>Status, scope and prospects of brackish water aquaculture in the world, India and AP</p> <p>Major cultivable species for brackish water aquaculture</p> <p>Biology and culture of <i>Latescalcarifer</i></p> <p>Biology and culture of <i>Chanoschanos</i></p> <p>Biology and culture of <i>Mugilcephalus</i></p> <p>Biology and culture of <i>Etroplus suratensis</i></p> <p>Biology and culture of <i>Trachinotus</i> spp (Pampano)</p>	15
IV	<p>Brackish Water Shell Fish Aquaculture-I</p> <p>Culture of <i>P. mondon</i> – Hatchery technology and culture practices including feed and Disease management</p> <p>Culture of <i>L. vannamei</i> – Hatchery technology and culture practices including feed and Disease management.</p> <p>Mixed culture of fish and prawns</p>	11
V	<p>Export – oriented Brackish Water Shell Fish Aquaculture-II</p> <p>Biology and culture of <i>Scylla serrata</i></p> <p>Biology and culture of <i>Pinctada vulgaris</i></p> <p>Biology and culture of <i>Crassostrea</i> species</p>	07

A.G. & S.G.Siddhartha Degree College of Arts & Science, Vuyyuru – 521165,
Krishna Dt. A.P. (Autonomous)

Semester –III

Time: 3hrs

Model question paper

w.e.f. 2022-2023

Title of the paper: Fresh water & Brackish water Aquaculture.

Code –

AQTT31A

max.marks: 75

SECTION – A

Answer and FIVE of the following

5x5=25

Marks

1. Discuss the status of freshwater aquaculture in Andhra Pradesh. CO2, L2
2. Analyse the advantages of composite fish culture of carps CO1, L2.
3. Explain the natural seed resources of freshwater prawns CO3, L1
4. Analyze the significance of morpho types in scampi CO3, L4
5. Explain the culture aspects of sea bass in Andhra Pradesh CO4, L2
6. Explain the impact of disease management on the harvest in *L.vennamei* CO5, L4
7. Describe the off-bottom culture methods of edible oysters CO6, L1
8. Describe the biology of silver pompano CO4, L3

SECTION – B

Answer the following questions.

5X10=50

Marks

9. Enumerate the various criteria for the selection of species for culture. CO1 L1
OR
Explain the culture of Indian major carps. CO1, L1
10. Discuss the pond management practices of *Macrobrachium rosenbergii* CO3, L2
OR
Describe the seed production methods in *Macrobrachium malcolmsonii* CO3, L2
11. Discuss the culture methods of sea bass. CO4, L2
OR
Explain the biology and culture of milk fish. CO4, L2
12. Describe the hatchery technology of *L.vennamei*. CO5, L1
OR
List out the various diseases of *P.monodon* add a note on prophylaxis and treatment.
CO5, L1
13. Write an essay on pearl oyster culture CO6, L1
OR
Explain the culture aspects of mud crab. CO6, L1

A.G. & S.G.SIDDHARTHA DEGREE COLLEGE OF ARTS & SCIENCE, VUYYURU-521165,
KRISHNA Dt.,A.P. (AUTONOMOUS)

AQUACULTURE
PRACTICAL - III

w.e.f. 2022-2023.

Code: AQTP31A

MAX.MARKS: 50.

(2hrs/week)

PRACTICAL SYLLABUS

PRACTICALS:

1. Identification of important cultivable fresh water fishes (carps, cat fishes and Murrells)
2. Identification of important cultivable brackish water fishes
3. Identification of important cultivable fresh water prawns
4. Identification of important cultivable brackish water prawns
5. Identification of commercially viable crabs – *Scyllaserrata*,
Portunuspelagicus, *P.sanguinolentus*, *Neptunuspelagicus*, *N.Sanguinolentus*
6. Identification of oysters of nutritional significance – *Crossostrea madrasensis*,
C.gryphoides, *C. cucullata*, *C.rivularis*, *Picnodanta*.
7. Morph types of *Macro brachiumrosenbergii*
8. Identification of crustacean larval sequences (shrimp and crab)
9. Identification of diseases of *L. vennamei* and *P. monodon*
10. Field visit to freshwater/brackish water/prawn/shrimp farm and study of culture aspects.

Demonstration of dissection / dissected / virtual dissection:

1. *Channa*- Reproductive system
2. Shrimp – Reproductive system (Identification of male & female)

PRESCRIBED BOOK(S):

1. Jhingran VG 1998. Fish and Fisheries of India, Hindustan Publishing Corporation, New Delhi

REFERENCES:

1. Santhanam R, NSukumar and PNatarajan 1987. A Manual of Aquaculture, Oxford- IBH, New Delhi
2. Srivatsava 1993. Fresh water Aquaculture in India, Oxford-IBH, New Delhi
3. Marcel H 1972. Text book of Fish Culture. Oxford fishing news books

Practical - III

w.e.f. 2022 - 2023

Max. Marks: 40

Model Question Paper –External

Paper Code: AQTP31A

-
1. Identify and draw a neat labelled diagram of *Channa* reproductive system.
Or
Identify and draw a neat labeled diagram of prawn reproductive system. **10M**

Identification: 1M

Diagram: 4M

Labelling: 5M

2. Identify, classify, draw labelled diagram and comment on

5X3=15M

- A. Cultivable fresh water fish
- B. Cultivable prawn/shrimp
- C. Cultivable brackish water fish
- D. Cultivable shell fish (crabs and oysters)
- E. Shrimp/prawn disease

Identification: 1M

Diagram: 1M

Notes: 1M

- 3. Field Note Book **5M**
- 4. Record Book **5M**
- 5. VIVA **5M**

SEMESTER V - APPRENTICESHIP

**A.G& S.G.SIDDHARTHA DEGREE COLLEGE OF ARTS &
SCIENCE**

VUYYURU-521165, KRISHNA Dt., A.P.(Autonomous)

Accredited by NAAC with "A" Grade

2022-2023



DEPARTMENT OF BOTANY

MINUTES OF BOARD OF STUDIES

OOD SEMESTER

27-10-2022

**ADUSUMILLI GOPALAKRISHNAIAH & SUGAR CANE GROWERS SIDDHARTHA DEGREE
COLLEGE OF ARTS & SCIENCE, VUYYURU-521165, KRISHNA Dt., A.P. (AUTONOMOUS).**

NAAC recredited at 'A' level
Autonomous -ISO 9001-2015 Certified
DEPARTMENT OF BOTANY
BOARD OF STUDIES MEETING: 27th October 2022

The Board of studies meeting of Department of Botany was convened at 2:00 pm on 27/10/2022 under the chairmanship of Smt.Ch.Beulah Ranjani Head of the Department .The members present have discussed various aspects such as changes to be made in the syllabi, scheme of Evaluation and Blue print both for theory and practical papers, Departmental activities for 2022-2023 ,Estimated Budget proposals 2022-2023 for implementing them effectively during the I,III,& V semester for the academic year 2022-2023 onwards.

The following members were present.

S.No	Name	Designation	signature
1.	Smt. Ch. Beulah Ranjani Head, Department of Botany A.G&S.G.S Degree College Vuyyuru.	Chair person	<i>Ch. Beulah Ranjani</i>
2	prof. Avasan Maruthi Bio Sciences & Bio technology Krishna University Machilipatnam.	University Nominee	<i>J. Beulah</i>
3.	Sri Dr. Ch. Srinivasa Reddy Lecturer in Botany SRR & CVR Govt. Degree College, Vijayawada.	Subject Expert	<i>Ch. Srinivasa Reddy</i>
4.	P. Srinivasa Rao Department of Botany, P.B. Siddhartha College,	Subject Expert	<i>P. Srinivasa Rao</i>
5.	Sri. S. Krishna Suman, Natural farmer, yakamuru Vuyyuru.	Industrialist	<i>S. Krishna Suman</i>
6.	Sri. N. Ramana Rao Lecturer in Botany, A.G &S.G.S Degree College Vuyyuru.	Member	<i>N. Ramana Rao</i>
7.	Miss. G. Rebecca Rachel Lecturer in Botany, A.G&S.G.S Degree College Vuyyuru.	Member	<i>G. Rebecca Rachel</i>
8.	Miss. K. Anusha Lecturer in chaitnya college, Gudiwada.	Student Represent	<i>K. Anusha</i>

Agenda for B.O.S Meeting.

1. To recommend the syllabi (Theory & Practical), Model question paper for I Semester of I B.Sc (B.Z.C, Aqua) for the academic year 2022 - 2023.
2. To recommend the syllabi (Theory & Practical), Model question paper for III Semester of II B.Sc (B.Z.C, Aqua) for the academic year 2022 - 2023.
3. To introduce Skill enhancement Course the syllabi (Theory & Practical), Model question paper for V Semester of III B.Sc (B.Z.C, Aqua) for the academic year 2022 - 2023.
4. To recommend the Blue print for the semester end exam for I, III & V semester of I,II, III B.Sc (B.Z.C, Aqua) for the academic year 2022 - 2023.
5. To recommend the teaching and evolution methods to be followed under Autonomous status.
6. Any other matter.

RESOLUTIONS

1. It is resolved to continue the same syllabi (Theory & Practical), model question paper & guide lines to be followed by the question paper setters of Botany of I semester of I B.Sc. (B.Z.C, Aqua) under Choice Based Credit System (CBCS) approved by the Academic Council of 2022 – 2023
2. It is resolved to implement the syllabi (Theory & Practical), model question paper & guide lines to be followed by the question papers under Choice Based Credit System (CBCS) setters of Botany of III Semester of II B.Sc. (B.Z.C, Aqua) approved by the Academic Council of 2022 –2023.
3. It is resolved to implement changed syllabi & model papers under Choice Based Credit System (CBCS) Setters of Botany of V semester SEC 6C (Plant tissue culture) and SEC 7C (Mushroom cultivation) of III B.Sc. (B.Z.C, Aqua) approved by the Academic Council of 2022-2023.
4. It is resolved to Continue the same Blue prints of I, III, & V Semesters of B.Sc Botany for the Academic year 2022-2023.
5. is resolved to continue the following teaching & evolution methods for the Academic year 2022-23.
6. Any other matter.

Teaching methods:

Besides the conventional methods of teaching, we use modern technology i.e. Using of OHP and LCD projector to display on U boards etc; for better understanding of concepts.

Evaluation of a student is done by the following procedure:

Internal Assessment Examination:

- Out of maximum 100 marks in each paper for I, III B.Sc, 30 marks shall be allocated for internal assessment.
- Out of these 30 marks, 20 marks are allocated for announced tests (i.e . IA-1& IA-2). Two announced tests will be conducted and average of these two tests shall be deemed as the marks obtained by the student, 5 marks are allocated on the basis of candidate's percentage of attendance and remaining 5 marks are allocated for the assignment for I, III B.SC.
- Out of maximum 100 marks in each paper for II B.Sc, 25 marks shall be allocated for internal assessment.
- Out of these 25 marks, 15 marks are allocated for announced tests (i.e . IA-1& IA-2). Two announced tests will be conducted and average of these two tests shall be deemed as the marks obtained by the student, 5 marks allocated on the basis of candidate's percentage of attendance / assignment for II semester.
- There is no pass minimum for internal assessment for I, II, III B.Sc.

- **Semester – End Examination:**

- The maximum mark for II (BZC) semester – End examination shall be 75 marks and duration of the examination shall be 3 hours.
- The maximum mark for I, III B.Sc semester- End examination shall be 70 marks and duration of the examination shall be 3 hours. Even through the candidate is absent for two IA exams / obtain zero marks the external marks are considered (if the candidate gets 40/70) and the result shall be declared as “PASS”
- Semester – End examination shall be conducted in theory papers at the end of every semester, while in practical papers, these examinations are conducted at the end of I, III, & V semester for I, II & III B.Sc.
- Discussed and recommended for organizing Seminars, Guest lectures, Work – Shops to upgrade the Knowledge of students, for the approval of the Academic Council.

Ch. Beulah Rajani
Chairman

Course Structure of BZC, AQUA Syllabus

year	semester	Paper code	Title of the paper	Marks(100)		Credits
				Internal assessment	End semester	
I	I	BOTIIA	Fundamentals of Microbes and Non-vascular plants	30	70	3
			Practical-I	10	40	2
II	III	BOTT31A	Anatomy of angiosperms, Plant Ecology and Biodiversity	25	75	3
			Practical-III	25	25	2
III	V	BOT-501	Plant tissue culture.	30	70	3
			Practical-v – 501	25	25	2
III	V	BOT-502	Mushroom Cultivation	30	70	3
			Practical-v- 502	25	25	2

ADUSUMILLI GOPALAKRISHNAIAH & SUGAR CANE GROWERS SIDDHARTHA DEGREE COLLEGE OF ARTS & SCIENCE, VUYYURU-521165, KRISHNA Dt., A.P. (AUTONOMOUS).

NAAC reaccredited at 'A' level

Autonomous –ISO 9001-2015 Certified

Title of the Paper: **Fundamentals of Microbes and Non-vascular Plants**

Semester: - I

Course Code	BOTT11A	Course Delivery Method	Class Room/Blended Mode - Both
Credits	3	CIA Marks	30
No. of Lecture Hours/ Week	4	Semester End Exam Marks	70
Total Number of Lecture Hours	60	Total Marks	100
Year of Introduction : 2021-22	Year of Offering 2021-2022	Year of Revision –	Percentage of Revision: 0%

Course Prerequisites: Knowledge of microbes, thallophytes and Bryophytes at +2 level

Course Description: This course emphasizes the student to understand origin of life on earth and analyze structure, disease symptoms and transmission of plant viruses. Enhance one with the knowledge in diversity and characteristics of prokaryotes, characteristics of fungi and lichens, algae and bryophytes.

Course Objectives:

On successful completion of this course, the students will be able to:

1. To understand origin of life on the earth and analyze structure, disease symptoms and transmission of plant viruses.
2. To understand the diversity and characteristics of Prokaryotes.
3. To understand the characteristics of Fungi and Lichens.
4. To understand the characteristics of Algae.
5. To understand the characteristics of Bryophyta.

Course Outcomes: At the end of this course, students should be able to:

CO1: Explain origin of life on the earth.

CO2: Illustrate diversity among the viruses and prokaryotic organisms and can categorize them.

CO3: Analyze and ascertain the plant disease symptoms due to viruses, bacteria and fungi.

CO4: Classify fungi, lichens, algae and bryophytes based on their structure, reproduction and life cycles.

CO5: Evaluate the ecological and economic value of microbes, thallophytes and bryophytes.

Syllabus

Course Details

Unit	Learning Units	Hours
I	<p>Origin of life and viruses Origin of life, concept of primary Abiogenesis; Miller and Urey experiment. Five kingdom classifications of R.H. Whittaker. Discovery of micro- organisms, Pasteur experiments, germ theory of diseases. Shape and symmetry of viruses; structure of TMV and Gemini virus; multiplication of TMV, a brief account of Prions and Viroids. A general account on symptoms of plant diseases caused by Viruses. Transmission of plant viruses and their control. Significance of viruses in vaccine production, bio-pesticides and as cloning vectors.</p>	12
II	<p>Special groups of Bacteria and Eubacteria Brief account of Archaeobacteria, Actinomycetes and Cyano bacteria. Cell structure and nutrition of Eubacteria. Reproduction- Asexual (Binary fission and endospores) and bacterial recombination.(Conjugation, Transformation, Transduction). Economic importance of Bacteria with reference to their role in Agriculture and industry (fermentation and medicine). A general account on symptoms of plant diseases caused by Bacteria; Citrus canker.</p>	12
III	<p>Fungi & Lichens General characteristics of fungi and Ainsworth classification (up to classes). Structure, reproduction and life history of (a)<i>Rhizopus</i> (Zygomycota) and (b)<i>Puccinia</i> (Basidiomycota). Economic uses of fungi in food industry, pharmacy and agriculture. A general account on symptoms of plant diseases caused by Fungi; Blast of Rice. Lichens- structure and reproduction; ecological and economic importance.</p>	12
IV	<p>Algae General characteristics of Algae (pigments, flagella and reserve food material), Fritsch classification (up to classes). Thallus organization and life cycles in Algae. Occurrence, structure, reproduction and life cycle of (a)<i>Spirogyra</i> (Chlorophyceae) and (b) <i>Polysiphonia</i>(Rhodophyceae). Economic importance of Algae.</p>	12
V	<p>Bryophytes General characteristics of Bryophytes; classification up to classes. Occurrence, morphology, anatomy, reproduction (developmental details are not needed) and life cycle of (a) <i>Marchantia</i>(Hepaticopsida) and (b) <i>Funaria</i>(Bryopsida). General account on evolution of sporophytes in Bryophyta.</p>	12

Textbook:

1. Botany – I (Vrukshasastram-I): Telugu Akademi, Hyderabad
2. Pandey, B.P. (2013) *College Botany, Volume-I*, S. Chand Publishing, New Delhi

Recommended Reference book:

1. Prescott, L. Harley, J. and Klein, D. (2005) *Microbiology, 6th edition*, Tata McGraw –Hill Co. New Delhi.
2. Alexopoulos, C.J., C.W.Mims&M.Blackwell(2007)*Introductory Mycology*, Wiley& Sons, Inc., New York.
3. Fritsch, F.E. (1945) *The Structure & Reproduction of Algae (Vol. I &Vol.II)* Cambridge University Press Cambridge, U. K.

Course Delivery method: Face-to-face / Blended.

Course has focus on: Foundation.

Websites of Interest:

<https://www.youtube.com/watch?v=SkC1CX9FfiY>

<https://www.youtube.com/watch?v=h57UuVdyyLk>

<https://www.youtube.com/watch?v=OBej7iFyN7U>

https://www.youtube.com/watch?v=7sZ5Nz8_cfc

Co-curricular Activities:

1. Question and answer session at the end of class.
2. Observing animations.
3. Written assignments.
4. Collection and identification of Algae from Fresh water.
5. Collection and identification of diseased plant parts.
6. Group Discussion (GD)/ Quiz.
7. Power Point Presentations.

(An Autonomous college in the jurisdiction of Krishna University

MODEL QUESTION PAPER- Theory Examination(s) at Semester end 2021-2022

TITLE OF THE PAPER: Fundamentals of Microbes and Non-vascular Plants

(Viruses, Bacteria, Fungi, Lichens, Algae and Bryophytes)

Max. Time: 3 Hrs.

Course Code: BOTT11A

Max. Marks: 70M

Section-A

1. (a) i) Give an account of structure and multiplication of TMV? **(10M) CO1- L2.**
ii) Five kingdom classification of Whittaker. **(4M) CO1-L2.**
OR
b) i) Explain the significance of viruses in vaccine production, bio-pesticides and as cloning vectors. **(10M) CO1-L2.**
ii) Germ theory of diseases. **(4M) CO1-L2.**
2. (a) i) whether bacteria exhibit sexual reproduction or not? Elucidate different methods of bacterial recombination. **(10M)CO2 - L2.**
ii) What are the symptoms of citrus canker? Mention the causal organism of citrus canker. . **(4M) CO2 - L2**
OR
b) i) Explain the role of bacteria in agriculture and industry. **(10M)CO2 - L2.**
ii) General characters of blue – green algae. . **(4M) CO-3 L2**
- 3(a) i) Why *Puccinia* is called as macro cyclic rust? Explain the stages of the fungus on Primary host. **(10M) CO3-L1.**
ii) Ainsworth classification of fungi **CO-3 L2 .(4M)**
OR
b) i) Why lichens are considered as ‘pioneers of colonization’? Give an account of ecological and economic Importance of lichens. **CO3 -L1. (10M)**
ii) Why lichens are considered as unique and composite organisms? **CO-3 L1. .(4M)**
- 4.(a)i) What is thallus? Describe various types of thalli found in algae. **(10M) CO4 -L2.**
ii) General characters of algae. **CO-3 L2.(4M)**
OR
b) i) Explain life cycle of *Spirogyra* .**CO-4 L2. (10M)**
ii) Explain about Cystocarp. **CO-4 L2. .(4M)**
- 5(a)i) Describe morphological and anatomical features of *Marchantia*.**CO5- L2. (10M)**
ii) Vegetative reproduction in Bryophytes. **CO5 - L2. .(4M)**
OR
b) i) Give account on of sporophyte evolution in Bryophytes. **CO5 -L 2 (10M).**
ii) Describe the gametophyte phase in *Funaria* **CO5- L2. .(4M)**

A.G & S.G. SIDDHARTHA DEGREE COLLEGE OF ARTS AND SCIENCE, VUYYURU
(An Autonomous college in the jurisdiction of Krishna University)

Practical Syllabus

SEMESTER- I

PAPER- I

CREDITS : 02

BOTANY	BOTT11A	WEF: 2021-2022	B. Sc (BZC), AQUA
---------------	----------------	-----------------------	--------------------------

Title of the paper: Fundamentals of Microbes and Non-vascular Plants

(Viruses, Bacteria, Fungi, Lichens, Algae and Bryophytes)

NO OF HOURS: 30

Course Prerequisites: Knowledge of microbes, thallophytes and Bryophytes at +2 level

Course Description: This course emphasizes the student to understand origin of life on earth, analyze and identify the structure, disease symptoms and transmission of plant viruses. Enhance one with the skill in identifying diversity and characteristics of prokaryotes, characteristics of fungi and lichens, algae and bryophytes.

Course Objectives:

On successful completion of this course, the students will be able to:

1. To understand origin of life on the earth and analyze structure, disease symptoms and transmission of plant viruses.
2. To understand the diversity and characteristics of Prokaryotes.
3. To understand the characteristics of Fungi and Lichens.
4. To understand the characteristics of Algae.
5. To understand the characteristics of Bryophyta.

Course Outcomes: At the end of this course, students should be able to:

CO1: Explain origin of life on the earth.

CO2: Illustrate diversity among the viruses and prokaryotic organisms and can categorize them.

CO3: Analyze and ascertain the plant disease symptoms due to viruses, bacteria and fungi.

CO4: Classify fungi, lichens, algae and bryophytes based on their structure, reproduction and life cycles.

CO5: Evaluate the ecological and economic value of microbes, thallophytes and bryophytes.

Syllabus

Course Details:

Unit	Learning Units	Lecture Hours
I	<p>Knowledge of Microbiology laboratory practices and safety rules. Knowledge of different equipment for Microbiology laboratory (Spirit lamp, Inoculation loop, Hot-air oven, Autoclave/Pressure cooker, Laminar air flow chamber and Incubator) and their working principles. (In case of the non- availability of the laboratory equipment the students can be taken to the local college/clinical lab. with required infrastructural facilities or they can enter a linkage with the college/lab for future developments and it will fetch credits during the accreditation by NAAC).</p> <p>Demonstration of Gram's staining technique for Bacteria.</p> <p>Study of Viruses (Corona, Gemini and TMV) using electron micrographs/ models.</p>	6
II	<p>Study of Archaeobacteria and Actinomycetes using permanent slides/ electron micrographs/diagrams. Study of <i>Anabaena</i> and <i>Oscillatoria</i> using permanent/temporary slides. Study of different bacteria (Cocci, Bacillus, Vibrio and Spirillum) using permanent or temporary slides/ electron micrographs/ diagrams.</p>	4
III	<p>Study/ microscopic observation of vegetative, sectional/anatomical and reproductive structures of the following using temporary or permanent slides/ specimens/ mounts: a. Fungi: <i>Rhizopus</i>, <i>Penicillium</i> and <i>Puccinia</i> Lichens: Crustose, foliose and fruticose.</p>	10
IV	<p>Algae: <i>Volvox</i>, <i>Spirogyra</i>, <i>Ectocarpus</i> and <i>Polysiphonia</i>. Bryophyta: <i>Marchantia</i> and <i>Funaria</i> Study of specimens of Tobacco mosaic disease, Citrus canker and Blast of Rice.</p>	10

Recommended Reference book:

1. Vasista, B.R. (2018). Botany for degree students - Algae - S. Chand and company Ltd., New Delhi.
2. Dubey, H.C (2018). A text book of Fungi, bacteria and Viruses. Vikas publishing House, New Delhi.
3. Smith, G.M (1955). Cryptogamic Botany (Vol. I Algae, Fungi, & Lichens) McGraw-Hill Book Co., New York.

Course Delivery method: Face-to-face / Blended.

Course has focus on: Skill Development.

Websites of Interest:

<https://youtu.be/KXtGkIXMCQU>

<https://youtu.be/u3BVke4C8Sc>

<https://youtu.be/q7vwDDKugN0>

<https://youtu.be/1VXSjF16KXg>

<https://youtu.be/xtf0suS4vek>

<https://youtu.be/o77dGAToV3U>

<https://youtu.be/Edmev8lQxLM>

https://youtu.be/ks8j2_iawVU

<https://youtu.be/n4jtCgpXZVI>

<https://youtu.be/2kY7uzeYWFc>

<https://youtu.be/fvEJpipMWUs>

https://youtu.be/KAlvzK_391s

Co-curricular Activities:

1. Question and answer session at the end of class.
2. Observing animations.
3. Collection and identification of Algae from Fresh water.
4. Collection and identification of diseased plant parts.
5. Group Discussion (GD)/ Quiz.
6. Power Point Presentations.

Model Question Paper Structure for SEE

Max: 40 Marks

Min. Pass: 16 Marks

-
1. Take the T.S. of material 'A' (Fungi), make a temporary mount and make comments about identification.....8M.
 2. Identify any 2 algae from the mixture (material 'B') given with specific comments about identification.....8M
 3. Take the T.S. of material 'C' (Bryophyta), make a temporary mount and make comments about identification.....8M
 4. Identify the following with specific reasons.....4X2=8M
 - A. laboratory equipment of Microbiology
 - B. Virus
 - C. Archaeobacteria /Ascomycete /Cyanobacteria/ Eu-Bacteria
 - D. Lichen
 1. Record + Viva-voce.....5+3 = 8M

CIA 10 M

**ADUSUMILLI GOPALAKRISHNAIAH & SUGAR CANE GROWERS SIDDHARTHA
DEGREE COLLEGE OF ARTS & SCIENCE, VUYURU-521165, KRISHNA Dt., A.P.
(AUTONOMOUS).**

Title of the Paper: **(Anatomy and Embryology of Angiosperms, Plant Ecology and Biodiversity)**

Semester: - III

Course Code	BOTT31A	Course Delivery Method	Class Room/Blended Mode - Both
Credits	3	CIA Marks	25
No. of Lecture Hours/ Week	4	Semester End Exam Marks	75
Total Number of Lecture Hours	60	Total Marks	100
Year of Introduction : 2021-22	Year of Offering 2021-2022	Year of Revision –	Percentage of Revision: 0%

Course Prerequisites: Knowledge of Anatomy and Embryology of angiosperms, Plant Ecology and Biodiversity at +2 level.

Course Description: This course will provide one with a basic and comprehensive understanding of anatomical structure and functions. Enable the student with depth of topics and helps them to gain an appreciation in the embryology of Angiosperms. On the other hand, importance of understanding plant ecology and biodiversity provides an extensive knowledge to the student.

Course Objectives:

On successful completion of this course, the students will be able to:

1. To understand the Anatomy of Angiosperms.
2. To understand the Embryology of Angiosperms.
3. To understand the Basics of Ecology.
4. To understand the Population Community and Production Ecology.
5. To understand the Basics of Biodiversity.

Course Outcomes: At the end of this course, students should be able to:

CO1: Understand on the organization of tissues and tissue systems in plants.

CO2: Illustrate and interpret various aspects of embryology.

CO3: Discuss the basic concepts of plant ecology, and evaluate the effects of environmental and Biotic factors on plant communities.

CO4: Appraise various qualitative and quantitative parameters to study the population and community ecology.

CO5: Correlate the importance of biodiversity and consequences due to its loss and enlist the Endemic /endangered flora and fauna from two biodiversity hot spots in India and assess strategies for their conservation.

Syllabus

Course Details

Unit	Learning Units	Lecture Hours
I	<p>Anatomy of Angiosperms Organization of apical meristems: Tunica-carpus theory and Histogen theory. Tissue systems–Epidermal, ground and vascular. Anomalous secondary growth in <i>Boerhavia</i> and <i>Dracaena</i>. Study of timbers of economic importance -Teak, Redsanders and Rosewood.</p>	12
II	<p>Embryology of Angiosperms History of embryology, Structure of anther, types of tapetum. Micro sporogenesis and development of male gametophyte. Structure of ovule, megaspore genesis; monosporic (<i>Polygonum</i>), bi sporic (<i>Allium</i>) and tetra sporic (<i>Peperomia</i>) types of embryo sacs. Outlines of pollination, pollen– pistil interaction and fertilization. Endosperm – Types and biological importance Free nuclear, cellular, helobial and ruminant. Development of Dicot (<i>Capsella bursa-pastoris</i>) embryo.</p>	12
III	<p>Basics of Ecology Ecology: definition, branches and significance of ecology. Ecosystem: Concept and components, energy flow, food chain, food web, ecological pyramids. Plants and environment: Climatic (light and temperature), edaphic and biotic factors. Ecological succession: Hydrosere and Xerosere.</p>	12
IV	<p>Population, Community and Production Ecology Population ecology: Natalty, mortality, growth curves, ecotypes, ecads. Community ecology: Frequency, density, cover, life forms, biological spectrum. Concepts of productivity: GPP, NPP and Community Respiration. Secondary production, P/R ratio.</p>	12
V	<p>Basics of Biodiversity Biodiversity: Basic concepts, Convention on Biodiversity-Earth Summit. Value of Biodiversity; types and levels of biodiversity and Threats to biodiversity. Biodiversity Hot spots in India. Biodiversity in Eastern Ghats and Western Ghats. Principles of conservation: IUCN threat-categories, RED data book. Role of NBPGR and NBA in the conservation of Biodiversity.</p>	12

Textbook:

- Botany–III(Vrukshasastram-I) : Telugu Akademi, Hyderabad
- Botany–IV(Vrukshasastram-II) : Telugu Akademi, Hyderabad
- Pandey,B.P. (2013)*CollegeBotany, Volume-II*, S. Chand Publishing, NewDelhi
- Pandey,B.P. (2013)*CollegeBotany, Volume-III*,S. Chand Publishing, New Delhi

Recommended Reference book:

- Esau, K. (1971) *Anatomyof Seed Plants*.JohnWileyand Son, USA.
- Fahn, A.(1990) *Plant Anatomy*, Pergamon Press,Oxford.
- Cutler, D.F., T.Botha& D. Wm. Stevenson (2008) *Plant Anatomy: An Applied Approach*, Wiley, USA.
- Paula Rudall(1987) *Anatomyof Flowering Plants: An Introduction to Structure and Development*.CambridgeUniversityPress,London.

Course Delivery method: Face-to-face / Blended.

Course has focus on: Foundation Websites of Interest:

<https://byjus.com/biology/tissues-anatomy-of-angiosperms/>

https://onlinecourses.swayam2.ac.in/cec21_bt22/preview

<https://explorenaturalcommunities.org/ecology-basics#:~:text=Ecology%20is%20the%20science%20of,and%20with%20their%20physical%20environment.>

[https://en.wikipedia.org/wiki/Community_\(ecology\)](https://en.wikipedia.org/wiki/Community_(ecology))

https://ec.europa.eu/environment/basics/natural-capital/biodiversity/index_en.htm#:~:text=%22Biodiversity%22%20is%20a%20word%20we,their%20habitats%20and%20their%20genes.&text=Much%20food%20production%20is%20only,that%20pollinate%20plants%20and%20trees.

Co-curricular Activities:

Question and answer session at the end of class. Observing animations.

Written assignments.

Preparation of models.

Making charts

Group Discussion (GD) /

Quiz.

Power Point

Presentations.

A .G & S .G. SIDDHARTHA DEGREE COLLEGE OF ARTS AND SCIENCE, VUYURU

(An Autonomous college in the jurisdiction of Krishna University)

TITLE OF THE PAPER: Anatomy and Embryology of Angiosperms, Plant Ecology and Biodiversity.

Model Question Paper Structure for SEE

Max. Time: 3 Hrs.

Course Code: BOTT31A

Max. Marks: 75M

Section-A

Answer Any Five at least one from each unit

5 x 5M = 25Marks

1. Tunica corpus theory. **CO1L1**
2. Rose wood. **CO1L2**
3. Nemec phenomenon. **CO2L2**
4. Ruminant endosperm. **CO2L2**
5. Food chain & Food web. **CO3L1**
6. Ecads. **CO4L2**
7. Earth summit. **CO5L1**
8. Identify Biodiversity hot spots of India **CO5L3**.

Section-B

Answer the following questions

5 x 10M = 50Marks

9. (a) Describe the epidermal tissue system. **CO1L1**
or **Unit I**
(b) What is anomalous secondary growth? Describe the anomalous secondary growth in *Boerhavia* stem. **CO1L1**
10. (a) What is embryosac? How many types are there? Explain the development of embryosac studied by you. **CO2L2. Unit II**
or
(b) Explain the development of embryo **CO2L2**
11. (a) What is an ecosystem? Give an account of structure of an ecosystem studied by you. **CO3L1**
or **Unit III**
(b) What is succession? Give account of xerosere. **CO3L1**
12. (a) What is population ecology? Explain characters of a population studied by you. **CO4L2**
or **Unit IV**
(b) List out the quantitative and qualitative characters of community. Explain? Qualitative characters of a plant community. **CO4L2**
13. (a) Classify and analyse main values of biodiversity. **CO5L4**
or **Unit V**
(b) Analyse the major threats to biodiversity. **CO5L4**

A .G & S .G. SIDDHARTHA DEGREE COLLEGE OF ARTS AND SCIENCE, VUYYURU
(An Autonomous college in the jurisdiction of Krishna University)

Practical Syllabus

SEMESTER- III

PAPER- III

CREDITS: 02

BOTANY	BOTT3IA	WEF: 2022-2023	B. Sc (BZC), AQUA
---------------	----------------	-----------------------	--------------------------

Title of the paper: Anatomy and Embryology of Angio sperms, Plant Ecology and Biodiversity

NO OF HOURS: 30

Course Prerequisites: Knowledge of Anatomy and Embryology of angiosperms, Plant Ecology and Biodiversity at +2 level.

Course Description: This course will provide one with a basic and comprehensive understanding and skill of identifying anatomical structure and functions. Enable the student with depth of topics and helps them to gain an appreciation in the embryology of Angiosperms. On the other hand, importance of understanding plant ecology and biodiversity provides an extensive knowledge to the student.

Course Objectives:

On successful completion of this course, the students will be able to:

1. To understand the Anatomy of Angiosperms.
2. To understand the Embryology of Angiosperms.
3. To understand the Basics of Ecology.
4. To understand the Population Community and Production Ecology.
5. To understand the Basics of Biodiversity.

Course Outcomes:

On successful completion of this practical course students shall be able to:

1. Get familiarized with techniques of section making, staining and microscopic study of vegetative, anatomical and reproductive structure of plants.
2. Observe externally and under microscope, identify and draw exact diagrams of the material in the lab.
3. Demonstrate application of methods in plant ecology and conservation of biodiversity and Qualitative and quantitative aspects related to populations and communities of plants.

Syllabus

Course Details:

Unit	Learning Units	Lecture Hours
I	Tissue organization in root and shoot apices using permanent slides. Anomalous secondary growth in stems of <i>Boerhavia</i> and <i>Dracaena</i> .	4
II	Study of anther and ovules using permanent slides/photographs. Study of pollen germination and pollen viability. Dissection and observation of Embryo sac haustoria in <i>Santalum</i> or <i>Argemone</i> . Structure of endosperm (nuclear and cellular) using permanent slides / Photographs. Dissection and observation of Endosperm haustoria in <i>Crotalaria</i> or <i>Coccinia</i> . Developmental stages of dicot and monocot embryos using permanent slides /photographs.	12
III	Study of instruments used to measure microclimatic variables; soil thermometer, maximum and minimum thermometer, anemometer, rain gauge, and luxmeter. (Visit to the nearest/local meteorology station where the data is being collected regularly and record the field visit summary for the submission in the practical). Study of morphological and anatomical adaptations of hydrophytes and xerophytes (02 each).	6
IV	Quantitative analysis of herbaceous vegetation in the college campus for frequency, density and abundance. Identification of vegetation/various plants in college campus and comparison with Raunkiaer's frequency distribution law.	6
V	Find out the alpha- diversity of plants in the area.	2

Recommended Reference book:

1. Practical Botany volume II- Bendra and Kumar.
2. Practical Botany volume II-O.P.Sharma.
3. Practical Botany volume III-H.N.Srivastava.
4. Khasim SM., Botanical Microtechnique- Principles & Practice, Capital Publishing Company.

Course Delivery method: Face-to-face / Blended.

Course has focus on: Skill Development.

Websites of Interest:

<https://youtu.be/iA5EqQm3hqw>

https://youtu.be/_3K2qLw_z_U

<https://youtu.be/ZIF4NTDL14U>

<https://youtu.be/qPUPw7iS86Q>

https://youtu.be/qGLo_cUMIHU

<https://youtu.be/Spl9GWgXJPQ>

<https://youtu.be/ifAdxMspJGY>

<https://youtu.be/K86XXQdwIB4>

<https://youtu.be/c83EtBUrWsk>

<https://youtu.be/enD2OwXBhCM>

<https://youtu.be/M-TczeGvCCg>

<https://youtu.be/dDrrTbi88zE>

<https://youtu.be/aX58F5jWxU8>

<https://youtu.be/rSsFn1GEuyw>

Co-curricular Activities:

Question and answer session at the end of class.

Observing animations.

Written assignments. Preparation of temporary slides. Group

Discussion (GD)/ Quiz.

Power Point Presentations.

Practical Model Question Paper

Max.: 40 Marks

Min. Pass: 16 Marks

.....

1. Take T.S of the given material 'A' (Anatomy), prepare a temporary slide and justify the identification with specific reasons.....**8M**
2. Write the procedure for the experiment 'B' (Embryology) and demonstrate the same...**8M**
3. Take T.S of the material 'C'. Prepare a temporary slide and justify the identification with specific reasons.....**8M**
4. Identify the following with specific reasons.....**4x2=8**

-
- D. Anatomy/Embryology
 - E. Ecology instrument
 - F. Mapping of Biodiversity hot spot.
 - G. Endemic/endangered plant/animal

-
5. Record +Viva-voce.....**5+3=8 M**

**ADUSUMILLI GOPALAKRISHNAIAH & SUGAR CANE GROWERS SIDDHARTHA
DEGREE COLLEGE OF ARTS & SCIENCE, VUYURU-521165, KRISHNA Dt., A.P.
(AUTONOMOUS).**

NAAC reaccredited at 'A' level
Autonomous –ISO 9001-2015 Certified

Title of the Paper: **Plant tissue culture**

Semester: - V

Course Code	BOT 501	Course Delivery Method	Class Room/Blended Mode - Both
Credits	3	CIA Marks	30
No. of Lecture Hours/ Week	3	Semester End Exam Marks	70
Total Number of Lecture Hours	50	Total Marks	100
Year of Introduction : 2022-23	Year of Offering 2022-2023	Year of Revision –	Percentage of Revision: 0%

Type of the Course: Skill Enhancement Course (Elective: Theory),

Course Outcomes: Students at the successful completion of the course will be able to:

CO1: Comprehend the basic knowledge and applications of plant tissue culture.

CO2: Identify various facilities required to set up a plant tissue culture laboratory.

CO3: Acquire a critical knowledge on sterilization techniques related to plant tissue culture.

CO4: Demonstrate skills of callus culture through hands on experience.

CO5: Understand the biotransformation technique for production of secondary metabolites.

- References/TextBook/ e-books/websites:

1. Razdan, M.K. (2005) Introduction to Plant Tissue Culture, Oxford & IBH Publishers, Delhi
2. Bhojwani, S.S. (1990) Plant Tissue Culture: Theory and Practical (a revised edition). Elsevier Science Publishers, New York, USA.

ReferenceMaterials ontheWeb/web links:

<https://www.youtube.com/watch?v=dFrX-t5JOPA>

<https://www.youtube.com/watch?v=A6qEgc6Jt3Q>

Co-CurricularActivities

(a) Mandatory:(Training of students by teacher in field related skills:(lab:10 + field: 05)

1. **For Teacher:** Training of students by teacher in the laboratory/field for a total of not less than 15 hours on the field techniques/skills of sterilization procedures, preparation of media, establishment of callus culture, growth measurements; morphogenesis and organogenesis; acclimatization and hardening of plantlets.

2. **For Student:** Students shall (individually) visit anyone of plant tissue culture laboratories in universities/research organizations/private facilities, write their observations on tools, techniques, methods and products of plant tissue culture; and submit a hand-written Fieldwork/Project work Report not exceeding 10 pages to the teacher in the given format.

3. Max marks for Fieldwork/Project work Report: 05

4. Suggested Format for Fieldwork/Project work Report: Title page, student details, index page, details of place visited, observations, findings and acknowledgements.

5. Unit tests (IE).

b) Suggested Co-Curricular Activities:

1. Training of students by related industrial experts.
2. Assignments (including technical assignments like identifying tools in plant tissue culture and their handling, operational techniques with safety and security, IPR)
3. Seminars, Group discussions, Quiz, Debates etc. (on related topics).
4. Preparation of videos on tools and techniques in plant tissue culture.
5. Collection of material/figures/photos related to products of plant tissue culture, writing and organizing them in a systematic way in a file.
6. Visits to plant tissue culture/biotechnology laboratories in universities, research organizations, private firms, etc.
7. Invited lectures and presentations on related topics by field/industrial experts.

TITLE OF THE PAPER: PLANT TISSUE CULTURE

Model Question Paper

Max. Time: 3 Hrs.

Course Code: BOT-501

Max. Marks: 70M

.....
SECTION – A

Answer any FOUR of the following questions.

4x5=20 Marks

(Draw diagrams wherever necessary)

1. What is totipotency? Explain.
2. Describe the method of dry sterilization.
3. Enumerate the somaclonal variations.
4. Discuss about the virus indexing.
5. Prepare a note on cryoprotectants.
6. State a note on UV sterilization
7. What is an explant? Describe.
8. Describe the synthetic seeds in detail.

SECTION - B

Answer any Five of the following questions.

5x10 =50M.

(Draw diagrams wherever necessary)

9. Enumerate an account of Infrastructure and equipment required to establish a tissue culture laboratory.
10. Explain various methods of sterilization.
11. Discriminate an account of the composition and preparation of MS media.
12. Summarize an account of callus culture.
13. Paraphrase various ways of surface sterilization of explants
14. Illustrate about somatic embryogenesis.
15. Memorize the gene transfer methods.
16. State an account on secondary metabolite production through Bioreactors

Guide lines for paper setter: (for Paper V-BOT-501) W.e.f. 2022-23

1. In Section A: Unit II, III, VI, must carry Two questions from each unit. Unit I, V must carry one question.
2. In section-B: Set minimum two questions from Unit II, III & V and Set One Question from I, IV.
3. See the following table and Model paper.
4. Please provide the scheme of valuation for the paper.
5. Question paper should be both in English and Telugu media.

Unit	Section – A		Section - B		Weightage in
	Questions	Marks	Questions	Marks	Marks
Unit – I	1		1		
		5		10	15
Unit – II	2		2		
		10		20	30
Unit – III	2		2		
		10		20	30
Unit-IV	2		1		
		10		10	20
Unit-V	1		2		
		5		20	25
Max. Q & marks	8	(x 5) = 40	8	(x 10) = 80	(Total questions = 16) Marks 120
Max. Q and marks for Valuation	Questions	Marks	Questions	Marks	Max. marks
	4		5		
		(4 x 5) = 20		(5 x 10) = 50	70

INTERNAL EXAMS – 30 Marks

(20 marks for unit tests, 5 marks for assignments and remaining 5 marks for seminar etc.)

A .G & S .G. SIDDHARTHA DEGREE COLLEGE OF ARTS AND SCIENCE, VUYYURU
(An Autonomous college in the jurisdiction of Krishna University)

Practical Syllabus

SEMESTER- III

PAPER- II

CREDITS: 02

BOTANY	BOT- 501	WEF: 2022-2023	B. Sc (BZC), AQUA
---------------	-----------------	-----------------------	--------------------------

Title of the paper: **PLANT TISSUE CULTURE**

NO OF HOURS: 30

Type of the Course: Skill Enhancement Course (Elective: Practical),

I. Course Outcomes: Students at the successful completion of the course will be able to:

CO1: Demonstrate the applications of autoclave, laminar airflow, hot air oven.

CO2: Sterilize the glassware and tools used for tissue culturing.

CO3: Prepare different stock solutions, media.

CO4: Measure the growth of callus formed.

CO5: Demonstrate the hardening and acclimatization in green house.

II: Practical (Laboratory) Syllabus:(30Periods):Atleast8Practicals....

1. Principles and applications of- Autoclave, Laminar Airflow, Hot Air Oven.
2. Sterilization techniques for glass ware, tools etc.,
3. MS medium - Preparation of different stock solutions; media preparation
4. Explant preparation, inoculation and initiation of callus from carrot.
5. Callus formation, growth measurements.
6. Induction of somatic embryos, preparation of synthetic seeds.
7. Multiplication of callus and organogenesis.
8. Hardening and acclimatization in green house.

III. Lab References:

1. Reinert, J. and M.M. Yeoman, 1982. Plant Cell and Tissue Culture - A Laboratory
2. Manual, Springer-Verlag Berlin Heidelberg
3. Robert N. Trigiano and Dennis J. Gray, 1999. Plant Tissue Culture Concepts and Laboratory Exercises. CRC Press, Florida
4. Ashok Kumar, 2018. Practical Manual for Biotechnology, College of Horticulture & Forestry, Jhalawar, AU, Kota
5. Chawla, H.S., 2003. Plant Biotechnology: A Practical Approach, Nova Science Publishers, New York
6. Web sources suggested by the teacher concerned.

Practical Question Paper

Time : 3hrs

Max.Marks:50

-
- | | | |
|--|-----|--------------------|
| 1. Demonstration of a sterilization technique | 'A' | 5 M |
| 2. Preparation of MS medium | 'B' | 5 M |
| 3. Demonstration of callus culture technique/growth measurements | 'C' | 5M |
| 4. Scientific observation and data analysis | | 4 x 2 = 8 M |
| D. Tissue culture equipment /photograph | | |
| E. Morphogenesis or organogenesis - photograph | | |
| F. Bioreactor/Secondary metabolite | | |
| G. Transgenic plant/photograph | | |
| 5. Viva voce | | 2M |

Internals:

- | | |
|----------------------------|------|
| 1. Record | .05M |
| 2. Project work..... | 10M |
| 3. Field trip | .5M |
| 4. Internal practical exam | 05M |

Total Marks: 25

**ADUSUMILLI GOPALAKRISHNAIAH & SUGAR CANE GROWERS SIDDHARTHA
DEGREE COLLEGE OF ARTS & SCIENCE, VUYURU-521165, KRISHNA Dt., A.P.
(AUTONOMOUS).**

NAAC reaccredited at 'A' level
Autonomous –ISO 9001-2015 Certified

Title of the Paper: **mushroom cultivation (7C)**

Semester: - V

Course Code	SECBOT502	Course Delivery Method	Class Room/Blended Mode - Both
Credits	3	CIA Marks	30
No. of Lecture Hours/ Week	3	Semester End Exam Marks	70
Total Number of Lecture Hours	50	Total Marks	100
Year of Introduction : 2022-23	Year of Offering 2022-2023	Year of Revision –	Percentage of Revision: 0%

Course Outcomes: Students at the successful completion of the course will be able to:

CO1: Comprehend the value of mushrooms.

CO2: Identify the methods of composting and the materials required.

CO3: Acquire a critical knowledge on spawning and casing.

CO4: Demonstrate skills in cultivation of various mushrooms.

CO5: Understand the Post-harvest technology.

Syllabus: (Total Theory Hours: 45 including Unit tests etc.)UNIT-I-Introduction and value of mushrooms .

Course Details:

Unit	Learning Units	Lecture Hours
I	<p>Mushrooms: Definition, structure of a mushroom and a brief account of life cycle; historical account and scope of mushroom cultivation; difference between edible and poisonous mushrooms.</p> <p>Morphological features of any four edible mushrooms, Button mushroom (<i>Agaricusbisporus</i>), Milky mushroom (<i>Calocybe indica</i>), Oyster mushroom (<i>Pleurotussajor-caju</i>) and Paddy straw mushroom (<i>Volvariellavohvacea</i>). Nutritional value of mushrooms; medicinal mushrooms in South India - Ganoderma lucidum, Phellinus rimosus, Pleurotus florida and Pleurotus pulmonaris – their therapeutic value; Poisonous mushrooms - harmful effects.</p>	10
II	<p>Basic requirements of cultivation system</p> <p>Small village unit and larger commercial unit; layout of a mushroom farm - location of building plot, design of farm, bulk chamber, composting, equipment and facilities, pasteurization room and growing rooms.</p> <p>Compost and composting: Definition, machinery required for compost making, materials for compost preparation.</p> <p>Methods of composting- long method of composting and short method of composting</p>	10
III	<p>Spawning and casing</p> <p>Spawn and spawning: Definition, facilities required for spawn preparation; preparation of spawn substrate. Preparation of pure culture, media used in raising pure culture; culture maintenance, storage of spawn.</p> <p>Casing: Definition, Importance of casing mixture, Quality parameters of casing soil, different types of casing mixtures, commonly used materials.</p>	10
IV	<p>Mushroom cultivation</p> <p>Raw material, compost, spawning, casing, cropping, and problems in cultivation (diseases, pests and nematodes, weed molds and their management strategies), picking and packing for any Four of the following mushrooms: (a) Button mushroom (b) Oyster mushroom (c) Milky mushroom and (d) Paddy straw mushroom</p>	10
V	<p>Post harvest technology</p> <p>Shelf life of mushrooms; preservation of mushrooms - freezing, dry freezing, drying and canning. Quality assurance and entrepreneurship - economics of different types of mushrooms; value added products of mushrooms.</p> <p>Management of spent substrates and waste disposal of various mushrooms.</p>	10

References/TextBook/ e-books/websites

1. ~~Tewari Pankaj Kapoor, S. C. (1988). Mushroom Cultivation. Mittal Publication, New Delhi.~~
2. Pandey R.K, S. K Ghosh, (1996). A Hand Book on Mushroom Cultivation. Emkey Publications
3. Web resources suggested by the teacher concerned and the college librarian including reading material.

Reference Materials on the Web/web links:

<https://www.youtube.com/watch?v=DwMCw14khIU>

<https://www.youtube.com/watch?v=vggMIUelsoU>

IV Co-Curricular Activities

(a) Mandatory: (Training of students by teacher in field related skills: (lab: 10 + field: 05)

1. **For Teacher:** Training of students by teacher in the laboratory/field for not less than 15 hours on the field techniques/skills of identification of edible and poisonous mushrooms, basic facilities of a mushroom culture unit, preparation of compost and spawn, cultivation practices of edible mushrooms, storage and marketing of produce.

2. **For Student:** Students shall (individually) visit mushroom culture units in universities/research organizations/private sector write their observations on infrastructure, cultivation practices and products of a mushroom culture unit etc., and submit to the teacher a hand-written Fieldwork/Project work Report not exceeding 10 pages in the given format.

3. Max marks for Fieldwork/Project work Report: 05.

6. Suggested Format for Fieldwork/Project work Report: Title page, student details, index page, details of place visited, observations, findings and acknowledgements.

4. Unit tests (IE).

b) Suggested Co-Curricular Activities: 1. Training of students by related industrial experts.

2. Assignments (including technical assignments like identifying various mushrooms, tools and techniques for culture, identification and control of diseases etc.,

3. Seminars, Group discussions, Quiz, Debates etc. (on related topics).

4. Preparation of videos on tools and techniques in mushroom culture.

5. Collection of material/figures/photos related to edible and poisonous mushrooms, cultivation of mushrooms in cottage industries, writing and organizing them in a systematic way in a file.

6. Visits to mushroom culture units in universities, research organizations, private firms, etc.

7. Invited lectures and presentations on related topics by field/industrial experts.

(An Autonomous college in the jurisdiction of Krishna University)

TITLE OF THE PAPER: Mushroom Cultivation

Model Question Paper Structure for SEE

Max. Time: 3 Hrs.

Course Code: BOT-502

Max. Marks: 70M

SECTION – B

Answer any FOUR of the following questions.

4x5=20 Marks

(Draw diagrams wherever necessary)

1. Extend the medicinal value of *Ganoderma*.
2. Describe the small village unit.
3. List the facilities required for spawn preparation.
4. Explain weed mold in mushroom cultivation.
5. Illustrate the Novel Value Added Products of Mushrooms.
6. Enumerate the Poisonous mushrooms.
7. Summarize Layout of a mushroom farm.
8. Explain about the Casing oil.

SECTION – B

5x10 =50M

Answer all questions.

(Draw diagrams wherever necessary)

9. Describe the life cycle of a mushroom.
10. Describe the morphological features of Paddy straw and oyster mushroom.
11. Explain various types of composting methods.
12. Point out basic requirements of mushroom cultivation.
13. What is casing? Explain different types of casing mixture and their Importance.
14. Summarize the process of cultivation of Milky mushroom.
15. Extend an account cultivation of Oyster mushroom.
16. What are the conditions required to improve shelf life of mushrooms?

Guide lines for paper setter: (for Paper V-BOT-502) W.e.f. 2022-23

6. In Section A: Unit I, II, III, must carry Two questions from each unit. Unit I, II & V must carry one question.

7. In section-B: Set minimum two questions from Unit I, II & IV and Set One Question from III & V.

8. See the following table and Model paper.

9. Please provide the scheme of valuation for the paper.

10. Question paper should be both in English and Telugu media.

Unit	Section – A		Section - B		Weightage in
	Questions	Marks	Questions	Marks	Marks
Unit – I	2		2		30
	10		20		
Unit – II	2		2		30
	10		20		
Unit – III	2		1		20
	10		10		
Unit-IV	1		2		25
	5		20		
Unit-V	1		1		15
	5		10		
Max. Q & marks	8 (x 5) = 40		8 (x 10) = 80		(Total questions = 16) Marks 120
Max. Q and marks for Valuation	Questions	Marks	Questions	Marks	Max. marks
	4		5		70
	(4 x 5) = 20		(5 x 10) = 50		

INTERNAL EXAMS – 30 Marks

(20 marks for unit tests, 5 marks for assignments and remaining 5 marks for seminar etc.)

A .G & S .G. SIDDHARTHA DEGREE COLLEGE OF ARTS AND SCIENCE, VUYYURU
(An Autonomous college in the jurisdiction of Krishna University)

Practical Syllabus

SEMESTER- V (7C)

PAPER- V

CREDITS: 02

BOTANY	SECBOT502	WEF: 2022-2023	B. Sc (BZC), AQUA
---------------	------------------	-----------------------	--------------------------

MUSHROOM CULTIVATION

Type of the Course: Skill Enhancement Course (Elective: Practical),

I. Course Outcomes: Students at the successful completion of the course will be able to:

- CO1: Identify different types of mushroom.
- CO2: Demonstrate preparation of pure culture of an edible mushroom.
- CO3: Prepare compost and casing mixture.
- CO4: Crop and harvest mushrooms.
- CO5: Prepare value-added products.

II: Practical (Laboratory) Syllabus :(30Periods):Atleast8Practicals....

1. Identification of different types of mushrooms.
2. Preparation of pure culture of an edible mushroom.
3. Preparation of mother spawn.
4. Production of planting spawn and storage.
5. Preparation of compost and casing mixture.
6. Demonstration of spawning and casing.
7. Hands on experience on cropping and harvesting.
8. Demonstration of storage methods.
9. Preparation of value-added products.

III. Lab References:

1. Sushma Sharma Sapna Thakur Ajar NathYadav, 2018. Mushroom Cultivation: A Laboratory Manual, Eternal University, Sirmour, H.P.
2. Kadhila -Muandingi, N.P., F. S. Mubiana and K. L. Halueendo, 2012. Mushroom Cultivation: A Beginners Guide, The University of Namibia
3. Gajendra Jagatap and UtpalDey, 2012. Mushroom Cultivation:Practical Manual, LAMBERT Academic Publishing, Saarbrücken, Germany
4. Deepak Som, 2021. A Practical Manual on Mushroom Cultivation, P.K.Publishers& Distributors, Delhi
5. Web sources suggested by the teacher concerned.

Question Paper Pattern: Practicals

Time: 3 hrs

Max.Marks:50

-
1. Demonstration of preparing pure culture/mother spawn 'A' 5 M
 2. Preparation method for planting spawn and storage/compost and casing material 'B' 5 M
 3. Demonstration of spawning and casing/storage and making a value- added product 'C' 5 M

4. Scientific observation and data analysis 4 x 2 = 08M

- D. Edible/poisonous mushroom specimen/photograph
 - E. Infrastructure/tool used in mushroom cultivation
 - F. Material for compost/casing
 - G. Storage practice/ a value-added product
5. Viva Voce 2M

Internals:

1. Record .05M
2. Project work..... 10M
3. Field trip .5M
4. Internal practical exam 05M

Total Marks: 25

**A.G& S.G.SIDDHARTHA DEGREE COLLEGE OF ARTS &
SCIENCE**

VUYYURU-521165, KRISHNA Dt., A.P.(Autonomous)

Accredited by NAAC with "A" Grade

2022-2023



DEPARTMENT OF CHEMISTRY

MINUTES OF BOARD OF STUDIES

ODD SEMESTER

27-10-2022

Minutes of the Meeting of Board of Studies in Chemistry for the Autonomous Course
A.G. & S.G. Siddhartha Degree College of Arts & Science, Vuyyuru held at 11.00 A.M
on 27-10-2022 in the Department of Chemistry

Sri. K.RAMESH

Presiding

Members Present:

- 1) *K. Ramesh* Chairman HOD, Dept. of Chemistry,
(Sri. K.RAMESH) A.G. & S.G.S.Degree College, Vuyyuru.
- 2) University Nominee Assistant Professor,
(Prof.D.Ramasekhar Reddy) Dept. of Chemistry, Krishna University, MTM.
- 3) Academic Council Nominee HOD, Dept. of Chemistry,
(Dr. S. Kalpana) SDMS M College, Vijayawada.
- 4) Academic Council Nominee Lecturer in Chemistry,
(Smt. A. Indira) G.D.C, Dumpagadapa.
- 5) Industrialist Manager, Q.A, Biophore india
(Dr. G Raja) Pharmaceuticals pvt ltd Hyd.
- 6) Student Nominee Lecturer in Chemistry,
(Smt. M. Sowjanya) ANR College Gudivada.
- 7) *G. Giri Prasad* Member Lecturer in Chemistry,
(Dr. G.Giri prasad) A.G.S.G.S.Degree College, Vuyyuru
- 8) *M. V. Santhi* Member Lecturer in Chemistry,
(Smt. M.V.Sanathi) A.G. & S.G.S.Degree College, Vuyyuru.
- 9) *P. Suresh* Member Lecturer in Chemistry,
(Sri. P.Suresh) A.G.& S.G.S.Degree College, Vuyyuru.
- 10) *M. Santhi* Member Lecturer in Chemistry,
(MS M.Sanathi) A.G.& S.G.S.Degree College, Vuyyuru.
- 11) *J. Nageswara Rao* Member Rtd.Lecturer in Chemistry,
(Sri. J.Nageswara Rao) A.G.& S.G.S.Degree College, Vuyyuru.

Agenda for B.O.S Meeting

1. To recommend the syllabus and model paper for I semester of I Degree B.Sc., Chemistry for the Academic year 2022-2023.
2. To recommend the syllabus and model papers for III semester of II Degree B.Sc., Chemistry for the Academic year 2022-2023.
3. To recommend the syllabus and model papers for V semester of III Degree B.Sc. Chemistry for the Academic year 2022-2023.
4. To recommend the Blue print of I,III,V semesters of B.Sc. Chemistry for the Academic year 2022--2023.
5. To recommend the Guidelines to be followed by the question paper setters in Chemistry for I,III,V Semester – end exams.
6. To recommend the teaching and evaluation methods to be followed under Autonomous status.
7. Any suggestions regarding certificate course, seminars, workshops, Guest lecture to be organized.
8. Recommend the panel of paper setters and Examiners to the controller of Examinations of
9. Any other matter.

K. Ramell
Chairman

RESOLUTIONS

1. It is resolved to follow the same syllabus (**theory and practical**) for I semesters of IB.Sc. under Choice Based Credit System (CBCS) for the Academic year 2022--2023.
2. It is resolved to follow the same syllabus (**theory and practical**) for III semesters of II B.Sc. under Choice Based Credit System (CBCS) for the Academic year 2022--2023.
3. It is resolved to follow the new syllabus (**theory and practical**) for V semesters of III B.Sc. under Choice Based Credit System (CBCS) for the Academic year 2022--2023.
Paers introduced: Analytical methods in Chemistry-I with course code SEC CHE 501C/601C and Analytical methods in Chemistry-II with course code SEC CHE 502C/602C
4. It is resolved to follow the **Blue prints** as proposed by members of BOS I, III & V semester of Degree B.Sc. for the Academic year 2022-2023.
5. It is resolved to follow the **guidelines** to be followed by the question paper setters of Chemistry for I, III & V semesters of Degree B.Sc. for the Academic Year 2022-2023.
6. **SDC in Food Adulteration is introduced with course code SDCCHETO1 for III Semester.**
7. It is resolved to continue the following teaching and evaluation methods for Academic year 2022-23.

Teaching Methods:

Besides the conventional methods of teaching, we use modern technology i.e. using of LCD projector to display on U boards etc, for better understanding of concepts.

Evaluation of a student is done by the following procedure:

Internal Assessment Examinations:

Out of maximum 100 marks in each paper for I B.Sc, 30 marks shall be allocated for internal assessment. Out of these 30 marks, 20 marks are allocated for announced tests (i.e. IA-1 & IA-2).

Out of maximum 100 marks in each paper for II B.Sc, 25 marks shall be allocated for internal assessment. Out of these 25 marks, 15 marks are allocated for announced tests (i.e. IA-1 & IA-2).

Out of maximum 100 marks in each paper for III B.Sc, 30 marks shall be allocated for internal assessment. Out of these 30 marks, 20 marks are allocated for announced tests (i.e. IA-1 & IA-2).

Two announced tests will be conducted and average of these two tests shall be deemed as the marks obtained by the student, 5 marks are allocated on the basis of candidate's percentage of attendance and remaining 5 marks are allocated for the innovative component like assignment/quiz/seminars for I, II, III B.Sc.

There is no pass minimum for internal assessment for I, II, III B.Sc.

Semester – End Examination:

The maximum marks for I, III, V B.Sc Semester – End examination shall be 70/75/70 marks duration of the examination shall be 3 hours. Even though the candidate is absent for two IA exams /obtain Zero marks the external marks are considered (if the candidate gets 40/70/75) and the result shall be declared as "PASS".

Semester – End examinations shall be conducted in theory papers at the end of every semester, while in practical papers, these examinations are conducted at the end of I, III & V semesters for I, II & III B.Sc for 50 marks.

Discussed and recommended for organizing certificate course, seminars, Guest lecturers, workshops to upgrade the knowledge of students, for the approval of the academic council.

Discussed and empowered the Head of the department of Chemistry to suggest the panel of paper setters and examiners to the controller of examinations

1. NIL.

Chairman



A.G & S.G. SIDDHARTHA DEGREE COLLEGE OF

ARTS & SCIENCE

Vuyyuru-521165

NAAC reaccredited at "A" level

Autonomous -ISO 9001 – 2015 Certified

Title of the Paper: Inorganic & Physical Chemistry

Semester: I (60 Hr)

Course Code	CHET11A	Course Delivery Method	Class Room / Blended Mode
Credits	3	CIA Marks	30
No. of Lecture Hours / Week	4	Semester End Exam Marks	70
Total Number of Lecture Hours	60	Total Marks	100
Year of Introduction : 2021 - 22	Year of Offering: 2022 - 23	Year of Revision: -----	Percentage of Revision: 0

Course outcomes:

- At the end of the course, the student will be able to;
- **CO1.** Understand the basic concepts of p-block elements.
- **CO2.** To compare the periodic properties of d and f block elements and explain the bonding and structures of metal carbonyls.
- **CO3.** To understand the properties and structure of Solid state.
- **CO4.** To understand the properties of gaseous and liquid states.
- **CO5.** To explain the properties of Solutions.

Learning Objectives:

- To understand the preparation and structure of complex compounds.
- To explain the properties and structure of d and f block elements and understand the theories of bonding in metals
- To understand the symmetry in crystals and properties and structure of Solid state.
- To understand the properties and structure of gaseous and liquid states.
- To understand the properties of solutions.

Syllabus

Course Details

Unit	Learning Units	Lecture Hours
INORGANIC CHEMISTRY		24h
I	<p>Chemistry of p-block elements 8h</p> <p>Group 13: Preparation & structure of Diborane, Borazine Group 14: Preparation, classification and uses of silicones Group 15: Preparation & structures of Phosphonitrilic halides { (PNCl₂)_n where n=3, 4 Group 16: Oxides and Oxoacids of Sulphur (structures only) Group 17: Pseudohalogens, Structures of Interhalogen compounds.</p>	8h
	<p>d-block elements 6h</p> <p>Characteristics of d-block elements with special reference to electronic configuration, variable valence, magnetic properties, catalytic properties and ability to form complexes. Stability of various oxidation states.</p>	6h
II	<p>f-block elements 6h</p> <p>Chemistry of lanthanides - electronic structure, oxidation states, lanthanide contraction, consequences of lanthanide contraction, Magnetic properties. Chemistry of actinides - electronic configuration, oxidation states, actinide contraction, comparison of lanthanides and actinides.</p>	6h
	<p>Metals 4h</p> <p>Valence bond theory and free electron theory, explanation of thermal and electrical conductivity of metals based on these theories, Band theory- formation of bands, Explanations of conductors, semiconductors and insulators.</p>	4h
Physical Chemistry		36h
III	<p>Solid State</p> <p>Symmetry in crystals. Law of constancy of interfacial angles. The law of rationality of indices. The law of symmetry. Miller indices, Definition of lattice point, space lattice, unit cell. Bravais lattices and crystal systems. X-ray diffraction and crystal structure. Bragg's law. Powder method. Defects in crystals.</p>	10h

	3.5 Stoichiometric and non-stoichiometric defects.	
IV	Gaseous state van der Waal's equation of state. Andrew's isotherms of carbon dioxide, continuity of state. Critical phenomena. Relationship between critical constants and van der Waal's constants. Law of corresponding states. Joule- Thomson effect. Inversion temperature.	6h
	Liquid state Liquid crystals, mesomorphic state. Differences between liquid crystal and solid/liquid. Classification of liquid crystals into Smectic and Nematic. Application of liquid crystals as LCD devices.	4h
V	Solutions, Ionic equilibrium & dilute solutions Solutions Azeotropes-HCl-H ₂ O system and ethanol-water system. Partially miscible liquids-phenol- water system. Critical solution temperature (CST), Effect of impurity on consolute temperature. Immiscible liquids and steam distillation. Nernst distribution law. Calculation of the partition coefficient. Applications of distribution law.	6h
	Ionic equilibrium Ionic product, common ion effect, solubility and solubility product. Calculations based on solubility product.	3h
	Dilute solutions Colligative properties- RLVP, Osmotic pressure, Elevation in boiling point and depression in freezing point. Experimental methods for the determination of molar mass of a non-volatile solute using osmotic pressure, Elevation in boiling point and depression in freezing point. Abnormal colligative properties. Van't Hoff factor.	7h

Co-curricular activities and Assessment Methods

1. Continuous Evaluation: Monitoring the progress of student's learning
2. Class Tests, Worksheets and Quizzes
3. Presentations, Projects and Assignments and Group Discussions: Enhances critical thinking skills and personality
4. Semester- end Examination: critical indicator of student's learning and teaching methods adopted by teachers throughout the semester.

List of Reference Books

1. Principles of physical chemistry by Prutton and Marron
2. Solid State Chemistry and its applications by Anthony R. West
3. Text book of physical chemistry by K L Kapoor
4. Text book of physical chemistry by S Glasstone
5. Advanced physical chemistry by Bahl and Tuli
6. Inorganic Chemistry by J.E.Huheey
7. Basic Inorganic Chemistry by Cotton and Wilkinson
8. A textbook of qualitative inorganic analysis by A.I. Vogel
9.

Atkins, P.W. & Paula, J. de Atkin's Physical Chemistry Ed.,
Oxford University Press 10th Ed (2014).
10. Castellan, G. W. Physical Chemistry 4th Ed. Narosa (2004).
11. Mortimer, R. G. Physical Chemistry 3rd Ed. Elsevier: NOIDA, UP (2009).
12. Barrow, G. M. Physical Chemistry

WEB Links:

<https://ncert.nic.in/ncerts/l/kech204.pdf>

<https://www.askiitians.com/iit-jee-chemistry/general-properties-of-the-transition-elements-d-block/>

<https://www.nptel.ac.in/courses/104/104/104104101/>

<https://physicscatalyst.com/chemistry/vander-waals-equations.php>

**A.G. & S.G.SIDDHARTHA DEGREE COLLEGE OF ARTS & SCIENCE
(AUTONOMOUS), VUYYURU.
(Accredited at "A" Grade by NAAC, Bangalore)**

MODEL PAPER

FIRST YEAR B.Sc., DEGREE EXAMINATION

SEMESTER-I

CHEMISTRY Course-I: INORGANIC & PHYSICAL CHEMISTRY

Time: 3 hours

Maximum Marks: 75

PART- A

5 X 5 = 25 Marks

Answer any **FIVE** of the following questions. Each carries **FIVE** marks

1. Explain the preparation & structures of Phosphonitrilic compounds. **L1**
2. Explain in brief, catalytic properties & stability of various oxidation states of d- block elements. **-L1**
3. Write short note on Bravais lattices and crystal systems. **-L2**
4. What are Smectic & Nematic liquid Crystals? Explain. **-L1**
5. Write account on Common ion effect & Solubility product. **-L1**
6. Describe Andrew's isotherms of carbon dioxide. **-L2**
7. Explain Actinide Contraction. **-L2**
8. Explain the structure of Borazine. **-L2**

PART- B

5 X 10 = 50 Marks

Answer **ALL** the questions. Each carries **TEN** marks

9

- (a). Explain Classification, Preparations & uses of Silicones **-L1**
(or)

- (b). (i) What are Pseudohalogens. **-L1**
(ii) Explain the Structures of any one AX₃ & AX₅ interhalogen compounds. **-L1**

- 10** (a). What is Lanthanide Contraction? Explain the Consequences of Lanthanide Contraction. **-L1**
(or)

- (b). (i) Explain the magnetic properties of d- block elements.

(ii) Explain about Conductors, Semi-Conductors & Insulators using Band Theory. **-L1**

11.(a). Write an essay on Crystal defects. **-L2**

(or)

(b). What is Bragg's Law. Explain the determination of structure of a crystal by powder method. **-L2**

12.(a). Derive the relationship between Critical constants & Vanderwaal constants **-L2**

(or)

(b).(i) Write any 5 differences between liquid crystals & liquids, solids

(ii) Write the applications of Liquid crystals. **-L2**

13.(a). Explain Nernst distribution Law. Explain its applications **-L2**

(or)

(b). What are colligative properties. Write experimental methods for determination of molar mass of a non-volatile solute by using Elevation in boiling point & depression in freezing point. –

**A.G. & S.G.SIDDHARTHA DEGREE
COLLEGE OF ARTS & SCIENCE
(AUTONOMOUS), VUYYURU.
(Accredited at “A” Grade by NAAC, Bangalore)**

**MODEL PAPER
FIRST YEAR B.Sc., DEGREE EXAMINATION
SEMESTER-I**

CHEMISTRY Course-I: INORGANIC & PHYSICAL CHEMISTRY

Time: 3 hours

Maximum Marks: 70

Answer all questions

1. (a) -10M L1
(b) – 4M L2
(or)
(c) -10M L1
(d) – 4M L2
2. (a) -10M L3
(b) – 4M L2
(or)
(c) -10M L2
(d) – 4M L3
3. (a) -10M L1
(b) – 4M L2
(or)
(c) -10M L1
(d) – 4M L2
4. (a) -10M L3
(b) – 4M L1
(or)
(c) -10M L1
(d) – 4M L3
5. (a) -10M L2
(b) – 4M L2
(or)
(c) -10M L2
(d) – 4M L2

**A.G. & S.G.SIDDHARTHA DEGREE COLLEGE OF ARTS & SCIENCE
(AUTONOMOUS), VUYYURU.
(Accredited at “A” Grade by NAAC, Bangalore)**

MODEL PAPER

FIRST YEAR B.Sc., DEGREE EXAMINATION

SEMESTER-I

CHEMISTRY Course-I: INORGANIC & PHYSICAL CHEMISTRY

Time: 3 hours

Maximum Marks: 70

Section-A

Answer all questions .Each question carries 4 marks 5 X 4 =20M

1. 4M
(OR)
4M
2. 4M
(OR)
4M
3. 4M
(OR)
4M
4. 4M
(OR)
4M
5. 4M
(OR)
4M

Section-B

Answer all questions .Each question carries 10 marks5 X 10 =50M

6. 10M
(OR)
10M
7. 10M
(OR)
10M
8. 10M
(OR)
10M
9. 10M
(OR)
10M
10. 10M
(OR)
10M

**A.G. & S.G.SIDDHARTHA DEGREE COLLEGE OF ARTS & SCIENCE
(AUTONOMOUS), VUYYURU.**

(Accredited at “A” Grade by NAAC, Bangalore)

LABORATORY COURSE –I

Practical-I ANALYSIS OF SALT MIXTURE (At the end of Semester-I)
(Minimum of Six mixtures should be analyzed)

Credits:2

30 hrs (2 h / w)

10M+40M =50M

Course outcomes:

At the end of the course, the student will be able to;

2. Understand the basic concepts of qualitative analysis of inorganic mixture
3. Use glassware, equipment and chemicals and follow experimental procedures in the laboratory
4. Apply the concepts of common ion effect, solubility product and concepts related to qualitative analysis

Analysis of Salt Mixture

Analysis of mixture salt containing two anions and two cations (From two different groups) from the following:

Anions: Carbonate, Sulphate, Chloride, Bromide, Acetate, Nitrate, Borate, Phosphate.

Cations: Lead, Copper, Iron, Aluminium, Zinc, Nickel, Manganese, Calcium, Strontium, Barium, Potassium and Ammonium.

Co-curricular activities:

1. To attain skill in semi-micro inorganic qualitative analysis students are made to analyze the same on chemicals used in everyday life.

Reference Books :

1. Dr. V.V. Ramanujan inorganic semi micro qualitative analysis, The National publishing company.
2. Vogel's text book of qualitative inorganic analysis, addition Wesley longman 7th edition 2001.



A.G & S.G. SIDDHARTHA DEGREE COLLEGE OF

ARTS & SCIENCE

Vuyyuru-521165

NAAC reaccredited at "A" level

Autonomous -ISO 9001 – 2015 Certified

Title of the Paper: ORGANIC CHEMISTRY & SPECTROSCOPY

Semester: III (60 Hr)

Course Code	CHET31A	Course Delivery Method	Class Room / Blended Mode
Credits	3	CIA Marks	25
No. of Lecture Hours / Week	4	Semester End Exam Marks	75
Total Number of Lecture Hours	60	Total Marks	100
Year of Introduction : 2021 - 22	Year of Offering: 2022 - 23	Year of Revision: -----	Percentage of Revision:

Course out comes:

Topics will include structure, stereochemistry, nomenclature, synthesis, properties, and reactions of the major classes of organic compounds. A mechanistic approach is used in the course to explain the reactions of these compounds.

Spectroscopy is general term used for the instrumental process by which information about molecular structure is obtained through careful analysis of absorption, scattering or emission of electromagnetic radiation by compounds.

Learning Objectives:

1. Student will know the preparation, properties and reactions of halo alkanes, halo arenes and oxygen containing functional groups

2. Student Use the synthetic chemistry learnt in this course to do functional group transformations.
3. Will know the different types of carboxylic acids their preparations & properties
4. Knowing various applications of spectroscopy methods
5. Learn to apply spectroscopy to simple organic compounds

Course Outcomes:

At the end of this course, students should be able to:

CO1: Remember the preparations, properties and reactions of halo alkanes, halo arenes and oxygen containing functional groups.-**PO1**

CO2: Understand preparation, properties and reactions of carbonyl compounds -**PO1**

CO3: Apply preparation methods for carboxylic acids and their derivatives-**PO1**

CO4: Analyze various molecules and polyatomic molecules using different spectroscopy methods-**PO1, PO7**

CO5: Evaluate the functional groups of different organic compounds- **PO1, PO7**

CO6: Create applications of spectroscopy for various organic molecules- **PO1, PO7**

Syllabus

Course Details

Unit	Learning Units	Lecture Hours
I	<p>Chemistry of Halogenated Hydrocarbons</p> <p>Alkyl halides: Methods of preparation and properties, nucleophilic substitution reactions– SN¹, SN² and SNⁱ mechanisms with stereo chemical aspects and effect of solvent etc.; nucleophilic substitution vs. elimination, Williamson’s synthesis. Arylhalides: Preparation (including preparation from diazonium salts) and properties, nucleophilic aromatic substitution; S_NAr, Benzyne mechanism. Relative reactivity of alkyl, allyl, benzyl, vinyl and aryl halides towards nucleophilic substitution reactions.</p> <p>Alcohols & Phenols</p> <p>Alcohols: preparation, properties and relative reactivity of 1°, 2°, 3° alcohols, Bouvaelt Blanc Reduction; Oxidation of diols by periodic acid and lead tetra acetate, Pinacol- Pinacolone rearrangement; Lucas Reagent</p> <p>Phenols: Preparation and properties; Acidity and factors effecting it, Ring substitution reactions, Reimer–Tiemann and Kolbe’s–Schmidt Reactions, Fries and Claisen rearrangements with mechanism;</p>	12 Hrs
II	<p>Carbonyl Compounds</p> <p>Structure, reactivity, preparation and properties; Nucleophilic additions, with NaHSO₃, Formation of alcohols, HCN, Grignard’s Reagent(Rmgx), hemiacetol’s, Fehling’s, Tollen’s, 2,4-Di Nitro Phenyl hydrazine (2,4-DNPH) and formation of oximes Nucleophilic addition-elimination reactions with ammonia derivatives Mechanisms of Aldol and Benzoin condensation, Claisen-Schmidt, Perkin, Cannizzaro and Wittig reaction, Beckmann halo form reaction and Baeyer Villiger oxidation, α-substitution reactions, oxidations and reductions (Clemmensen, Wolf – kishner, with LiAlH₄ & NaBH₄). Addition reactions of α,β-unsaturated carbonyl compounds: Michael addition.</p> <p>Active methylene compounds: Keto- Enol tautomerism. Preparation and synthetic applications of diethyl malonate and ethyl aceto acetate.</p>	10 hrs
	Carboxylic Acids and their Derivatives	

III	<p>General methods of preparation, physical properties and reactions of mono carboxylic acids, effect of Substituents on acidic strength. Typical reactions of dicarboxylic acids, hydroxyl acids and unsaturated acids. Preparation and reactions of acid chlorides, anhydrides, esters and amides; Comparative study of nucleophilic substitution at acyl group-Mechanism of acidic and alkaline hydrolysis of esters, Claisen condensation, Reform at sky reactions and Curtius rearrangement Reactions involving H, OH and COOH groups-salt formation, anhydride formation, acid chloride formation, amide formation and esterification (mechanism). Degradation of carboxylic acids by Huns-Diecker reaction, de carboxylation by Schimdt reaction, Arndt-Eistert synthesis, halogenation by Hell- Volhard- Zelinsky reaction.</p>	12 hrs
IV	<p>Molecular Spectroscopy: Interaction of electromagnetic radiation with molecules and various types of spectra;</p> <p>Rotation spectroscopy: Selection rules, intensities of spectral lines, determination of bond lengths of diatomic and linear triatomic molecules, isotopic substitution.</p> <p>Vibrational spectroscopy: Classical equation of vibration, computation of force constant, Harmonic and an harmonic oscillator, Morse potential curve,vibrational degrees of freedom molecules, modes of vibration. Selection rules for vibrational transitions, Fundamental frequencies, overtones and hot bands.</p> <p>Electronic spectroscopy: Energy levels of molecular orbitals (σ, π, n). Selection rules for electronic spectra. Types of electronic transitions in molecules, effect of conjugation. Concept of chromophore. Bathochromic and hypsochromic shifts.Beer-Lambert's law and its limitations.</p> <p>Nuclear Magnetic Resonance (NMR) spectroscopy: Principles of nuclear magnetic resonance, equivalent and non-equivalent protons, position of signals. Chemical shift, NMR splitting of signals - spin-spin coupling, coupling constants. Applications of NMR with suitable examples - ethyl bromide, ethanol, acetaldehyde, 1,1,2-tribromo ethane, ethyl acetate, toluene and acetophenone.</p>	18 hrs
	<p>Application of Spectroscopy to Simple Organic Molecules Application of visible, ultraviolet and Infrared</p>	

V	<p>spectroscopy in organic molecules.</p> <p>Application of electronic spectroscopy and Woodward rules for calculating λ_{max} of conjugated dienes and α, β – unsaturated compounds.</p> <p>Infrared radiation and types of molecular vibrations, functional group and fingerprint region. IR spectra of alkanes, alkenes and simple alcohols (inter and intramolecular hydrogen bonding), aldehydes, ketones, carboxylic acids and their derivatives (effect of substitution on $>C=O$ stretching absorptions).</p>	8 hrs
---	--	-------

Textbook:

1. B.S.Bhal, Arun Bhal Advanced Organic Chemistry, Ramnagar, New Delhi 2001
2. P K Bruice. Organic Chemistry by Bruice, Pearson Education, Patparganj, Delhi-2001
3. Jonathan Clyden, Nick Greaves, Organic Chemistry by Clyden, Oxford University press
4. William Kempf, Spectroscopy by William Kemp, Palgrave, USA-3rd edition
5. Y R Sharma, Elementary Organic Spectroscopy, S Chand, 4th revised edition.

Recommended Reference book:

1. Mann, F.G. & Saunders, B.C. Practical Organic Chemistry, Pearson Education (2009)
2. Furniss, B.S., Hannaford, A.J., Smith, P.W.G. & Tatchell, A.R. Practical Organic Chemistry, 5th Ed. Pearson (2012)
3. Ahluwalia, V.K. & Aggarwal, R. Comprehensive Practical Organic Chemistry: Preparation and Quantitative Analysis, University Press (2000).

Course Delivery method: Face-to-face / Blended

Course has focus on:
Employability / Entrepreneurship

Websites of Interest:

1. <https://www.sydney.edu.au/science/chemistry/~george/halides.html>
- 2.

[https://chem.libretexts.org/Bookshelves/Organic_Chemistry/Organic_Chemistry_\(McMurry\)/17%3A_Alcohols_and_Phenols/17.00%3A_Introduction](https://chem.libretexts.org/Bookshelves/Organic_Chemistry/Organic_Chemistry_(McMurry)/17%3A_Alcohols_and_Phenols/17.00%3A_Introduction)

3.

<https://nptel.ac.in/content/storage2/courses/104101005/downloads/LectureNotes/chapter%2010.pdf>

4. <https://www.khanacademy.org/science/organic-chemistry/carboxylic-acids-derivatives/formation-carboxylic-acid-derivatives-sal/v/fisher-esterification?modal=1>
5. <https://byjus.com/chemistry/infrared-spectroscopy/>
6. <https://www.lehigh.edu/~kjs0/carey-13.PDF>

Co-curricular Activities:

Continuous Evaluation: Monitoring the progress of student's learning Class Tests Work sheets and Quizzes Presentations, Assignments and Group Discussions.

**A.G. & S.G.SIDDHARTHA DEGREE COLLEGE OF ARTS & SCIENCE
(AUTONOMOUS), VUYYURU.
(Accredited at "A" Grade by NAAC, Bangalore)
SEMESTER-III
CHEMISTRY COURSE-III: ORGANIC CHEMISTRY &
SPECTROSCOPY**

Time: 3 hours

Maximum Marks: 75

PART- A

5 X 5 = 25 Marks

Answer any **FIVE** of the following questions. Each carries **FIVE** marks

1. Tell any two methods for preparation of aryl halides- **L1-CO1**
2. Summarize the mechanism for Pinacol-Pinacolone rearrangement-**L2-CO2**
3. Interpret the mechanism for Bayer-villiger oxidation reaction.-**L2-CO2**
4. Explain the effect of substituents on acidic strength of mono-carboxylic acids.-**L1-CO3**
5. Interpret the mechanism for Claisen Condensation reaction. **L2-CO3**
6. Tell the selection rules in rotational spectroscopy.-**L1-CO4**
7. Explain Spin – Spin coupling and Coupling Constant.-**L1-CO4**
8. Classify types of electronic transitions in UV spectroscopy.**L2- CO4**

PART- B

5 X 10 = 50 Marks

Answer **ALL** the questions. Each carries **TEN** marks

9 (a). Explain the mechanism & stereochemistry of SN1& SN2 reactions of alkyl halides with suitable example.**L1-CO1**

(or)

(b). Explain the following reactions with mechanism. **L1-CO1**

(i) Reimer-Tiemann reaction (ii) Fries rearrangement.

10 (a). Interpret the mechanism for following reactions.**L2-CO2**

(i) Perkin reaction. (ii) Cannizaro reaction

(or)

(b). Summarize the preparation and any three synthetic applications of diethyl malonate. **L2-CO2**

11. (a). Explain acid and base hydrolysis reaction of esters with mechanism. **L1-CO3**

(or)

(b). Explain the mechanisms of Curtius rearrangement & Arndt –Eistert reaction. **L1-CO3**

12. (a). (i) Tell a note on vibrational degrees of freedom for polyatomic molecules. **L1-CO4**

(ii) Explain different modes of vibrations & selection rules in IR spectroscopy.

(or)

(b). (i) Define Bathochromic shift. Explain the effect of conjugation in U.V. spectroscopy. **L1-CO4**

(ii) Describe the principle of NMR spectroscopy.

13. (a). Relate Woodward-Fieser rules for calculating λ_{\max} for conjugated dienes and α, β – unsaturated carbonyl compounds, and apply them for one example each. **L2-CO5**

(or)

(b). (i) Summarize Fingerprint region and its significance with an example. (ii) Write IR spectral data for any one alcohol, aldehyde and ketone – **L2-CO5**

**A.G. & S.G.SIDDHARTHA DEGREE COLLEGE OF ARTS & SCIENCE
(AUTONOMOUS), VUYYURU.**

(Accredited at “A” Grade by NAAC, Bangalore)

Title of the Paper

(ORGANIC PREPARATIONS AND IR SPECTRAL ANALYSIS)

Laboratory Course-III

Semester: III

Credits: 1

Hours Taught: 30 hrs. (2hr/W)

Max.Time : 2 Hours

Course Prerequisites (if any): Basics of Organic Preparations and IR Spectroscopy

Course Description: Preparation of different organic compounds using conventional, Green approach methods and IR spectral analysis for different functional groups

Course Objectives:

1. Student will know the safe laboratory practices by handling laboratory glassware, equipment, and chemical reagents appropriately.
2. Dispose of chemicals in a safe and responsible manner
3. Create and carry out work up and separation procedures

Course Outcomes: At the end of this course, students should be able to:

CO1: How to calculate limiting reagent, theoretical yield, and percent yield

CO2: How to perform common laboratory techniques including reflux, distillation, recrystallization, vacuum filtration.

CO3: How to critically evaluate data collected to determine the identity, purity, and percent yield of products and to summarize findings in writing in a clear and concise manner

Syllabus

Course Details

Unit	Learning Units	Practical Hours
I	Organic preparations: i. Acetylation of one of the following compounds: amines (aniline, o-, m-, ptoluidines and o-, m-, p-anisidine) and phenols (β -naphthol, vanillin, salicylic acid) by any one method: a. Using conventional method. b. Using green approach ii. Benzoylation of one of the following amines (aniline, o-, m-, p- toluidines and o-, m-, p-anisidine) iii. Nitration of any one of the following: a. Acetanilide/nitrobenzene by conventional method b. Salicylic acid by green approach (using ceric ammonium nitrate).	20 Hr
II	IR Spectral Analysis IR Spectral Analysis of the following functional groups with examples a) Hydroxyl groups b) Carbonyl groups c) Amino groups d) Aromatic groups	10Hr

Text Book

Laboratory Manual

Course Delivery method: Demonstration of Practical

Course has focus on:

Employability / Entrepreneurship

**ANDHRA PRADESH STATE COUNCIL OF HIGHER EDUCATION REVISED
UG SYLLABUS UNDER CBCS**

(Implemented from Academic Year, 2020-21)

PROGRAMME: FOUR YEAR B.Sc.(Hons)

Domain Subject: CHEMISTRY

Skill Enhancement Courses (SECs) for Semester V, from 2022-23

(Syllabus with Learning Outcomes, References, Co-curricular Activities & Model Q.P. Pattern)

Structure of SECs for Semester–V (To choose One pair from the Five alternate pairs of SECs)

Univ. Code	Course NO. 6&7	Name of Course	Th. Hrs / Week	IE Marks	EE Marks	Credits	Prac. Hrs./ Wk	Marks	Credits
	6A	Synthetic Organic Chemistry	3	25	75	3	3	50	2
	7A	Analysis of Organic Compounds	3	25	75	3	3	50	2

OR

	6B	Analytical Methods in Chemistry-I	3	25	75	3	3	50	2
	7B	Analytical Methods in Chemistry-I	3	25	75	3	3	50	2

OR

	6C	Industrial Chemistry-1	3	25	75	3	3	50	2
	7C	Industrial Chemistry-2	3	25	75	3	3	50	2

OR

	6D	Environmental Chemistry	3	25	75	3	3	50	2
	7D	Green Chemistry and Nanotechnology	3	25	75	3	3	50	2

OR

	6E	Analytical Methods in Chemistry	3	25	75	3	3	50	2
	7E	Cosmetics and Pharmaceutical Chemistry	3	25	75	3	3	50	2

Note-1: For Semester–V, for the domain subject Chemistry, any one of the five pairs of SECs shall be chosen as courses 6 and 7, i.e., 6A&7A or 6B&7B or 6C&7C or 6D&7D or 6E&7E. The pair shall not be broken (ABC allotment is random, not on any priority basis).

Note-2: One of the main objectives of Skill Enhancement Courses (SEC) is to inculcate skills related to the domain subject in students. The syllabus of SEC will be partially skill oriented. Hence, teachers shall also impart practical training to students on the skills embedded in syllabus citing related real field situations



A.G & S.G. SIDDHARTHA DEGREE COLLEGE OF

ARTS & SCIENCE

Vuyyuru-521165

NAAC reaccredited at "A" level

Autonomous -ISO 9001 – 2015 Certified

Title of the Paper: Analytical Methods in Chemistry-I

Semester: V

Course Code	CHE-501C-6B SEC	Course Delivery Method	Class Room / Blended Mode
Credits	3	CIA Marks	30
No. of Lecture Hours / Week	3	Semester End Exam Marks	70
Total Number of Lecture Hours	45	Total Marks	100
Year of Introduction : 2022-23	Year of Offering: 2022-23	Year of Revision: -----	Percentage of Revision: 0

Course Outcomes:

Students after successful completion of the course will be able to:

CO1. Remember the basic concepts of quantitative analysis data treatment, separation techniques and analysis of water (PO7)

CO2. Acquire knowledge on the concepts quantitative analysis data treatment, separation techniques and analysis of water (PO1, PO7)

CO3. Apply the conceptual knowledge gained in the areas of quantitative analysis data treatment, separation techniques and analysis of water in the chosen job role (PO1)

CO4. Analyse that how far the quantitative methods, data treatment methods separation techniques and Analysis of water (PO1).

Syllabus

Course Details

Unit	Learning Units	Lecture Hours
I	Quantitative analysis-1 (Marks Weightage-10+5+5) 1. A brief introduction to analytical methods in chemistry 2. Principles of volumetric analysis, concentration terms- Molarity, Normality, v/v, w/v, ppm and ppb, preparing solutions- Standard solution, primary standards and secondary standards. 3. Description and use of common laboratory apparatus- volumetric flask, burette, pipette, beakers, measuring cylinders.	10 Hr
II	Quantitative analysis-2 (Marks Weightage-10+10+5) 1. Principles of volumetric analysis: Theories of acid-base (including study of acid-base titration curves), redox, complexometric, iodometric and precipitation titrations-choice of indicators for the saturations. 2. Principles of gravimetric analysis: precipitation, coagulation, peptization, co-precipitation, post precipitation, digestion, filtration, and washing of precipitate, drying and ignition.	12 Hr
III	Treatment of analytical data (Marks Weightage-10+10+5) Types of errors- Relative and absolute, significant figures and its importance, accuracy – methods of expressing accuracy, errors- Determinate and indeterminate and minimization of errors, precision-methods of expressing precision, standard deviation and confidence limit.	8 Hr
IV	Separation techniques (Marks Weightage-10+10+5+5)	5 Hr

	<p>1. Solvent Extraction: Introduction, principle, techniques, factors affecting solvent extraction, Batch extraction, continuous extraction and counter current extraction. Synergism. Application-Determination of Iron (III).</p> <p>2. Ion Exchange method: Introduction, action of ion exchange resins, applications</p>	
V	<p>Analysis of water (Marks weightage 10+5)</p> <p>Determination of dissolved solids, total hardness of water, turbidity, alkalinity, Dissolved oxygen, COD, determination of chloride using Mohr's method</p>	10Hr

III References

1. Analytical Chemistry by Gary D.Christian, Purnendu K.Dasgupta and KevinA.Schug,Seventh edition, Wiley.
2. Text book of Vogel's Quantitative Chemical Analysis, Sixth edition, Pearson.
3. Text book of Environmental Chemistry and Pollution Control by S.S.Dara andD.D.Mishra, Revised edition, S Chand & Co Ltd.

Text Books:

1. Instrumental methods of chemical analysis by B K Sharma
2. Separation methods MN Sastry

Reference materials on the web/web links:

1. [https://chem.libretexts.org/Bookshelves/Analytical_Chemistry/Supplemental_Modules_\(Analytical_Chemistry\)/Quantifying_Nature/Volumetric_Chemical_Analysis_\(Shiundu\)/14.1%3A_Sampling_and_Statistical_Analysis_of_Data](https://chem.libretexts.org/Bookshelves/Analytical_Chemistry/Supplemental_Modules_(Analytical_Chemistry)/Quantifying_Nature/Volumetric_Chemical_Analysis_(Shiundu)/14.1%3A_Sampling_and_Statistical_Analysis_of_Data)
2. <https://vlab.amrita.edu/?sub=2&brch=190&sim=338&cnt=1>

IV Co-Curricular Activities:

a) Mandatory (Lab/field training of students by teacher (lab: 10 + field: 05) :

1.For Teacher: Training of students by the teacher in laboratory and field for not less than 15 hours on the field techniques/skills of calibration of pH meter, Strong acid vs strong base titration using pH meter, determination of chloride ion, estimation of water quality parameters and estimation of Iron(II).

Google classroom created during instruction of course by the teacher concerned for sharing relevant material and conducting exams.

2. For Student: Student shall visit a related industry/chemistry laboratory in universities/research organizations/private sector facility and observe. Write their observations and submit a hand written fieldwork/project work report not exceeding 10 pages in the given format to the teacher.

3. Max marks for Fieldwork/project work Report: 05.

4. Suggested Format for Fieldwork/project work: Title page, student details, index page, details of place visited, observations, findings, and acknowledgements.

5. Unit tests (IE).

b) Suggested Co-Curricular Activities

1. Training of students' by related industrial experts.

2. Assignments, Seminars and Quiz (on related topics).

3. Visits to facilities, firms, research organizations etc.

4. Invited lectures and presentations on related topics by field/industrial experts.

A.G. & S.G.SIDDHARTHA DEGREE COLLEGE OF ARTS & SCIENCE

(AUTONOMOUS), VUYYURU.

(Accredited at "A" Grade by NAAC, Bangalore)

Model Paper

SEMESTER – V	PAPER-V	PAPER CODE : CHE-501CSEC
PAPER TITLE : Analytical Methods in Chemistry-I Paper 6B		
ACADEMIC YEAR-2022-2023		

Time: 3Hours

Maximum marks: 70

Minimum marks: 28

Answer any FOUR of the following. Each question carries 5 marks. 4X5=20

1. Explain the preparation of v/v based with suitable examples
2. Discuss the detail about primary and secondary standards with suitable examples
3. Explain the need of drying the precipitate in gravimetric analysis
4. Define accuracy and explain the methods of expressing accuracy
5. Discuss the principal and theory involved in solvent extraction
6. Explain about resins
7. Explain about COD

SECTION-B

Answer any FIVE questions. Each question carries 10 marks. 5X10=50

8. Describe the role of the following apparatus in analytical chemistry I) Volumetric flask II) Burette III) Pipette
9. Elaborate the theory involved in complexometric and acid base titrations
10. Write a note on the following terms in gravimetric analysis I) Precipitation II) Digestion III) Filtration
11. Define error, discuss in detail about various types of errors encountered in quantitative analysis
12. Elaborate the methods used for minimization of errors
13. Discuss the various factors which effect solvent extraction

14. Explain in detail about role of Ion exchange resins in separation of compounds

15. Explain the following (a) turbidity (b) alkalinity

**The Guidelines to be followed by the question paper setters in chemistry for the
V- Semester - end exams**

SEMESTER – V	PAPER-V	PAPER CODE : CHE-501-6B
PAPER TITLE : Analytical Methods in Chemistry-I Paper 6B		
ACADEMIC YEAR-2022-2023		

Weightage for the question paper

syllabus	Section-A (Short answer questions)	Section-B (essay questions)
Unit-1 (20 Marks)	1+1	1
Unit-2 (25Marks)	1	1+1
Unit-3 (25Marks)	1	1+1
Unit-4 (30Marks)	1+1	1+1
Unit-5 (15 Marks)	1	1

- Each Short answer question carries 5 marks in Section –A
- Each Essay question carries 10 marks in Section –B
- The Question papers setters are requested to cover all the topics in the syllabus stipulated as per the weightage given by us.

A.G. & S.G.SIDDHARTHA DEGREE COLLEGE OF ARTS & SCIENCE (AUTONOMOUS),
VUYYURU.

(Accredited at "A" Grade by NAAC, Bangalore)

PRACTICAL SYLLABUS

Laboratory Course-VI

Practical Paper – V Analytical methods in chemistry-I Practical syllabus	PAPER CODE : CHE-501 P ACADEMIC YEAR-2022-2023
--	---

Analytical methods in Chemistry-1-PRACTICAL SYLLABUS

(Skill Enhancement Course (Elective), Credits: 02)

Practical Hrs ;45 (3hr/W)

I Learning Outcomes: On successful completion of this practical course, student shall be able to:

- CO1. Estimate Iron (II) using standard Potassium dichromate solution (PO1)
- CO2. Learn the procedure for the estimation of total hardness of water (PO7)
- CO3. Demonstrate the determination of chloride using Mohr's method (PO1, PO7)
- CO4. Acquire skills in the operation and calibration of pH meter (PO1)

II Practical (Laboratory) Syllabus :(30hrs)

1. Estimation of Iron (II) using standard Potassium dichromate solution (using DPA indicator)
2. Estimation of total hardness of water using EDTA
3. Determination of chloride ion by Mohr's method
4. Study the effect on pH of addition of HCl/NaOH to solutions of acetic acid, sodium acetate and their mixtures.
5. Preparation of buffer solutions of different pH (i) Sodium acetate-acetic acid, (ii) Ammonium chloride-ammonium hydroxide.
6. pH metric titration of (i) strong acid vs. strong base, (ii) weak acid vs. strong base.
7. Determination of dissociation constant of a weak acid.

II Lab References:

1. Text book of Vogel's Quantitative Chemical Analysis, Sixth edition, Pearson.

SCHEME OF VALUATION

INTERNAL MARKS- Record-10M

1. EXTERNAL MARKS-40

- Practical -30M
- Viva questions = 10 M

TOTAL = 50 M_



A.G & S.G. SIDDHARTHA DEGREE COLLEGE OF

ARTS & SCIENCE

Vuyyuru-521165

NAAC reaccredited at "A" level

Autonomous -ISO 9001 – 2015 Certified

Title of the Paper: Analytical Methods in Chemistry-2

Semester: V

Course Code	CHE-502C-7BSEC	Course Delivery Method	Class Room / Blended Mode
Credits	3	CIA Marks	30
No. of Lecture Hours / Week	3	Semester End Exam Marks	70
Total Number of Lecture Hours	45	Total Marks	100
Year of Introduction : 2022 - 23	Year of Offering: 2022 - 23	Year of Revision: -----	Percentage of Revision: 0

Learning Outcomes: Students after successful completion of the course will be able to:

CO1. Remember the basic concepts of Chromatography like paper, TLC, Column, GC & HPLC (PO7)

CO2. Understand the significance of paper, TLC, Column, GC & HPLC in separation and identification of compounds (PO1, PO7) .

CO3. Apply the conceptual knowledge gained in the techniques of chromatography in separating and identifying the chemical compounds as and when required (PO1).

CO4. Analyse that how far one chromatographic technique is much use full in separation and identification of compounds over the other chromatographic technique (PO1, PO7).

Syllabus

Course Details

Unit	Learning Units	Lecture Hours
I	<p>Chromatography-Introduction and classification (Marks weightage 10+5)</p> <p>Principle, Classification of chromatographic methods, Nature of adsorbents, eluents, R_f values, factors affecting R_f values.</p>	7 hr
II	<p>TLC and paper chromatography (Marks weightage 10+10+5+5)</p> <p>1. Thin layer chromatography: Principle, Experimental procedure, preparation of plates, adsorbents and solvents, development of chromatogram, detection of spots, applications and advantages.</p> <p>2. Paper Chromatography: Principle, Experimental procedure, choice of paper and solvents, various modes of development- ascending, descending, radial and two dimensional, applications.</p>	12 hr
III	<p>Column chromatography (Marks weightage 10+10+5)</p> <p>1. Column chromatography: Principle, classification, Experimental procedure, stationary and mobile phases, development of the Chromatogram, applications, factors affecting the column efficiency.</p> <p>2. Applications:- Separation of Methylene Blue and Fluorene by column chromatography.</p>	10 Hr
IV	<p>Gas chromatography: (Marks weightage 10+5+5)</p> <p>Basic principles. Different types of GC techniques. Selection of columns and carrier gases. Instrumentation. Detectors-Thermal conductivity detector, Flame ionization detector, R_f values. Applications in the separation of amino acids & estrogens</p>	8 hr

V	High Performance liquid chromatography (HPLC) (Marks weightage 10+10+5) Basic principles. Normal and reversed Phases. Selection of column and mobile phase. Instrumentation. Detectors- RID, UV detector R_f values. Applications in the separation, separation of anions, barbiturates, tropane alkaloids.	8 Hr
---	---	-------------

III References

1. Fundamental so Analytical Chemistry by F.James Holler, Stanley R Crouch, Donald M. Westand Douglas A.Skoog, Ninth edition, Cengage.
2. Analytical Chemistry by Gary D.Christian, Purnendu K.Dasgupta and KevinA.Schug, Seventh edition, Wiley.
3. Quantitative analysis by R.A.Day Jr. and A.L.Underwood, Sixth edition, Pearson.
4. Text book of Vogel's Quantitative Chemical Analysis, Sixth edition/ Pearson.

Text Books:

1. Instrumental methods of chemical analysis by B K Sharma
2. Instrumental methods of chemical analysis by Gurudeep & Chatwal Anand

Reference materials on the web/web links:

1. [https://chem.libretexts.org/Bookshelves/Analytical_Chemistry/Supplemental_Modules_\(Analytical_Chemistry\)/Instrumental_Analysis/Chromatography/Gas_Chromatography](https://chem.libretexts.org/Bookshelves/Analytical_Chemistry/Supplemental_Modules_(Analytical_Chemistry)/Instrumental_Analysis/Chromatography/Gas_Chromatography)
2. <https://lab-training.com/hplc-high-performance-liquid-chromatography/>

VI Co-Curricular Activities:

a) Mandatory :(Lab/field training of students by teacher (lab: 10+ fields: 05):

1. For Teacher: Training of students by the teacher in laboratory and field for not less than 15 hours on the field techniques/skills of determination of hardness of water, using the calorimeter and or Spectrophotometer, preparation of TLC plate, identification of spots in TLC and Paper chromatographic techniques, loading of column, selection of solvent system, separation of amino acids and dyes mixture using chromatographic techniques.

Google classroom created during instruction of course by the teacher concerned for sharing relevant material and conducting exams.

2. For Student: Student shall visit a related industry/chemistry laboratory in universities/research organizations/private sector facility and observe the chromatographic

techniques used for the separation of compounds. Write their observations and submit a hand written fieldwork/project work report not exceeding 10 pages in the given format to the teacher.

3. Max marks for Fieldwork/project work Report: 05.

4. Suggested Format for Fieldwork/project work: Title page, student details, index page, details of place visited, observations, findings, and acknowledgements.

5. Unit tests (IE).

b) Suggested Co-Curricular Activities

1. Training of students by related industrial experts.

2. Assignments, Seminars and Quiz (on related topics).

3. Visits to facilities, firms, research organizations etc.

4. Invited lectures and presentations on related topics by field/industrial experts.

A.G. & S.G.SIDDHARTHA DEGREE COLLEGE OF ARTS & SCIENCE

(AUTONOMOUS), VUYYURU.

(Accredited at “A” Grade by NAAC, Bangalore)

Model Paper

SEMESTER – V	PAPER-V	PAPER CODE : CHE-502-7BSEC
PAPER TITLE : Analytical Methods in Chemistry-2		Paper 7B
ACADEMIC YEAR-2022-2023		

Time: 3Hours

Maximum marks: 70

Minimum marks: 28

SECTION-A

Answer any FOUR of the following. Each question carries 5 marks. 4X5=20

1. What is the basic principle involved in chromatography, explain nature of adsorbents
2. How to prepare TLC plates
3. Explain Ascending and descending techniques in paper chromatography
4. Explain the classification of column chromatography
5. Explain the schematic diagram of G.C
6. Explain about detectors in G.C
7. Explain schematic diagram of HPLC

SECTION-B

Answer any FIVE questions. Each question carries 10 marks. 5X10=50

8. How do the chromatographic methods are classified? Explain any one
9. Discuss the applications of TLC
10. Explain the applications of paper chromatography
- 11 Explain the factors effecting the column efficiency in CC
12. Discuss the separation of methylene blue and fluorescein by C C
13. Explain the separation of Amino acids by G.C
14. Explain the different detectors used in HPLC
15. Explain the separation of Anions and Barbiturates by HPLC

**The Guidelines to be followed by the question paper setters in chemistry for the
V- Semester - end exams**

SEMESTER – V	PAPER-V	PAPER CODE : CHE-502C-7B
PAPER TITLE : Analytical Methods in Chemistry-2 Paper 7B ACADEMIC YEAR-2022-2023		

Weightage for the question paper

syllabus	Section-A (Short answer questions)	Section-B (essay questions)
Unit-1 (15Marks)	1	1
Unit-2 (30Marks)	1+1	1+1
Unit-3 (25 Marks)	1	1+1
Unit-4 (20Marks)	1+1	1
Unit-5 (25 Marks)	1	1+1

- Each Short answer question carries 5 marks in Section –A
- Each Essay question carries 10 marks in Section –B
- The Question papers setters are requested to cover all the topics in the syllabus stipulated as per the weightage given by us.

**A.G. & S.G.SIDDHARTHA DEGREE COLLEGE OF ARTS & SCIENCE
(AUTONOMOUS), VUYYURU.**

(Accredited at “A” Grade by NAAC, Bangalore)

PRACTICAL SYLLABUS

Laboratory Course-VII

Practical Paper – V Analytical methods in chemistry-2 Practical syllabus	PAPER CODE : CHE-502 P SEC ACADEMIC YEAR-2022-2023
---	---

Analytical methods in Chemistry-2

PRACTICAL SYLLABUS

(Skill Enhancement Course (Elective), Credits: 02)

Practical Hrs./Week: 3

Learning Outcomes:

On successful completion of this practical course, student shall be able to:

CO1. Perform the separation of a given dye mixture using TLC (PO1)

CO2. Learn the preparation of TLC plates (PO1, PO7)

CO3. Demonstrate the separation of mixture of amino acids using paper chromatography (PO1)

CO4. Acquire skills in using column chromatography for the separation of dye mixture (PO7)

II Practical (Laboratory) Syllabus: (30hrs)

1. Separation of a given dye mixture (methyl orange and methylene blue) using TLC (using alumina as adsorbent).

2. Separation of different amino acids using paper chromatography.

3. Separation of given mixture of amino acids (glycine and phenyl alanine) using ascending paper chromatography.

4. Estimation of Fe⁺² by using thiocyanate by calorimeter.

5. Separation of sugars using TLC

6. Verification of Beer lambert's law. (Using potassium permanganate solution) using colorimeter /spectrophotometer.

III Lab References:

1. Text book of Vogel's Quantitative Chemical Analysis, Sixth edition, Pearson.

2. Vogel A. I. Practical Organic Chemistry, Longman Group Ltd.
3. Bansal R.K. Laboratory Manual of Organic Chemistry, Wiley- Eastern.
4. Ahluwalia V. K. and Aggarwal R. Comprehensive Practical Organic Chemistry, University press.
5. Mann F.Gand Saunders B.C, Practical Organic Chemistry, Pearson Education.

SCHEME OF VALUATION

1. INTERNAL MARKS- Record-10M

2. EXTERNAL MARKS-40

- **Practical-30M**
- **Viva questions = 10 M**

TOTAL = 50 M

SEMESTER – III (SDC)	PAPERCODE:SDCCHET01
PAPER TITLE : FOOD ADULTERATION	

UNIT-I: Total: 30Hrs (2h/week) 02 Credits

Common Foods and Adulteration (10+10+5+5) 10Hrs

Common Foods subjected to Adulteration-Adulteration-Definition –Types; Poisonous substances, Foreign matter, cheap substitutes, Spoiled parts. Adulteration through Food Additives –Intentional and incidental. General Impact on Human Health.

UNIT-II :

Adulteration of Common Foods and Methods of Detection (10+10+5+5) 10Hrs

Means of Adulteration Methods of Detection Adulterants in the following Foods; Milk, Oil, Grain, Sugar, Spices and Condiments, Processed Food, Fruits and Vegetables. Additives and Sweetening agents (at least three methods of detection for each food item).

UNIT-III:

Present Laws and Procedures on Adulteration (10+10) 10Hrs

Highlights of Food Safety and Standards Act 2006 (FSSA) –Food Safety and Standards Authority of India- Rules and Procedures of Local Authorities.Role of Voluntary Agencies Suchas, Agmark, I.S.I. Quality control laboratories of Companies, Private testing laboratories, Quality control laboratories of Consumer co-operatives.

Consumer Education, Consumer’s problems, rights and responsibilities, COPRA2019- Offenses and Penalties-Procedures to Complain –Compensation to Victims.

Reference books and Websites:

1. A first course in Food Analysis – A.Y. Sathe, New Age International (p) Ltd, 1999
2. Food Safety, case studies – Ramesh.V.Bhat, NIN, 1992
3. [https://old.fssai.gov.in/Portals/0/Pdf/](https://old.fssai.gov.in/Portals/0/Pdf/Draft%20Manuals/Beverages%20and%20Confectionary.pdf) Draft Manuals/ Beverages and Confectionary.pdf
4. <https://www.fssai.gov.in/>
5. <https://indianlegalsolution.com/laws-on-food-adulteration/>
6. <https://fssai.gov.in/dart/>
7. <https://byjus.com/biology/food-adulteration/>

A.G. & S.G.SIDDHARTHA DEGREE COLLEGE OF ARTS & SCIENCE (AUTONOMOUS), VUYYURU.
ACADEMIC YEAR-2022-23

SEMESTER – III (SDC)	COURSE CODE:SDCCHET01
PAPER TITLE : FOOD ADULTERATION	

Time: 2 Hours

Maximum marks: 40

Pass marks:

SECTION-A

Answer any TWO Questions. Each question carries 5 marks. 2X5=10Marks

- 1.
- 2.
- 3.
- 4.

SECTION-B

Answer any THREE Questions. Each question carries 10 marks. 3X10=30M

- 5.
- 6.
- 7.
- 8.
- 9.
- 10.

**The Guidelines to be followed by the question paper setters in Chemistry for the
II-Semester - end exams. ACADEMIC YEAR-2022-23**

Weightage for the question paper-FOOD ADULTERATION

syllabus	Section-A (Short answer questions)	Section-B (Essay questions)
Unit-1 (30 Marks)	1+1	1+1
Unit-2 (30 Marks)	1+1	1+1
Unit-3 (20 Marks)	-----	1+1

- Each Short answer question carries 5 marks in Section –A
- Each Essay question carries 10 marks in Section –B
- The Question papers setters are requested to cover all the topics in the syllabus stipulated as per the weightage given by us.

**A.G& S.G.SIDDHARTHA DEGREE COLLEGE OF ARTS &
SCIENCE**

VUYYURU-521165, KRISHNA Dt., A.P.(Autonomous)

Accredited by NAAC with "A" Grade

2022-2023



DEPARTMENT OF COMMERCE

MINUTES OF BOARD OF STUDIES

ODD SEMESTER

10-02-2023

Minutes of the meeting of Board of studies in Commerce for the Autonomous courses of
AG & SG Siddhartha Degree College of Arts & Science, Vuyyuru, held at
10.30 A.M on 13-4-2023

N.Vasanatha Rao ... Presiding

Members Present:

1)  Chairman Head, Department of Commerce
(N.Vasanatha Rao) AG & SG S Degree College of Arts & Science
Vuyyuru

2)  University Nominee
(Dr.N.A Francis Xavier) Head, Department of Commerce
Andhra Loyola College.
Vijayawada (9440524321)
nafrancisxavier@gmail.com

3)  Subject Expert
(Dr.K.Venkateswarlu,) Lecturer in Commerce
V.S.R Govt. Degree & P.G College
Movva (9848341412)
gdcjkc.movva@gmail.com

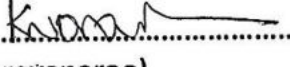
4)  Subject Expert
(K.Narayanarao) Lecturer in Commerce
P.B.Siddhartha College of arts and Science
Vijayawada. (9885038196)
hodcommerce@pbsiddhartha.ac.in

5) Member
(Sri V.Punnarao) Industrialist
General Manager (Agriculture)
K.C.P & IC Ltd
Vuyyuru.

6) Member
(Sri V.Balaji) Alumni
Chartered Accountant
Managing Partner
Balaji V & Co (9052190007)
Vuyyuru (cabalajinco@gmail.com)

7).......... Member
(Sri V. Gopi Chand)

Lecturer in Commerce
AG & SG S Degree College of Arts & Science
Vuyyuru

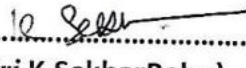
8).......... Member
(Sri K. Sekhar Babu)

Lecturer in Commerce
AG & SG S Degree College of Arts & Science
Vuyyuru

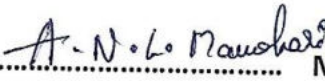
9).......... Member
(Ms A.N.L Manohari)

Lecturer in Commerce
AG & SG S Degree College of Arts & Science
Vuyyuru

10).......... Member
(Smt. Y. Swarna Iatha)

Lecturer in Commerce
AG & SG S Degree College of Arts & Science
Vuyyuru

11).......... Member
(K. Kiran Kumar)

Lecturer in Commerce
AG & SG S Degree College of Arts & Science
Vuyyuru

Agenda of B.O.S Meeting:

1. To discuss and recommend the Syllabi, Model Question Papers and Guidelines to be followed by question paper setters in Commerce for the 2nd Semester as per the guidelines and instruction under CBCS prescribed by APSICHE from the Academic Year 2022-2023.
2. To discuss and recommend the Syllabi, Model Question Papers and Guidelines to be followed by question paper setters in Commerce for the 4th Semester as per the guidelines and instructions under CBCS prescribed by Krishna University from the Academic Year 2022-2023.
3. To recommend the Blue print of V Semester of B.Com (General & Computers) for the Academic Year 2022-2023.
4. To recommend the Teaching and Evaluation methods to be followed under CBCS
5. Any other suggestions regarding Certificate Course, Seminars, Workshops, Guest Lectures to be organized.
6. Any other matter.

RESOLUTIONS

1. Discussed and recommended the Same syllabi, Model Question Papers and Guidelines for question paper setters in Commerce for the 1st Semester of **I B.Com., (general, computer& e-commerce)** for the Academic year 2022-2023.prescribed by APSCHE
2. Discussed and recommended the Changed syllabi, Model Question Papers for question paper setters in Commerce for the 3rd Semester of **II B.Com., (general, computer& e-commerce)** for the Academic year 2022-2023. There is a change in syllabi of Advanced Accounting A new **“Topic Conversion of single entry into Double Entry System”** Introduced in addition to the syllabus in II Unit. In Business Statistics **“Diagrams and Graphic Presentation of data”** was deleted in Unit I. In Unit III **“Skeweness and Measures of Skeweness”** Introduced and A Topic Named **“Kurtosis”** was deleted. In Unit IV Two New Topics **“Analysis of Time series & Index Numbers”** Introduced.
3. Discussed and recommended the changed syllabi, Model Question Papers and Guidelines for question paper setters in Commerce for the 5th Semester of **III B.Com., (general, computers)** for the Academic year 2022-2023.prescribed by APSCHE
4. It is resolved to continue following Teaching and Evaluation methods for Academic year 2022-2023.

Teaching methods:

Besides the conventional methods of teaching, we use modern technology i.e. using of LCD projector, display on U boards etc, for better understanding of concepts.

Evaluation of a student is done by the following procedure:

Internal Assessment (IA)I B.Com (General ,Computers& e-Commerce)

- Out of maximum 100 marks in each paper 30 marks shall be allocated for internal assessment for I.B.Com (General, Computers& e-Commerce). Out of these 30 marks, 20 Marks are allocated for announced tests (i.e. IA-1 & IA-2). Two announced tests will be conducted and average of these two tests shall be deemed as the marks obtained by the student, and 5 marks are allocated for the assignment. And reaming 5 marks are allocated for attendance. There is no minimum passing for IA.

Internal Assessment (IA)IIB.Com (General ,Computers& e-Commerce)

- Out of maximum 100 marks in each paper 25 marks shall be allocated for internal assessment for II.B.Com (General ,Computers& e-Commerce). Out of these 25 marks, 20 Marks are allocated for announced tests (i.e. IA-1 & IA-2). Two announced tests will be conducted and average of these two tests shall be deemed as the marks obtained by the student, and remaining 5 marks are allocated for the assignment. There is no minimum passing for IA.

Internal Assessment (IA) III B.Com (General & Computers)

- Out of maximum 100 marks in each paper 30 marks shall be allocated for internal assessment B.Com (General & Computers). Out of these 30 marks, 20 Marks are allocated for announced tests (i.e. IA-1 & IA-2). Two announced tests will be conducted and average of these two tests shall be deemed as the marks obtained by the student, 5 marks allocated on the basis of candidate's percentage of attendance and remaining 5 marks are allocated for the assignment. There is no minimum passing for IA.

Semester End Examinations (SEE)

- The Semester Examinations will be in the form of a comprehensive examination covering the entire syllabus in each subject. It will be of 3 hours duration, with maximum 70 marks, for 1st year 75 marks for 2nd year and 70 marks for 3rd year irrespective of the number of credits allotted to it.
- Even though the candidate is absent for two IA exams/obtained zero marks, the external marks are considered (if he/she gets 40/70) and the result shall be declared as 'PASS'
- The pass mark shall be 28 out of 70 in the Semester end examination for I B.Com (General ,Computers & e-Commerce) and 3rd B.com (General&Computers)
- The pass mark shall be 30 out of 75 in the Semester end examination for IIB.Com(General ,Computers & e-Commerce)
- The maximum marks for each Paper shall be 100. (Internal 30 + External 70) for I B.Com (General ,Computers & e-Commerce) and III B.Com (General &Computers)
- The maximum marks for each Paper shall be 100. (Internal 30 + External 75) for II B.Com (General ,Computers & e-Commerce)
- Discussed and recommended to organize certificate course online/offline, seminars, Guest lectures, Online Examinations and Workshops to upgrade the knowledge of students for Competitive Examinations for the approval of the Academic Council.
- It is resolved to follow further changes if any in the Syllabus by the Competent Authority

5. It is resolved Introduce Value added course on Tally Prime in III sem .

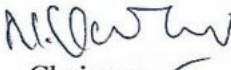
Chairman

Program me Specific Outcomes (PSO)

PSO1. Getting the knowledge and the importance of accounting and auditing Standards for the reliability of financial statements.

PSO2 Interpret the legal and environmental aspects of business and Analyze quantitative data in order to take business decisions

PSO3. Empowering the student to understand the accounting practices and Procedures followed by different business entities.

PSO4. Promising the Practical skills for a bright career as accounting officers, computer professionals, audit assistants, businessmen, entrepreneurs, managers with required knowledge in computers.

PSO5. Knowledge of major theories and models in key areas which motivate them to pursue higher studies / face competitive exams like SSC,P.C,BANK,R.R.B/ professional courses like CA,CS, ICWA and other courses.

Program outcomes (Pos)

PO1. Critical Thinking: Knowledgeable in the core disciplines of Commerce, Economics and Business through a number of specializations and practical exposure enables them to face the challenges in the field of Commerce

PO2. Effective Communication: Demonstrate proficiency in communicating competently in groups and organizations in English and in one Indian language,

PO3. Effective Citizenship: Ability to act with an informed awareness of issues and participate in civic life through volunteering.

PO4. Value- based development: Recognize values such as justice, trust, equity, fairness, kindness and, understand the moral Dimensions of your decisions, and accept responsibility for them.

PO5. Environment and Sustainability: Understand the issues of environmental contexts and Sustainable development.

PO6. Self-directed and Life-long Learning: promoting continuous development and improvement of the knowledge and skills needed for employment and personal fulfillment

SEMESTER – I

Course Code	Title of the Course	Instruction Hours per week	Credits	Evaluation		
				CIA MARKS	SEE	
					MARKS	DURATION
COMT11B	Fundamentals of Accounting (Gen, CA& E-Com)	5	4	30	70	3 Hrs.
COMT12A	Business Organization and Management (Gen& CA,)	5	4	30	70	3 Hrs.
COMT13	Business Environment (Gen)	5	4	30	70	3 Hrs.
COM14P	Principles of management (E-Com)	5	4	30	70	3Hrs
COMT15S	Insurance promotion (Gen, CA& E-Com)	2	2	15	35	2Hrs

SEMESTER-III

Course Code	Title of the Course	Instruction Hours per week	Credits	Evaluation		
				CIA MARKS	SEE	
		MARKS			MARKS	DURATION
COMT31	Advanced Accounting (Gen & CA, e-com)	5	4	25	75	3 Hrs.
COMT32	Business Statistics (Gen & CA,)	5	4	25	75	3 Hrs.
COMT33	Marketing (Gen)	5	4	25	75	3Hrs.
COMT34	E-Commerce(e-com)	5	4	25	75	3Hrs
COMT 35S	Online Business (Gen & CA, e-com)	2	2	10	40	2Hrs
COM36SI	Insurance promotion (Gen, CA& E-Com)	2	2	10	40	2Hrs

SEMESTER- V / VI

Course Code	Title of the Course	Instruction Hours per week	Credits	Evaluation		
				CIA MARKS	SEE	
		MARKS			DURATIO N	
CACA-501 G/C	Advanced Corporate Accounting(GEN&CA)	5	4	30	70	3 Hrs.
CSSA-502 G/C	Software Solutions to Accounting(GEN&CA)	5	4	30	70	3 Hrs.
CAMP-503 G/C	Advertising and Media Planning(GEN&CA)	5	4	30	70	3 Hrs.
CSPP -504 G/C	Sales Promotion and Practice(GEN&CA)	5	4	30	70	3 Hrs.
CDM -505 G	Digital Marketing(GEN)	5	4	30	70	3 Hrs.
CSM -506 G	Service Marketing(GEN)	5	4	30	70	3 Hrs.



A. G & S.G. SIDDHARTHA DEGREE COLLEGE OF ARTS & SCIENCE

Vuyyuru-521165.

NAAC recredited at 'A' level

Autonomous -ISO 9001 – 2015 Certified

TITLE OF THE PAPER: Fundamentals of Accounting

Semester: I

Course Code	COMT11B	Course Delivery Method	Class Room / Blended Mode - Both
Credits	4	CIA Marks	30
No. of Lecture Hours / Week	5	Semester End Exam Marks	70
Total Number of Lecture Hours	75	Total Marks	100
Year of Introduction:	Year of Offering: 2021 - 22	Year of Revision: ---	Percentage of Revision: 0%
CLASS:	I.B.COM., (gen/computer/E-commerce)		

Learning Outcomes:

- 1) The main objective of fundamental accounting is to prepare final accounts, otherwise known as the financial statements
- 2) To provide information that is useful for making business and economic decisions
3. The students of this course will be active learners and develop awareness of emerging trends in fundamentals of accounting,
4. The course will provide decision making skills to the students in the financial analysis context,
5. This course will enable the students to combine theoretical knowledge and practice of fundamentals of accounting.

COURSE OUTCOMES:

At the end of the course, the student will be able to

CO 1: Identify transactions and events that need to be recorded in the books of accounts.

CO 2: Equip with the knowledge of accounting process and preparation of final accounts of sole trader.

CO 3: Develop the skill of recording financial transactions and preparation of reports in accordance with GAAP.

CO 4: Analyze the difference between cash book and pass book in terms of balance and make reconciliation.

CO 5: Critically examine the balance sheets of a sole trader for different accounting periods.

TITLE OF THE PAPER: Fundamentals of Accounting

Semester: I

Syllabus

Unit	Learning Units	Lecture Hours
I	Introduction : Need for Accounting – Definition – Objectives, – Accounting Concepts and Conventions – GAAP - Accounting Cycle - Classification of Accounts and its Rules – Bookkeeping and Accounting - Double Entry Book-Keeping - Journalizing - Posting to Ledgers, Balancing of Ledger Accounts (including Problems).	15
II	Subsidiary Books: Types of Subsidiary Books - Cash Book, Three-column Cash Book- Petty Cash Book (including Problems).	15
III	Trial Balance and Rectification of Errors: Preparation of Trial balance - Errors – Meaning – Types of Errors – Rectification of Errors – Suspense Account (including Problems)	15
IV	Bank Reconciliation Statement: Need for Bank Reconciliation - Reasons for Difference between Cash Book and Pass Book Balances- Preparation of Bank Reconciliation Statement - Problems on both Favourable and Unfavorable Balance (including Problems).	15
V	Final Accounts:Preparation of Final Accounts: Trading account – Profit and Loss account – Balance Sheet – Final Accounts with Adjustments (including Problems).	15

Test Book Prefer:

1. Financial Accounting By: S.P.Jain& K.L. Narang. Kalyani Publishers – New Delhi.

Reference text books:

2. Financial Accounting – Himalaya Publishers
3. Financial Accounting – Pragthiprakesh Publishers

Suggested Co-Curricular Activities:

1. Quiz Programs
2. Problem Solving Exercises
3. Seminar
4. Group Discussions on problems relating to topics covered by syllabus
5. Collection of proforma of bills and promissory notes
6. Examinations (Scheduled and surprise test)
7. Bridge Course for Non-commerce Students



A. G & S.G. SIDDHARTHA DEGREE COLLEGE OF ARTS & SCIENCE

Vuyyuru-521165.

NAAC reaccruited at 'A' level

Autonomous -ISO 9001 – 2015 Certified

Model Question Paper

Commerce	I B.Com (Gen, CA &e-Com)	Semester-I	COMT11B
----------	--------------------------	------------	---------

Fundamentals of Accounting

Max. Marks: 70

5 x14 = 70

Answer the following

Unit - I

1. A) -----10(MARKS)
B) -----4(MARKS)

(OR)

- C) -----10(MARKS)
D) -----4(MARKS)

Unit – II

2. A) -----10(MARKS)
B) -----4(MARKS)

(OR)

- C) -----10(MARKS)
D) -----4(MARKS)

Unit – III

3. A) -----10(MARKS)
B) -----4(MARKS)

(OR)

- C) -----10(MARKS)
D) -----4(MARKS)

Unit – IV

4. A) -----10(MARKS)
B) -----4(MARKS)

(OR)

- C) -----10(MARKS)
D) -----4(MARKS)

Unit - V

5. A) -----10(MARKS)
B) -----4(MARKS)

(OR)

- C) -----10(MARKS)
D) -----4(MARKS)



A. G & S.G. SIDDHARTHA DEGREE COLLEGE OF ARTS & SCIENCE

Vuyyuru-521165.

NAAC reaccredited at 'A' level

Autonomous -ISO 9001 – 2015 Certified

TITLE OF THE PAPER: Principles of Management

Semester: I

Course Code	COMT14P	Course Delivery Method	Class Room / Blended Mode - Both
Credits	4	CIA Marks	30
No. of Lecture Hours / Week	5	Semester End Exam Marks	70
Total Number of Lecture Hours	75	Total Marks	100
Year of Introduction:	Year of Offering: 2022 - 23	Year of Revision: ----	Percentage of Revision: 0%
CLASS:	I.B.COM., (E-commerce)		

Course Objectives:

- To understand about the importance of Management in an Organization.
- Knowing about the management thought into reality.
- To learn about the optimal Level of utilization of Resources.

Learning Outcomes:

At the end of the course, the student will be able to

- Understand different forms of business organizations.
- Comprehend the nature of Joint Stock Company and formalities to promote a Company.
- Describe the Social Responsibility of Business towards the society.
- Critically examine the various organizations of the business firms and judge the best among them.
- Design and plan to register a business firm. Prepare different documents to register a company at his own.
- Articulate new models of business organizations.

Syllabus

Unit	Learning Units	Lecture Hours
I	Introduction of Management Definition - Management - functions of management - principles of management - levels of management- Trends and Challenges of Management in Global Scenario.	15
II	Planning Nature and purpose of planning - Planning process - Types of plans - Objectives - Managing by objective (MBO) Strategies - Types of strategies	15
III	Organizing Nature and purpose of organizing - Organization structure Formal and informal groups organization - Line and Staff authority -Centralization and Decentralization - Delegation of authority	15
IV	Motivation Theories -Leadership Styles - Leadership theories - Communication - Barriers to effective communication.	15
V	Controlling Process of controlling - Types of control- Budgetary and non-budgetary, control techniques - Managing Productivity - Cost Control - Purchase Control-Maintenance Control - Quality Control	15

REFERENCES:

1. Gupta, Sharma and Bhalla; Principles of Business Management; Kalyani Publications.
 2. L. M. Prasad; Principles of Management; Sultan Chand and Sons, 6th edition.
 3. Harold Koontz & Heinz Weihrich "Essentials of Management", Tala McGraw-Hill, 1998
 4. Joseph L Massie "Essentials of Management", Prentice Hall of India, (Pearson) Fourth Edition, 2003.
- (5) Principles of Management, By Tripathi, Reddy Tala McGraw Hill

Curricular Activities:

Classroom activities: Face to face interactions in the class, conventional chalk dust method of teaching, using audio visual aids, synchronous, asynchronous and hybrid method of online, teaching by using suitable platform, spot tests, listing assignments, conduct quizzes, Google class rooms organizing group discussions, preparing question banks.

Library activities: Reading books, journals and magazines, glancing question papers of previous Years. Organization of activities like seminars, workshops and conferences

Co-Curricular Activities:

- Book Reading, Student Seminars, Debates
- Quiz Programme
- Assignments Field studies (Individual/Group)



A. G & S.G. SIDDHARTHA DEGREE COLLEGE OF ARTS & SCIENCE

Vuyyuru-521165.

NAAC recredited at 'A' level

Autonomous -ISO 9001 – 2015 Certified

Model Question Paper

Commerce	I B.Com (E-Com)	Semester-I	COMT14P
----------	-----------------	------------	---------

Principles of Management

Time: 3 Hours Max. Marks:70M

Answer the following

5 x14 = 70

Unit - I

1. A) -----10(MARKS)
B) -----4(MARKS)

(OR)

- C) -----10(MARKS)
D) -----4(MARKS)

Unit – II

2. A) -----10(MARKS)
B) -----4(MARKS)

(OR)

- C) -----10(MARKS)
D) -----4(MARKS)

Unit – III

3. A) -----10(MARKS)
B) -----4(MARKS)

(OR)

- C) -----10(MARKS)
D) -----4(MARKS)

Unit – IV

4. A) -----10(MARKS)
B) -----4(MARKS)

(OR)

- C) -----10(MARKS)
D) -----4(MARKS)

Unit - V

5. A) -----10(MARKS)
B) -----4(MARKS)

(OR)

- C) -----10(MARKS)
D) -----4(MARKS)



A. G & S.G. SIDDHARTHA DEGREE COLLEGE OF ARTS & SCIENCE

Vuyyuru-521165.

NAAC reaccredited at 'A' level

Autonomous -ISO 9001 – 2015 Certified

TITLE OF THE PAPER: Business Organization and Management

Semester: I

Course Code	COMT12A	Course Delivery Method	Class Room / Blended Mode - Both
Credits	4	CIA Marks	30
No. of Lecture Hours / Week	5	Semester End Exam Marks	70
Total Number of Lecture Hours	75	Total Marks	100
Year of Introduction:	Year of Offering: 2012 - 13	Year of Revision: ----	Percentage of Revision: 0%
CLASS:	I.B.COM., (gen/computer)		

Course Objectives:

CO1-Recall the basic knowledge on conceptual areas such as commerce trade and industry of different types of business organizations. (PO4, PO5)

CO2-Have a demonstrated understanding on nature purpose and importance of different types of organizations.(PO4, PO5)

CO3-Articulate the fundamentals of joint-stock company as per companies Act 2013. (PO2, PO4, PO5)

CO4-Appraise the documentation and incorporation stages of a company. (PO2, PO4, PO5)

CO5-Discuss and implement the managerial traits and talents essential for managing business. (PO1, PO4, PO5)

Learning Outcomes:

At the end of the course, the student will be able to

- Understand different forms of business organizations.
- Comprehend the nature of Joint Stock Company and formalities to promote a Company.
- Describe the Social Responsibility of Business towards the society.
- Critically examine the various organizations of the business firms and judge the best among them.
- Design and plan to register a business firm. Prepare different documents to register a company at his own.
- Articulate new models of business organizations.

Syllabus

Unit	Learning Units	Lecture Hours
I	Introduction Concepts of Business, Trade, Industry and Commerce: Business – Meaning, Definition, Features and Functions of Business - Trade Classification – Aids to Trade – Industry Classification and Commerce - Factors Influencing the Choice of Suitable form of Organization.	15
II	Forms of Business Organizations: Features, Merits and Demerits of Sole Proprietorship and Partnership Business - Features Merits and Demerits of Joint Stock Companies - Public Sector Enterprises (PSEs) - Multinational Corporations (MNCs)- Differences between Private Limited Public Limited Company.	15
III	Company Incorporation: Preparation of Important Documents for Incorporation of Company - Certificate of Incorporation and Certificate of Commencement of Business - Contents of Memorandum and Articles of Association – Content of Prospectus.	15
IV	Management: Meaning Characteristics - Fayol's 14 Principles of Management - Administration Vs. Management - Levels of Management.	15
V	Functions of Management: Different Functions of Management - Meaning – Definition – Characteristics Merits and Demerits of Planning - Principles of Organization – Line and staff of Organization.	15

Text book:

Business Organization and management – R.K.Sharma, Monika Aggarwal, Rahul Sharma.

Reference Books:

5. Business Organization - C.D.Balaji and G. Prasad, Margham Publications, Chennai.
6. Business Organization - R.K.Sharma and Shashi K Gupta, Kalyani Publications.
7. Business Organization & Management: Sharma Shashi K. Gupta, Kalyani Publishers.

Curricular Activities:

Classroom activities: Face to face interactions in the class, conventional chalk dust method of teaching, using audio visual aids, synchronous, asynchronous and hybrid method of online teaching by using suitable platform, spot tests, listing assignments, conduct quizzes, Google class rooms organizing group discussions, preparing question banks.

Library activities: Reading books, journals and magazines, glancing question papers of previous Years. Organization of activities like seminars, workshops and conferences

Co-Curricular Activities:

- Book Reading, Student Seminars, Debates
- Quiz Programme
- Assignments Field studies (Individual/Group)



A. G & S.G. SIDDHARTHA DEGREE COLLEGE OF ARTS & SCIENCE

Vuyyuru-521165.

NAAC recredited at 'A' level

Autonomous -ISO 9001 – 2015 Certified

Model Question Paper

Commerce	I B.Com (Gen, CA)	Semester-I	COMT12A
----------	-------------------	------------	---------

Business Organization and Management

Time: 3 Hours Max. Marks:70M

Answer the following

5 x14 = 70

Unit - I

6. A) -----10(MARKS)
B) -----4(MARKS)

(OR)

- C) -----10(MARKS)
D) -----4(MARKS)

Unit – II

7. A) -----10(MARKS)
B) -----4(MARKS)

(OR)

- C) -----10(MARKS)
D) -----4(MARKS)

Unit – III

8. A) -----10(MARKS)
B) -----4(MARKS)

(OR)

- C) -----10(MARKS)
D) -----4(MARKS)

Unit – IV

9. A) -----10(MARKS)
B) -----4(MARKS)

(OR)

- C) -----10(MARKS)
D) -----4(MARKS)

Unit - V

10. A) -----10(MARKS)
B) -----4(MARKS)

(OR)

- C) -----10(MARKS)
D) -----4(MARKS)



A. G & S.G. SIDDHARTHA DEGREE COLLEGE OF ARTS & SCIENCE

Vuyyuru-521165.
NAAC recredited at 'A' level
Autonomous -ISO 9001 – 2015 Certified

TITLE OF THE PAPER: Business Environment

Semester: I

Course Code	COMT13	Course Delivery Method	Class Room / Blended Mode - Both
Credits	4	CIA Marks	30
No. of Lecture Hours / Week	5	Semester End Exam Marks	70
Total Number of Lecture Hours	75	Total Marks	100
Year of Introduction:	Year of Offering: 2021 - 22	Year of Revision: ----	Percentage of Revision: 0%
CLASS:	I.B.COM., (gen)		

Course Objectives:

- This course aims at acquainting the students with emerging issues in business at the National and International level in the light of policies of liberalization and Globalization.
- evaluate the economic, social political and legal environment components in business decision making.

Course Outcomes:

CO1: Understand how an entity systematically explores the external environment in which business operates.

CO2: To enlighten/familiarize the impact of economic environment and its effect on government policies for development of business.

CO3: To acquire specialized knowledge relating to economic policies in India.

CO4: critically examine the economic, social political and legal environment components in business decision making.

CO5: synthesize multiple perspective to formulate responses to opportunities and institutions in international environment.

Syllabus
Business Environment

Unit	Learning Units	Lecture Hours
I	Overview of Business Environment: Business Environment – Meaning – Characteristics – Scope -Macro and Micro Dimensions of Business Environment -Environmental Analysis- Purpose & Techniques.	15
II	Economic Environment: Economic Environment – Nature of the Economy – Structure of Economy – Economic Policies & Planning the Economic Condition – NITI Ayog – National Development Council – Five Year Plans	15
III	Economic Policies: Economic Reforms and New Economic Policy – New Industrial Policy – Competition Law – Fiscal Policy – Objectives and Limitations – Monetary Policy and RBI	15
IV	Social, Political and Legal Environment: Concept of Social Responsibility of Business towards Stakeholders - Demonetization, GST and their Impact - Political Stability - Legal Changes.	15
V	Global Environment: Globalization – Meaning – Role of WTO – WTO Functions -IBRD– Trade Blocks, BRICS, SAARC, ASEAN in Globalization	15

Text book: . Rosy Joshi and Sangam Kapoor :Business Environment

Reference Books

1. K. Aswathappa : Essentials of Business Environment, Himalaya Publishing House
2. Francis Cherunilam : Business Environment, Himalaya Publishing House
3. Dr S Sankaran: : Business Environment, Margham Publications

Co-curricular activities

- ◆ Seminar on overview of business environment
- ◆ Debate on micro v/s macro dimensions of business environment
- ◆ Seminar on Monetary policies of RBI
- ◆ Debate on social, political and legal environment
- ◆ Group Discussions on Global environment and its impact on business
- ◆ To learn about NITI Ayog and National Development Council
- ◆ Seminars on Economic policies like New Industrial policy, Fiscal policy etc.
- ◆ Reports on WTO, BRICS, SAARC



A. G & S.G. SIDDHARTHA DEGREE COLLEGE OF ARTS & SCIENCE

Vuyyuru-521165.

NAAC recredited at 'A' level

Autonomous -ISO 9001 – 2015 Certified

Model Question Paper

Commerce	I B.Com (Gen)	Semester-I	COMT13
-----------------	----------------------	-------------------	---------------

Business Environment

Time: 3 Hours Max. Marks:70M

Answer the following

5 x14 = 70

Unit - I

1. A) -----10(MARKS)

B) -----4(MARKS)

(OR)

C) -----10(MARKS)

D) -----4(MARKS)

Unit – II

2. A) -----10(MARKS)

B) -----4(MARKS)

(OR)

C) -----10(MARKS)

D) -----4(MARKS)

Unit – III

3. A) -----10(MARKS)

B) -----4(MARKS)

(OR)

C) -----10(MARKS)

D) -----4(MARKS)

Unit – IV

4. A) -----10(MARKS)

B) -----4(MARKS)

(OR)

C) -----10(MARKS)

D) -----4(MARKS)

Unit - V

5. A) -----10(MARKS)

B) -----4(MARKS)

(OR)

C) -----10(MARKS)

D) -----4(MARKS)



A. G & S.G. SIDDHARTHA DEGREE COLLEGE OF ARTS & SCIENCE

Vuyyuru-521165.

NAAC reaccruited at 'A' level

Autonomous -ISO 9001 – 2015 Certified

TITLE OF THE PAPER: **INSURANCE PROMOTION**

Semester: I

Course Code	COMT15S	Course Delivery Method	Class Room / Blended Mode - Both
Credits	2	CIA Marks	15
No. of Lecture Hours / Week	2	Semester End Exam Marks	35
Total Number of Lecture Hours	30	Total Marks	50
Year of Introduction:	Year of Offering: 2021-22	Year of Revision: ----	Percentage of Revision: 0%
Class:	I.B.Com., (gen/comp/e-com)		

Learning Outcomes:

After successful completion of the course, students will be able to;

1. Understand the online business and its advantages and disadvantages
2. Recognize new channels of marketing, their scope and steps involved
3. Analyze the procurement, payment process, security and shipping in online business
4. Create new marketing tools for online business
5. Define search engine, payment gateways and SEO techniques.

Syllabus

INSURANCE PROMOTION

Unit	Learning Units	Lecture Hours
I	Introduction of Insurance - Types of insurances. Growth of Insurance sector in India - Regulatory mechanism (IRDA) - Its functions	10
II	Life Insurance plans. Health insurance plans. Products and features. Contents of documents- Sales Promotion methods - Finding prospective customers - Counselling - Helping customers in filing - Extending post-insurance service to customers	10
III	General Insurance - It's products (Motor, Marine, Machinery, Fire, Travel and Transportation) and features. Contents of documents. Dealing with customers - Explaining Products to Customers - Promoting Customer loyalty. Maintenance of Records.	10

Reference books:

1. Principles of Insurance, Himalaya publishing House
2. Principles and Practice of Insurance,
3. Fundamentals of insurance,
4. Life and General Insurance Management,
5. Financial services, Tata McGraw hill
6. Insurance Principles and Practices, Sultan Chand & Son

AG & SG SIDDHARTHA DEGREE COLLEGE OF ARTS & SCIENCE (AUTONOMOUS),

VUYYURU- 521 165

(MANAGED BY SIDDHARTHA ACADEMY OF GENERAL & TECHNICAL EDUCATION VIJAYAWADA)

Commerce	COMT15S	2022-2023	I.B.Com(Gen,Comp& e-com)
----------	---------	-----------	-----------------------------

SEMESTER –I

Model Paper

**INSURANCE PROMOTION
Skill Development Course**

Max. Time: 2 HOURS

SECTION – A

Max. Marks: 35

Answer any **THREE** of the following questions

3X5=15M

1. Define Insurance?
2. Explain about IRDA
3. What are the advantages of Health Insurance?
4. What is marine Insurance
5. What are the features of General insurance?
6. Explain post insurance services to customer

SECTION – B

Answer any **TWO** of the following questions

2x10=30M

9. Explain different types of Insurance?
10. What are the differences between General insurance and life insurance?
11. What are the differences between Endowment policies and Term policies?
12. What are the Types of General insurance?



A. G & S.G. SIDDHARTHA DEGREE COLLEGE OF ARTS & SCIENCE

Vuyyuru-521165.

NAAC recredited at 'A' level

Autonomous -ISO 9001 – 2015 Certified

TITLE OF THE PAPER: **Advanced Accounting**

Semester: III

Course Code	COMT37	Course Delivery Method	Class Room / Blended Mode - Both
Credits	4	CIA Marks	25
No. of Lecture Hours / Week	5	Semester End Exam Marks	75
Total Number of Lecture Hours	75	Total Marks	100
Year of Introduction:	Year of Offering: 2021 - 22	Year of Revision: 2022-23	Percentage of Revision: 5%
CLASS:	II.B.COM., (gen/computer/ e-commerce)		

Course Prerequisites (if any): Intermediate level

Course Description:

Course Objectives:

1. Learn the criteria for identifying Revenue Expenditure and distinguishing from Capital Expenditure and understand the linkage of such distinction with the preparation of Final Accounts.
2. Understand the special features of Instalment system and also analyses the distinction between the Hire Purchase System and Instalment System.
3. Understand the features of Partnership firm and the need for valuation of goodwill as well as revaluation of Assets and Liabilities.

Course Outcomes: At the end of this course, students should be able to:

CO1: Student will be able to understand different situations to calculate interest on various installments and understand need for re-possession and the procedure in case of default.-PO5

CO2- Student will be able to understand Profit & Non-profit concern and to ascertain the surplus/deficit relating to various non-trading concerns –PO6

CO3-Student will get the knowledge of partnership business, its accounts and modes of settlement in case of partnership restructuring.- PO7

CO4- Student will acquire the capacity to settle the accounts in case of dissolution by realization of various assets.-PO5

CO5- Student will obtain the knowledge of branch accounting procedure and the process of conversion of foreign branch transactions into Indian currency.-PO7

Syllabus

Unit	Learning Units	Lecture Hours
I	Accounting for Non Profit Organizations: Non Profit Entities- Meaning - Features of Non-Profit Entities –Provisions as per Sec 8 - Accounting Process- Preparation of Accounting Records - Receipts and Payments Account- Income and Expenditure Account - Preparation of Balance Sheet (including problems).	15
II	Single Entry System: Features – Differences between Single Entry and Double Entry – Disadvantages of Single Entry- Ascertainment of Profit and Preparation of Statement of Affairs (including Problems)- Conversion of Single entry to Double entry system (Simple Problems).	15
III	Hire Purchase System: Features –Difference between Hire Purchase and Instalment Purchase Systems - Accounting Treatment in the Books of Hire Purchaser and Hire Vendor - Default and Repossession (including Problems).	15
IV	Partnership Accounts-I: Meaning – Partnership Deed - Fixed and Fluctuating Capitals-Accounting Treatment of Goodwill - Admission and Retirement of a Partner (including problems).	15
V	Partnership Accounts-II: Dissolution of a Partnership Firm – Application of Garner v/s Murray Rule in India – Insolvency of one or more Partners (including problems).	15

Textbook:

1. S.P JAIN AND K.L NARANG, ADVANCED ACCOUNTANCY, KALYANI PUBLISHERS

Recommended Reference book:

1. SN Maheswari & SK Maheswari, Financial Accounting, Vikas Publications.
2. R.L. Gupta & V.K. Gupta, Principles and Practice of Accounting, Sultan Chand & Sons.
3. S.N. Maheshwari & V.L. Maheswari, Advanced Accountancy (Vol-II), Vikas publishers.
4. S.P. Jain & K.L. Narang, Accountancy–III, Kalyani Publishers.

Course Delivery method: Face-to-face / Blended

Course has focus on: Employability

Websites of Interest:

Co-curricular Activities:

- Quiz Programs
- Co-operative learning
- Seminar
- Visit a single-entry firm, collect data and Creation of Trial Balance of the firm
- Visit Non-profit organization and collect financial statements
- Critical analysis of rate of interest on hire purchase schemes
- Visit a partnership firm and collect partnership deed
- Debate on Garner v/s Murray rule in India and outside India
- Group Discussions on problems relating to topics covered by syllabus
- Examinations (Scheduled and surprise tests) on all units

Revision of the syllabus 2022-23 (SEM -1,3,5)

Name of the Subject: **Advanced Accounting**

Subject Code: COMT31A

Academic Year	2022-23
Title of the paper	Advanced Accounting
Semester	III
Course code	COMT31A
CIA marks	25
Semester End marks	75
Total marks	100
Year of Introduction	2021-22
Year of Revision	2022-23
% of revision	5%

UNIT	Syllabus	Addition	Deletion
I	Accounting for Non Profit Organizations: Non Profit Entities- Meaning - Features of Non-Profit Entities – Provisions as per Sec 8 - Accounting Process-Preparation of Accounting Records - Receipts and Payments Account- Income and Expenditure Account - Preparation of Balance Sheet (including problems).	Nil	Nil
II	Single Entry System: Features – Differences between Single Entry and Double Entry – Disadvantages of Single Entry- Ascertainment of Profit and Preparation of Statement of Affairs (including Problems)- Conversion of Single entry to Double entry system (Simple Problems).	Conversion of Single entry to Double entry system (Simple Problems).	Nil
III	Hire Purchase System: Features –Difference between Hire Purchase and Installment Purchase Systems - Accounting Treatment in the Books of Hire Purchaser and Hire Vendor - Default and Repossession (including Problems).	Nil	Nil
IV	Partnership Accounts-I: Meaning – Partnership Deed - Fixed and Fluctuating Capitals-Accounting Treatment of Goodwill - Admission and Retirement of a Partner (including problems).	Nil	Nil
V	Partnership Accounts-II: Dissolution of a Partnership Firm – Application of Garner v/s Murray Rule in India – Insolvency of one or more Partners (including problems).	Nil	Nil



A. G & S.G. SIDDHARTHA DEGREE COLLEGE OF ARTS & SCIENCE

Vuyyuru-521165.

NAAC recredited at 'A' level

Autonomous -ISO 9001 – 2015 Certified

Model Question Paper Advanced Accounting

Commerce	II B.Com (Gen, CA&e-Com)	Semester-III	COMT37
----------	--------------------------	--------------	--------

Max.:75 Marks

Min. Pass: 30 Marks

Section - A

Answer any Five of the following

5 x 5 = 25 Marks

1. Explain Donations. (CO1, L1)
2. Write about Legacies. (CO1, L1)
3. Briefly explain about Accounting from Incomplete Records. (CO2, L1)
4. What is meant by Repossession of Goods? (CO3, L1)
5. Define Installment Purchase System. (CO3, L1)
6. What are Fixed and Fluctuating Capital Methods. (CO4, L1)
7. Explain the Goodwill treatment in case of Admission of a new partner. (CO4, L1)
8. What is Insolvency of partner. (CO5, L1)

Section - B

Answer the following questions

(5 x 10 = 50 Marks)

Unit I

9. (a) What are the differences between Receipts and Payments Account and Income and Expenditure Account? (CO1, L2)

(Or)

(b) The following is the Receipts and Payments account of a Hospital for the year ended 31st December, 2015, prepare Income and Expenditure account and a Balance sheet as at the date: (CO1, L3)

Receipts and Payments Account for the year ended 31st December 2015

Receipts	Amount	Payments	Amount
To Cash in hand	3,565	By Medicines	15,295
To Subscriptions	23,998	By Doctors honorarium	4,500
To Donations	7,250	By Salaries	13,750
To Interest on investments @7%	3,500	By Petty expenses	230
To Proceeds from charity	5,225	By Equipment	7,500
		By Expenses on charity show	375
		By Cash in hand	1,888
	43,538		43,538

Additional information:

	1.1.2015	31.12.2015
a. Subscriptions due	120	140
b. Subscriptions received in advance	32	55
c. Stock of medicines	4,405	4,870
d. Estimated value of equipment	10,600	15,800
e. Buildings (Cost less depreciation)	20,000	19,000

Unit II

10. (a) What is Single Entry System? What are the features of Single Entry System? (CO1, L1)
(Or)
(b) From the following details, prepare Trading, Profit and Loss Account and Balance Sheet.

Particulars	On 31.3.2019	On 31.3.2020
Stock	25,000	12,500
Debtors	62,500	87,500
Cash	6,250	10,000
Furniture	2,500	2,500
Creditors	37,500	43,750

Bad debts Rs.1,250; Discount received Rs.3,750; Discount allowed Rs.2,500; Sundry expenses Rs.7,500; Payments to creditors Rs.1,12,500; Received from Debtors Rs.1,33,750; Drawings Rs.10,000; Sales returns Rs.3,750; Purchases returns Rs.1,250. Charge depreciation on furniture @ 5% p.a. (CO2, L3)

Unit III

11. (a) What is Hire Purchase System? Explain the features of Hire Purchase System. (CO3, L1)
(Or)
(b) The Madras Transport Company purchased motor car from the Bombay Motor Co. on hire purchase agreement on 1st January 2013, paying cash Rs.10,000 as down payment and agreeing to pay further three instalments of Rs.10,000 each on 31st December each year. The cash price of the car is Rs.37,250 and the Bombay Motor Company charges interest as depreciation on the reducing instalment system. Prepare necessary accounts in the books of Madras Transport Company. (CO3, L2)

Unit IV

12. (a) What is a Partnership Deed? What are the contents in Partnership Deed? (CO4, L1)
(Or)
(b) The following is the Balance Sheet of Harshitha and Sindhu who had been sharing profit and losses in the ratio of 3:2. (CO4, L3)

Liabilities	Amount	Assets	Amount
Creditors	20,000	Cash	3,000
General Reserve	15,000	Bank	7,000
Bills Payable	5,000	Debtors	10,000
Capital Accounts		Furniture	20,000
Harshitha	40,000	Machinery	25,000
Sindhu	20,000	Buildings	35,000
	1,00,000		1,00,000

They agreed to take Sravani as a partner on the following conditions:

- Sravani pay Rs.10,000 as her capital for 1/4th share in the future profits.
- Provision for doubtful debts to be created on debtors 10%.
- Depreciation on furniture 5%, on machinery 10%.
- Increase value of building by 20%.
- Goodwill to be valued Rs.75,000.

Prepare necessary ledger accounts and balance sheet after entry of new partner.

Unit V

13. (a) Briefly explain the rule in **Garner v/s Murray** case. **(CO5, L2)**

(Or)

(b) The following is the Balance Sheet of P Q and R on 31st December 2020, the partners sharing profits in the ratio of 5 : 3 : 2. **(CO5, L4)**

Balance Sheet of P,Q & R as at 31st December 2005					
Liabilities		Rs.	Assets		Rs.
Creditors		30,000	Cash at Bank		6,000
Bills Payable		7,000	Sundry Debtors	20,000	
Loan from P		30,000	Less Provision for		
General Reserve		15,000	doubtful debts	1,000	19,000
Capital Accounts:			Stock		30,000
P	30,000		Investments		10,000
Q	25,000		Fixtures		2,000
R	15,000	70,000	Plant		35,000
			Freehold Property		50,000
		1,52,000			1,52,000

The Partnership was dissolved, and the assets realised the following amounts:

Stock and investments realised 10 percent less than the book values. Debtors realised Rs.17,500 and Plant Rs.30,000. Freehold property was sold for Rs.85, 000. Fixtures were taken over by P at an agreed value of Rs.1, 200. Creditors were paid off at a discount of 5 percent. Q agreed to pay the bills payable. Expenses of realisation amounted to Rs.1, 000.

Pass Journal entries to give effect to the above and show the necessary ledger accounts.



A. G & S.G. SIDDHARTHA DEGREE COLLEGE OF ARTS & SCIENCE

Vuyyuru-521165.

NAAC reaccredited at 'A' level

Autonomous -ISO 9001 – 2015 Certified

TITLE OF THE PAPER: Business Statistics

Semester: III

Course Code	COMT32	Course Delivery Method	Class Room / Blended Mode - Both
Credits	4	CIA Marks	25
No. of Lecture Hours / Week	5	Semester End Exam Marks	75
Total Number of Lecture Hours	75	Total Marks	100
Year of Introduction:	Year of Offering: 2012 - 13	Year of Revision: 2021-22	Percentage of Revision: 25%
CLASS:	II.B.COM., (gen/computer)		

Course Prerequisites (if any): Intermediate level

After completing this programme the students will be able to –

Objective: 1. The objective of this course is to impart knowledge on the application of statistical tool and techniques in business decision making.

2. Students will be able to understand basic theoretical and applied principles of statistics.

3. Students will gain proficiency in using statistical for data analysis.

CO-1 Students will be able to understand the basic knowledge and characteristics of business statistics. PO5, PO7

CO-2 Determine the value of the mean, the median, and the mode of ungrouped data. PO5, PO7

CO-3 Explains the disparity of data from one another delivering a precise view of the distribution of data. PO5, PO7

CO-4 Design, Evaluate and apply regression analysis. PO5, PO7

CO-5 Students will be able to understand interpret indexes to identify trends in a data set. And what the trend, seasonality, cyclical irregularity in time series. PO5, PO7

Syllabus

Unit	Learning Units	Lecture Hours
I	Introduction to Statistics: Definition, Importance and limitation of statistics, Collection of data, Schedule and questionnaire, Frequency distribution, Tabulation	12
II	Measures of Central Tendency: Characteristics of measures of central tendency, Types of Averages, Arithmetic Mean, Geometric Mean, Harmonic Mean, Median, Mode	18
III	Measures of dispersion and Skewness: Properties of dispersion, Range, Quartile Deviation, Mean deviation, Standard deviation, Coefficient of Variation, Skewness Definition, Karl Pearson's and Bowley's Measures Of skewness	15
IV	Measures of Relation: Meaning and use of correlation, Types of correlation, Karl Pearson's correlation coefficient, Probable Error, Spearman's Rank correlation, Regression analysis comparison between correlation and Regression, Regression Equations	15
V	Analysis of Time Series & Index Numbers Meaning and utility of time series, Components of Time series, Measurement of trend and Seasonal Variations, Techniques of Time series analysis, Methods of averages(Semi , Moving averages), Least square method, Index Numbers, Methods of Construction of Index numbers, Price index numbers, Limitations of index numbers.	15

Text Book

- 1) Business Statistics –S.Chand

Reference Books:

- 1) Business Statistics – S. L Agarwal , S. L Bhrdwaj, K. Raghuvver – Kalyani publishers
- 2) Business Statistics And Operations Research – Dr. S.P .Gupta, P.K. Gupta, Dr.Manmohan – S. Chand

Suggested Co-Curricular Activities:

1. Power point presentations
2. Role play
3. Seminar
4. Problem Solving Exercises

Quiz using Google forms

Revision of the syllabus 2022-23 (SEM -1,3,5)

Name of the Subject: **Business Statistics**

Subject Code: COMT32

Academic Year	2022-23
Title of the paper	Business Statistics
Semester	III
Course code	COMT32
CIA marks	25
Semester End marks	75
Total marks	100
Year of Introduction	2012-13
Year of Revision	2021-22
% of revision	25%

UNIT	Syllabus	Addition	Deletion
I	Introduction to Statistics: Definition, Importance and limitation of statistics, Collection of data, Schedule and questionnaire, Frequency distribution, Tabulation	Nil	Diagrams and Graphic Presentation of Data (including problems)
II	Measures of Central Tendency: Characteristics of measures of central tendency, Types of Averages, Arithmetic Mean, Geometric Mean, Harmonic Mean, Median, Mode	Nil	Nil
III	Measures of dispersion and Skewness: Properties of dispersion, Range, Quartile Deviation, Mean deviation, Standard deviation, Coefficient of Variation, Skewness Definition, Karl Pearson's and Bowley's Measures Of skewness	Skewness Measures of Skewness: Absolute and Relative Measures- Coefficient of Skewness: Karl Pearson's, Bowley's	Kurtosis: Meso kurtosis, Platy kurtosis and Leptokurtosis (including problems)
IV	Measures of Relation: Meaning and use of correlation, Types of correlation, Karl Pearson's correlation coefficient, Probable Error, Spearman's Rank correlation, Regression analysis comparison between correlation and Regression, Regression Equations	Nil	Nil

V	<p>Analysis of Time Series & Index Numbers Meaning and utility of time series, Components of Time series, Measurement of trend and Seasonal Variations, Techniques of Time series analysis, Methods of averages(Semi , Moving averages), Least square method, Index Numbers, Methods of Construction of Index numbers, Price index numbers, Limitations of index numbers.</p>	<p>Analysis of Time Series & Index Numbers Meaning and utility of time series, Components of Time series, Measurement of trend and Seasonal Variations, Techniques of Time series analysis, Methods of averages(Semi , Moving averages), Least square method, Index Numbers, Methods of Construction of Index numbers, Price index numbers, Limitations of index numbers.</p>	Nil
---	---	--	-----



A. G & S.G. SIDDHARTHA DEGREE COLLEGE OF ARTS & SCIENCE

Vuyyuru-521165.

NAAC reaccruited at 'A' level
Autonomous -ISO 9001 – 2015 Certified

MODEL QUESTION PAPER

Commerce	II B.Com (Gen, CA)	Semester-III	COMT32
----------	--------------------	--------------	--------

Business Statistics

Time: 3Hrs

Max.Marks:75

Section – A

Answer any **FIVE** of the following

5 x 5 = 25 Marks

1. Mention four important functions of statistics. **CO1,L1**
2. What are different kinds of classifications? **CO1,L1**
3. What are different types of averages? **CO2,L1**
4. Define standard deviation and its coefficient. **CO3,L1**
5. Explain different types of correlation. **CO4,L2**
6. State seasonal variations and explain any three uses? **CO5,L3**
7. What are the different types of price index numbers? **CO5,L1**
8. What are the methods of construction of index numbers? **CO5,L1**

Section – B

Answer **All** the questions

5 x 10 = 50 Marks

9. (a) Contrast between primary and secondary data. **CO1,L2**
OR
(b) What is a questionnaire? Discuss the precautions to be taken while preparing a questionnaire. **CO1,L1**
10. (a) What is an average? What are characteristics of a good average? **CO2, L1**
OR
(b) Calculate a Mean and Mode from the data given below: **CO2,L3**

Wages	10 – 15	15 – 20	20 – 25	25 – 30	30 – 35	35 – 40	40 – 45	45 – 50
No. of Workers	22	45	67	73	85	90	64	55

11. (a) What are the objects or uses of Dispersion? **CO3,L1**
OR
(b) Compute, S.D and Co – efficient of variation for given data **CO3,L3**

x	0 – 10	10 – 20	20 – 30	30 – 40	40 – 50
f	5	15	30	65	80

12. (a) Distinguish between correlation and regression analysis. **CO4,L4**
OR

(b) The following are the ranks assigned by 2 judges A & B to 12 contestants in cooking competition. Find out what agreement the judges had in judgment. **CO4, L4**

S. No	A	B	C	D	E	F	G	H	I	J	K	L
A	1	9	2	10	3	11	8	4	12	9	5	6
B	2	9	1	7	4	10	8	3	12	6	5	11

13. (a) What do you mean by an index numbers? Explain its uses and limitations. **CO5, L1**

OR

(b) Following are the data of production of computers in a factory. Fit a straight line trend. **CO5, L4**

Year	2000	2001	2002	2003	2004
Production (in Lakhs)	4	6	9	10	11



A. G & S.G. SIDDHARTHA DEGREE COLLEGE OF ARTS & SCIENCE

Vuyyuru-521165.

NAAC reaccredited at 'A' level

Autonomous -ISO 9001 – 2015 Certified

TITLE OF THE PAPER: Marketing
Semester: III

Course Code	COMT33	Course Delivery Method	Class Room / Blended Mode - Both
Credits	4	CIA Marks	25
No. of Lecture Hours / Week	5	Semester End Exam Marks	75
Total Number of Lecture Hours	75	Total Marks	100
Year of Introduction:	Year of Offering: 2021 - 22	Year of Revision: ----	Percentage of Revision: 0%
CLASS:	II.B.COM.,(gen)		

CourseObjective:

- 1.To acquire knowledge on marketing concepts, 4P's, to build applicable skills through variety internship opportunities
2. Student will gain understanding of consumer buyer behavior, pricing strategies and ethical concept of marketing

Learning Outcomes:

- CO1: To introduce the concepts of marketing and understand the factors influence the market environment.
- CO2: Analyze the consumer market models and enlightens consumer buyer behavior models.
- CO3: Understand the concept of product and identify the need of product mix and product line decisions.
- CO4: Develop an idea about pricing strategies and pricing decisions.
- CO5: Enhance the students about decisions regarding promotion and distribution channels.

SYLLABUS

Marketing

Course Details

Unit	Learning Units	Lecture Hours
I	Introduction: Concepts of Marketing: Need, Wants and Demand - Marketing Concepts – Marketing Mix - 4 P's of Marketing – Marketing Environment.	15
II	Consumer Behavior and Market Segmentation: Buying Decision Process – Stages – Buying Behavior – Market Segmentation –Bases of Segmentation - Selecting Segments – Advantages of Segmentation	15
III	Product Management: Product Classification – Levels of Product - Product Life Cycle - New Products, Product Mix and Product Line Decisions - Design, Branding, Packaging and Labelling.	15
IV	Pricing Decision: Factors Influencing Price – Determination of Price - Pricing Strategies: Skimming and Penetration Pricing.	15
V	Promotion and Distribution: Promotion Mix - Advertising - Sales promotion - Publicity – Public Relations - Personal Selling and Direct Marketing - Distribution Channels – Online Marketing	15

References:

1. Philip Kotler, Marketing Management, Prentice Hall of India.
2. Philip Kotler & Gary Armstrong, Principles of Marketing, Pearson Prentice
3. Stanton J. William & Charles Futrell Fundamentals of Marketing, McGraw Hill Company



A. G & S.G. SIDDHARTHA DEGREE COLLEGE OF ARTS & SCIENCE
Vuyyuru-521165.
NAAC recredited at 'A' level
Autonomous -ISO 9001 – 2015 Certified

<i>Commerce</i>	<i>II B.Com (Gen.)</i>	<i>Semester-III</i>	<i>COMT33</i>
-----------------	------------------------	---------------------	---------------

Marketing

Semester: III

Model paper

Time: 3 hrs

Max. Marks: 75

SECTION- A

I. Answer any Five of the following questions

5x 5= 25M

1. Selling Concept
2. What is Consumer behavior
3. What is New Product
4. Online Marketing
5. Advantages of skimming pricing
6. Define Marketing Environment
7. Define Branding
8. Advantages of Direct Marketing

SECTION- B

II. Answer the following questions

5 x 10 = 60M

- 9.(a). Describe 4P's of Marketing
(Or)
(b) What are the Different Concepts of Marketing
- 10.(a). What is Market Segmentation?
(Or)
(b) Describe the stages in Buying Decision process
11. (a). Describe Product Life Cycle.
(Or)
(b) Advantages and disadvantages Packaging and labeling
12. (a). Explain the different types of Pricing strategies
(Or)
(b) What are the Factor Influencing Price Determination
13. (a). What are the differences Between Personal selling and Direct Marketing?
(Or)
(b) Types of Distribution channels



A. G & S.G. SIDDHARTHA DEGREE COLLEGE OF ARTS & SCIENCE

Vuyyuru-521165.
NAAC reaccruited at 'A' level
Autonomous -ISO 9001 – 2015 Certified

TITLE OF THE PAPER: E COMMERCE

Semester: III

Course Code	COMT34	Course Delivery Method	Class Room / Blended Mode - Both
Credits	4	CIA Marks	25
No. of Lecture Hours / Week	5	Semester End Exam Marks	75
Total Number of Lecture Hours	75	Total Marks	100
Year of Introduction:	Year of Offering:	Year of Revision: ----	Percentage of Revision: 0%
CLASS:	I.B.COM., (E-commerce)		

Course outcomes :

- CO1: Students understand the mechanism of E- commerce (PO5) (PSO1)
- CO2: Students themselves equip specialization in website designing for E-Commerce (PO5) (PSO1)
- CO3: Students are able to enhance their skills in operational services of E-Commerce (PO5) (PSO1)
- CO4: Students are able to involve in activities of E-Commerce (PO5) (PSO1)
- CO5: Students are able to create awareness among the public one commerce activities (PO5) (PSO1)

Syllabus

Unit	Learning Units	Lecture Hours
I	Introduction, Nature and Scope Introduction- Definition –importance- Nature and scope of e commerce-Advantages and limitations-Types of ecommerce– B2B,B2C,C2B,C2C,B2A,C2A-Frameworkecommerce	15
II	Environmental and Technical support Aspects Technical Components-Internet and its component structure- Internet Vs Intranet, Vs Extranet and their differences-Website design- its structure-designing, developing and deploying the system-	15
III	Security and Legal Aspects Security environment –its preliminaries and precautions-protecting Web server with Firewalls-Importance of Digital Signature –its components – Cyber Law-Relevant Provisions of IT Act2000.	15
IV	Operational Services of e Commerce E retailing –features- E Services-Banking, Insurance, Travel, Auctions, Learning, Publication and Entertainment-Payment of utilities (Gas, Current Bill, Petrol Products)- On Line Shopping (Amazon,Flip kart, Snapdeal etc.)	15
V	E payment System Types of e payment system- its features-Digital payments (Debit Card/Credit Cards, Internet Banking, Mobile wallets- Digital Apps (unified Payment Services-Phone Pay, Google Pay, BHIMEtc.)UnstructuredSupplementaryServicesData(BankPrepaidCard, Mobilebanking)-	15

Text Books:

1. Bharat Bhaskar , Electronic Commerce Framework, Technology and Application.McGrawHillEducation

References:

1. Bajaj,D.Nag,ECommerce, TataMcGrawHillPublication
2. WhitelyDavid , E-Commerce,McGrawHill
3. TNChhabra,ECommerce,DhanapatRai&Co
4. DaveChaffey,EBusinessandECommerceManagement,PearsonPublication
- 5.Dr.PratikKumarPrajapati,Dr.M.Patel,ECommerce,RedshinePublication

A. G & S.G. SIDDHARTHA DEGREE COLLEGE OF ARTS & SCIENCE



Vuyyuru-521165.
NAAC reaccredited at 'A' level
Autonomous -ISO 9001 – 2015 Certified

E- COMMERCE

Time: 3Hrs

Max Marls: 75

Commerce	II B.Com (e-com)	Semester-III	COMT34
-----------------	-------------------------	---------------------	---------------

Section –A

Answer any Five of the following

5X5=25M

1. Define E commerce. (CO1)
2. Write about B2B. (CO1)
3. Write about Internet (CO2)
4. Write about Digital signature (CO3)
5. E-Banking services (CO4)
6. Auctions (CO4)
7. Write about Digital Payments (CO5)
8. Mobile Wallets (CO5)

Section –B

Answer the following questions.

5X10=50M

9. a) Describe the importance and scope of E Commerce (CO1)

OR

- b) Explain the types of E Commerce (CO1)

10. a) Explain Different Technical Components in E Commerce (CO2)

OR

- b) How do you design a Web sites (CO2)

11. a).Write about security environment (CO3)

OR

- b) Describe about Cyber law. (CO3)

12. a) Explain the features of E retailing (CO4)

OR

- b) Explain different payments utilities of Online shopping (CO4)

13. a) Explain different types of E payment system (CO5)

OR

- b) Explain unstructured Supplementary service data.(CO5)



A. G & S.G. SIDDHARTHA DEGREE COLLEGE OF ARTS & SCIENCE

Vuyyuru-521165.

NAAC reaccruited at 'A' level

Autonomous -ISO 9001 – 2015 Certified

TITLE OF THE PAPER: **ONLINE BUSINESS**

Semester: III

Course Code	COMT 35S	Course Delivery Method	Class Room / Blended Mode - Both
Credits	2	CIA Marks	10
No. of Lecture Hours / Week	2	Semester End Exam Marks	40
Total Number of Lecture Hours	30	Total Marks	50
Year of Introduction:	Year of Offering: 2021- 22	Year of Revision: ----	Percentage of Revision: 0%
Class:	II. B.Com., (gen/comp/e-com)		

Learning Outcomes:

After successful completion of the course, students will be able to;

1. Understand the online business and its advantages and disadvantages
2. Recognize new channels of marketing, their scope and steps involved
3. Analyze the procurement, payment process, security and shipping in online business
4. Create new marketing tools for online business
5. Define search engine, payment gateways and SEO techniques.

Syllabus
ONLINE BUSINESS

Unit	Learning Units	Lecture Hours
I	Introduction to Online-Business-Definition-Characteristics-Advantages of Online Business-Challenges- Differences between off-line business, e-commerce and Online Business.	10
II	Online-business Strategies-Strategic Planning Process-Procurement -Logistics & Supply Chain Management- Customer Relationship management.	10
III	Designing Online Business Website – Policies - Security & Legal Issues - Online Advertisements - Payment Gateways - Case Study	10

Co-curricular Activities Suggested: (4 hrs)

1. Assignments, Group discussion, Quiz etc.
2. Short practical training in computer lab
3. Identifying online business firms through internet
4. Invited Lectures by e-commerce operators
5. Working with Google and HTML advertisements.
6. Visit to a local online business firm.



A. G & S.G. SIDDHARTHA DEGREE COLLEGE OF ARTS & SCIENCE

Vuyyuru-521165.

NAAC recredited at 'A' level

Autonomous -ISO 9001 – 2015 Certified

TITLE OF THE PAPER: ONLINE BUSINESS

Commerce	II B.Com (Gen, CA &e-Com)	Semester-III	COMT 35S
-----------------	--------------------------------------	---------------------	-----------------

MODEL PAPER

DURATION: 2 HOURS

Max marks : 40

SECTION – A

Answer any TWO of the following **2x5=10M**

1. Define Online Business
2. Online Business strategies
3. Supply Chain Management
4. Legal issues of Online Business

SECTION – B

Answer any THREE of the following

3x10=30M

5. Explain the Advantages of Online Business?
6. What are the differences between Offline and Online Business?
7. Explain about Online Business Strategic planning process
8. Describe Online Business Strategic Planning process
9. How do you Design Online Business Website
10. Describe the Polices of Online Business



A. G & S.G. SIDDHARTHA DEGREE COLLEGE OF ARTS & SCIENCE

Vuyyuru-521165.

NAAC reaccruited at 'A' level

Autonomous -ISO 9001 – 2015 Certified

TITLE OF THE PAPER: **INSURANCE PROMOTION**

Semester: III

Course Code	COMT36S	Course Delivery Method	Class Room / Blended Mode - Both
Credits	2	CIA Marks	10
No. of Lecture Hours / Week	2	Semester End Exam Marks	40
Total Number of Lecture Hours	30	Total Marks	50
Year of Introduction:	Year of Offering: 2021-22	Year of Revision: ----	Percentage of Revision: 0%
Class:	II.B.Com., (gen/comp/e-com)		

Learning Outcomes:

After successful completion of the course, students will be able to;

1. Understand the online business and its advantages and disadvantages
2. Recognize new channels of marketing, their scope and steps involved
3. Analyze the procurement, payment process, security and shipping in online business
4. Create new marketing tools for online business
5. Define search engine, payment gateways and SEO techniques.

Syllabus

INSURANCE PROMOTION

Unit	Learning Units	Lecture Hours
I	Introduction of Insurance - Types of insurances. Growth of Insurance sector in India - Regulatory mechanism (IRDA) - Its functions	10
II	Life Insurance plans. Health insurance plans. Products and features. Contents of documents– Sales Promotion methods - Finding prospective customers – Counseling – Helping customers in filing - Extending post-insurance service to customers	10
III	General Insurance - It's products (Motor, Marine, Machinery, Fire, Travel and Transportation) and features. Contents of documents. Dealing with customers – Explaining Products to Customers - Promoting Customer loyalty. Maintenance of Records.	10

Reference books:

1. Principles of Insurance, Himalaya publishing House
2. Principles and Practice of Insurance,
3. Fundamentals of insurance,
4. Life and General Insurance Management,
5. Financial services, Tata McGraw hill
6. Insurance Principles and Practices, Sultan Chand & Son

AG & SG SIDDHARTHA DEGREE COLLEGE OF ARTS & SCIENCE (AUTONOMOUS),

VUYYURU- 521 165

(MANAGED BY SIDDHARTHA ACADEMY OF GENERAL & TECHNICAL EDUCATION VIJAYAWADA)

Commerce	COMT36S	2022-2023	I.B.Com(Gen,Comp& e-com)
----------	---------	-----------	-----------------------------

SEMESTER –I

Model Paper

**INSURANCE PROMOTION
Skill Development Course**

Max. Time: 2 HOURS

SECTION – A

Max. Marks: 40

Answer any **TWO** of the following questions

2x5=10M

1. Define Insurance?
2. Explain about IRDA
3. What are the advantages of Health Insurance?
4. What is marine Insurance

SECTION – B

Answer any **THREE** of the following questions

3x10=30M

9. Explain different types of Insurance?
10. What are the differences between General insurance and life insurance?
11. What are the differences between Endowment policies and Term policies?
12. Explain post insurance services to customer.
13. What are the features of General insurance?
14. Explain different types of General insurance.



A. G & S.G. SIDDHARTHA DEGREE COLLEGE OF ARTS & SCIENCE

Vuyyuru-521165.

NAAC recredited at 'A' level

Autonomous -ISO 9001 – 2015 Certified

TITLE OF THE PAPER: Advanced Corporate Accounting

Semester: V / VI

Course Code	CACA-501 G/C	Course Delivery Method	Class Room / Blended Mode - Both
Credits	4	CIA Marks	30
No. of Lecture Hours / Week	5	Semester End Exam Marks	70
Total Number of Lecture Hours	75	Total Marks	100
Year of Introduction:	Year of Offering: 2021 - 22	Year of Revision: ----	Percentage of Revision: 0%
CLASS:	III.B.COM., (gen/computer)		

CO1: The students are able to calculate purchase consideration and different methods of determining purchase consideration and its accounting treatment. (PO1) (PSO1)

CO2: students will acquire the knowledge on provisions for amalgamation of company as per accounting standard 14 and its treatment.(PO4) (PSO1)

CO3: The students will get the knowledge on forms of internal reconstruction and alteration and reduction of share capital and its accounting treatment.(PO4) (PSO1)

CO4:The students will be able to prepare consolidated financial statements and calculate minority interest and its accounting treatment.(PO4) (PSO1)

CO5: students will be able to prepare liquidators final statement of accounts at the time of winding up of a company. and are able to calculate liquidators remuneration and acquire the capacity for preparation of statement of affairs and deficiency account and its accounting treatment.(PO8) (PSO1)

Learning Objective:

1. This course will enable the students to combine practice and theoretical knowledge of financial accounting.
2. The students of this course will be active learners and develop awareness of emerging trends in financial accounting,
3. The course will provide decision making skills to the students in the financial analysis context,
4. The students of this course will have the ability to identify and analyze financial accounting problems and opportunities in real life situations.



A. G & S.G. SIDDHARTHA DEGREE COLLEGE OF ARTS & SCIENCE

Vuyyuru-521165.

NAAC recredited at 'A' level
Autonomous -ISO 9001 – 2015 Certified

Syllabus

ADVANCED CORPORATE ACCOUNTING

Paper code: CACA-501 G/C

Unit	Learning Units	Lecture Hours
I	Purchase of Business Meaning - Purchase Consideration - Methods for determining Purchase Consideration-Discharge of Purchase Consideration-Accounting Treatment.	15
II	Amalgamation of Companies Meaning and Objectives - Provisions for Amalgamation of Companies as per Accounting Standard 14 - Accounting Treatment.	15
III	Internal Reconstruction of Companies Meaning - Forms of Internal Reconstruction - Alteration of Share Capital and Reduction of Share Capital- Accounting Treatment.	15
IV	Accounts of Holding Companies Meaning of Holding Companies and Subsidiary companies- Consolidated Financial Statements- Legal requirements on Consolidation-Calculation of Minority Interest- Accounting Treatment.	15
V	Liquidation Meaning - Modes of Winding up of a Company- - Liquidator's Final Statement of Account - Calculation of Liquidator's Remuneration - Preparation of Statement of Affairs and Deficiency Account- Accounting Treatment	15

References:

1. Goyal, Bhushan Kumar. Corporate Accounting. Taxmann, New Delhi
2. Kumar, Alok. Corporate Accounting. Kitab Mahal
3. Monga, J. R. Fundamentals of Corporate Accounting. Mayur Paper Backs, New Delhi
4. Sah, Raj Kumar, Concept Building Approach to Corporate Accounting, Cengage
5. Sehgal Ashok & Sehgal Deepak. Corporate Accounting
6. Tulsian P. C. Corporate Accounting. S Chand & Co. New Delhi
7. <https://thebookee.net/ad/advanced-corporate-accounting-and-accounting-standards>
8. Web resources suggested by the Teacher concerned and the College Librarian including reading material



A.G & S.G.SIDDHARTHA DEGREE COLLEGE OF ARTS & SCIENCE

Vuyyuru-521165.

NAAC recredited at 'A' level

Autonomous -ISO 9001 – 2015 Certified

TITLE OF THE PAPER: Advanced Corporate Accounting

Commerce	B.Com (Gen/Comp)	Semester-V / VI	2022-2023	CACA -501 G/C
----------	------------------	-----------------	-----------	---------------

MODAL PAPER

Time: 3Hrs

Max Marls: 70

Section –A

Answer any TWO of the following

2x5=10M

1. Define Purchase consideration (CO1)
2. What is Amalgamation? (CO2)
3. What is internal reconstruction (CO3)
4. How do calculate Minority interest (CO4)

Section –B

Answer any FOUR of the following

4x15=60M

5. Explain the methods for determining the purchase consideration (CO1)
6. Explain the provisions for amalgamation of companies(CO2)
7. The following is the Balance Sheet of Moon Company Ltd on 31-3-2018. (CO2)

Liabilities	Rs.	Assets	Rs.
Capital		Land and buildings	1,20,000
20,000 shares of Rs.10 each	2,00,000	Plant & machinery	1,50,000
5% debentures	1,00,000	Work in progress	30,000
Creditors	30,000	Stock	60,000
Reserve fund	25,000	Furniture and fittings	2,500
Dividend equalization fund	20,000	Debtors	25,000
Profit & loss appropriation account	5,100	Cash at bank	12,500
Provision for depreciation on land and buildings	20,000	Cash in hand	100
	4,00,100		4,00,100

The company is amalgamated in the nature of purchase of sun company Ltd. On the above data the consideration for amalgamation the company is taking over the debentures trade liability and a payment of Rs.7 in cash and one share of the face value of Rs.5 in sun company Ltd. (market value Rs.8 per share in exchange for one share in moon company Ltd the cost of liquidation Rs.500 is to be met by the purchasing company you are required to pass journal entries in the books of both the companies and show purchase consideration is arrived at.

8. Following is the Balance sheet of X ltd as on 31-03-2019

(CO3)

Liabilities	Amount(RS)	Assets	Amount(RS)
5000 Equity shares of Rs 100 each	5,00,000	Goodwill	60,000
3000 8% preferences shares of Rs 100 each	3,00,000	Land & Buildings	2,50,000
6% Debentures	1,50,000	Plant & Machinery	1,00,000
Sundry creditors	1,95,000	Patents	60,000
		Stock	90,000
		Debtors	2,40,000
		Cash in hand	5,000
		Preliminary expenses	25,000
		Discount on issue of debenture	15,000
		Profit & Loss a/c	3,00,000
Totals	11,45,000		11,45,000

The following scheme of Reconstruction was duly approved

- i) Equity share are to be reduced to an equal number of fully paid shares of Rs 50 each
- ii) 8% Preference share are to be reduced by 40% and the rate of dividend increased to 9%
- iii) Value of Land & Buildings to be increased by 20%
- iv) Debentures are to be reduced by 20%
- v) All nominal and fictitious assets are to be eliminated and the balance used to write off patents
- vi) Further equity shares are to be issued for Rs 1,00,000 for each

9. Explain the legal requirements for consolidation(CO4)

10. H Ltd acquired all the share of S ltd on 1-1-2020 and liabilities and assets of the two companies on

31-03-2020 were as follows

(CO4)

	H Ltd	S Ltd
I Equity and Liabilities		
1) Shareholders funds		
a) Share capital:	8,00,000	3,00,000
shares of Rs 10 each		
b) Reserves and Surplus:		
i) Reserve on 1-4-2014	2,10,000	40,000
ii) Surplus a/c	50,000	30,000
2) Current Liabilities		
i) Creditors	3,50,000	1,60,000
ii) Bills Payable	40,000	20,000
	14,50,000	5,50,000
II Assets		
1) Non – Current Assets		
a) Fixed Assets		
i) Land & Buildings	4,00,000	2,70,000
ii) Plant & Machinery	2,00,000	1,00,000
iii) Furniture & Fixtures	50,000	20,000
b) Investment in share of S Ltd	5,00,000	
2) Current Assets		
a) Stock	1,50,000	80,000
b) Sundry Debtors	1,00,000	60,000
c) Bank Balance	50,000	20,000
	14,50,000	14,50,000

The surplus account of s Ltd had a credit balance of Rs 6000 on 1-04-2014. Prepare a consolidated Balance sheet as on 31-03-2015.

11. Explain the modes of winding of a company (CO5)

12. A company went into liquidation on 31-03-2019 the following is the balance sheet: (CO5)

Liabilities	Rs.	Assets	Rs.
<u>Paid up capital</u>		Good will	60,000
20,000 shares of Rs.10	2,00,000	Building	50,000
<u>Sundry creditors:</u>		Machinery	60,000
Preferential	25,000	Stock	55,000
Partly secured	55,000	Debtors	62,000
Unsecured	1,00,400	Cash	1,500
Bank over draft	10,000	Cash at bank	400
(unsecured)		P&L account	1,01,500
	3,90,400		3,90,400

The liquidator realized the assets as follows:

Building which was used in the first instance to pay partly secured creditors Rs.41,250.
Machinery Rs.30,000: sundry debtors Rs.35,750: stock Rs.40,000

The expenses of liquidation amounted to Rs.1,000 and the liquidators remuneration was agreed at 2% on the amount realized and 2% on amount paid to unsecured creditors.

Prepare the liquidators final statement of accounts.

AG & SG SIDDHARTHA DEGREE COLLEGE OF ARTS & SCIENCE(AUTONOMOUS),

VUYYURU – 521 165.

(MANAGED BY SIDDHARTHA ACADEMY OF GENERAL & TECHNICAL EDUCATION VIJAYAWADA)

Commerce	B.Com (Gen/Comp)	Semester-V / VI	2022-2023	CACA -501 G/C
-----------------	-------------------------	------------------------	------------------	----------------------

Advanced Corporate Accounting

Guidelines to the paper setter

	UNIT -I	UNIT -II	UNIT -III	UNIT -IV	UNIT -V
	Purchase of Business	Amalgamation of Companies	Internal Reconstruction of Companies	Accounts of Holding Companies	Liquidation
5 Marks questions	1	1	1	1	-
15 Marks questions	1(T)	1(T) +1(P)	1(P)	1(T) +1(P)	1(T) +1(P)
Weightage	20	35	20	35	30



A. G & S.G. SIDDHARTHA DEGREE COLLEGE OF ARTS & SCIENCE

Vuyyuru-521165.

NAAC recredited at 'A' level
Autonomous -ISO 9001 – 2015 Certified

TITLE OF THE PAPER: **SOFTWARE SOLUTIONS TO ACCOUNTING**
Semester: V / VI

Course Code	CSSA-502 G/C	Course Delivery Method	Class Room / Blended Mode - Both
Credits	4	CIA Marks	30
No. of Lecture Hours / Week	5	Semester End Exam Marks	70
Total Number of Lecture Hours	75	Total Marks	100
Year of Introduction:	Year of Offering: 2021 - 22	Year of Revision: ----	Percentage of Revision: 0%
CLASS:	III.B.COM., (gen/computer)		

Course Learning Outcomes

After completing the course, the student shall be able to: At the end of the course, the student will able to;

1. Understand the technical environment of accounting softwares.
2. Highlight the major accounting software in India.
3. Apply basics of accounting software into business firms for accounting transactions.
4. Understand the various versions of Tally and other softwares.
5. Integrate the concept of different Accounting softwares for accounting purpose
6. Design new approaches for use of accounting software environment.

Syllabus

SOFTWARE SOLUTIONS TO ACCOUNTING

Paper code: -CSSA-502 G/C

Unit	Learning Units	Lecture Hours
I	Computerized Accounting Microsoft Excel Spread Sheet- Functions in Excel- Preparation of Accounts, Statements and Budgets using MS Excel- Analysis and Interpretation.	15
II	Introduction to Leading Accounting Softwares– Busy - Marg – Quick Books - Zoho Books -Tally- Features and Accounting.	15
III	Tally ERP-9 - Company Creation – Tally Startup Screen- Gateway of Tally- Create a Company - Alter & Delete company- Backup and Restore- Security Features in Tally.	15
IV	Tally- Accounting Masters- Groups- Create Ledgers- Alter& Delete - Inventory Masters- Creating Stock Groups - Stock Items- Unit of Measurement- Alter & Delete.	15
V	Tally-Voucher Entry – Vouchers Types - Vouchers Entry - Alter and deleting Settings Purchase Vouchers and Sales Vouchers including Tax component –Reports Generation.	15

References

1. Nadhani, Ashok K, Tally ERP 9 Training Guide, BPB Publications
2. Tally 9 in Simple Steps, Kogent Solutions Inc., John Wiley & Sons.
3. Tally 9.0 (English Edition), (Google eBook) Computer World
4. Tally.ERP 9 Made Simple Basic Financial Accounting by BPB Publisher.
5. Tally ERP 9 For Real Time Accounting by Avichi Krishnan
6. Fundamentals of Computers, by V. Rajaraman, PHI.
7. Tally ERP 9 book advanced user, Swayam Publication (www.tallyerp9book.com)
8. *Web resources suggested by the Teacher concerned and the College Librarian including reading material*



A. G & S.G. SIDDHARTHA DEGREE COLLEGE OF ARTS & SCIENCE

Vuyyuru-521165.

NAAC reaccredited at 'A' level

Autonomous -ISO 9001 – 2015 Certified

MODAL PAPER

TITLE OF THE PAPER: SOFTWARE SOLUTIONS TO ACCOUNTING

Commerce	B.Com (Gen/Comp)	Semester-V / VI	2022-2023	CSSA-502 G/C
----------	------------------	-----------------	-----------	--------------

Max Time : 3 Hrs.

Max Marls: 70

Section -A

Answer TWO of the following

2X5=10M

1. Write about Spread Sheet(CO1)
2. Advantages of Tally (CO3)
3. Explain Delete of ledgers (CO4)
4. Voucher types (CO5)

Section -B

Answer any FOUR the following

4X15=60M

5. Name any 10 Functions in Microsoft Excel (CO1)
6. Explain Different types of Accounting Softwares (CO2)
7. Explain Features and Advantages of Gate way of Tally (CO3)
8. How to Company Creation in tally? (CO3)
9. Explain different types of Ledgers Tally (CO4)
10. Explain how to Creation Voucher? (CO5)
11. Explain Stock group creation in Tally (CO4)
12. Explain Reports of Profit and loss and Balance sheet. (CO5)

AG & SG SIDDHARTHA DEGREE COLLEGE OF ARTS & SCIENCE(AUTONOMOUS),

VUYYURU – 521 165.

(MANAGED BY SIDDHARTHA ACADEMY OF GENERAL & TECHNICAL EDUCATION VIJAYAWADA)

Commerce	B.Com (Gen/Comp)	Semester-V / VI	2022-2023	CSSA-502 G/C
-----------------	-------------------------	------------------------	------------------	---------------------

SOFTWARE SOLUTIONS TO ACCOUNTING

Guidelines to the paper setter

	UNIT -I	UNIT -II	UNIT -III	UNIT -IV	UNIT -V
	Computerized Accounting	Introduction to Leading Accounting Soft wares	Tally ERP-9 - Company Creation	Tally- Accounting Masters	Tally- Voucher Entry
5 Marks questions	1	-	1	1	1
15 Marks questions	1	1	2	2	2
Weightage	20	15	35	35	35



A. G & S.G. SIDDHARTHA DEGREE COLLEGE OF ARTS & SCIENCE

Vuyyuru-521165.
NAAC recredited at 'A' level
Autonomous -ISO 9001 – 2015 Certified

TITLE OF THE PAPER: **ADVERTISING AND MEDIA PLANNING**

Semester: V / VI

Course Code	CAMP-503 G/C	Course Delivery Method	Class Room / Blended Mode - Both
Credits	4	CIA Marks	30
No. of Lecture Hours / Week	5	Semester End Exam Marks	70
Total Number of Lecture Hours	75	Total Marks	100
Year of Introduction:	Year of Offering: 2021- 22	Year of Revision: ----	Percentage of Revision: 0%
CLASS:	III.B.COM., (gen/computer)		

Learning Outcomes:

At the successful completion of the course students are able to:

- || Understand the role of advertising in business environment
- || Understand the legal and ethical issues in advertising
- || Acquire skills in creating and developing advertisements
- || Understand up-to-date advances in the current media industry.
- || Acquire the necessary skills for planning an advertising media campaign.

Syllabus

ADVERTISING AND MEDIA PLANNING

Paper code : **CAMP-503 G/C**

Unit	Learning Units	Lecture Hours
I	Introduction, Nature and Scope Advertising- Nature and Scope- Functions - Impact on Social, Ethical and Economical Aspects - Its Significance – Advertising as a Marketing Tool and Process for Promotion of Business Development - Criticism on advertising	15
II	Strategies of Advertisements Types of Advertising Agencies and their Strategies in Creating Advertisements - Objectives - Approach - Campaigning Process - Role of Advertising Standard Council of India (ASCI) - DAGMAR approach	15
III	Process of Advertisement Creativeness and Communication of Advertising –Creative Thinking – Process – Appeals – Copy Writing - Issues in Creation of Copy Testing –Slogan Elements of Design and Principles of Design	15
IV	Media Planning Advertising Media - Role of Media - Types of Media - Print Media - Electronic Media and other Media - Advantages and Disadvantages – Media Planning - Selection of Media	15
V	Analysis of Market Media Media Strategy – Market Analysis -Media Choices - Influencing Factors - Target, Nature, Timing, Frequency, Languages and Geographical Issues - Case Studies	15

References:

1. Bhatia. K.Tej - Advertising and Marketing in Rural India - Mc Millan India
2. Ghosal Subhash - Making of Advertising - Mc Millan India
3. Jeth Waney Jaishri& Jain Shruti - Advertising Management - Oxford university Press
4. Advertising Media Planning, Seventh Edition Paperback – by Roger Baron (Author), Jack Sissors (Author)
5. Media Planning and Buying in 21st Century – Ronald DGeskey
6. Media Planning and Buying: Principles and Practice in the Indian Context – Arpita Menon
7. Publications of Indian Institute of Mass Communications
8. Advertising and Salesmanship. P. Saravanel, Margham Publications
9. Publications of ASCI
10. Web resources suggested by the Teacher concerned and the College Librarian including reading material

A.G & S.G.SIDDHARTHA DEGREE COLLEGE OF ARTS & SCIENCE

Vuyyuru-521165.

NAAC recredited at 'A' level

Autonomous -ISO 9001 – 2015 Certified

TITLE OF THE PAPER:ADVERTISING AND MEDIA PLANNING

Commerce	B.Com (Gen/Comp)	Semester-V / VI	2022-2023	CAMP-503 G/C
-----------------	-------------------------	------------------------	------------------	---------------------

Max Time: 3Hrs.

Max Marls: 70

MODAL PAPER

SECTION –A

Answer any TWO of the following

2X5=10M

1. What is advertising? (CO1)
2. DAGMAR approach (CO2)
3. Types of advertising copy (CO3)
4. Media planning (CO4)

Section –B

Answer Any FOUR of the following

4x15=60M

5. Explain the significance of advertising.(CO1)
6. What are various types of advertising agencies?(CO2)
7. Explain the role of advertising standards council of India (CO2)
8. How to decide testing of an advertising copy (CO3)
9. What is an advertising copy? Describe its elements (CO3)
10. What do you mean by print media of advertising? (CO4)
11. Explain the following concepts (CO5)
i) Target ii) Frequency iii) Timing
12. Explain media choices and its influencing factors (CO5)

AG & SG SIDDHARTHA DEGREE COLLEGE OF ARTS & SCIENCE(AUTONOMOUS),

VUYYURU – 521 165.

(MANAGED BY SIDDHARTHA ACADEMY OF GENERAL & TECHNICAL EDUCATION VIJAYAWADA)

Commerce	B.Com (Gen/Comp)	Semester-V / VI	2022-2023	CAMP-503 G/C
-----------------	-------------------------	------------------------	------------------	---------------------

ADVERTISING AND MEDIA PLANNING

Guidelines to the paper setter

	UNIT -I	UNIT -II	UNIT -III	UNIT -IV	UNIT -V
	Introduction, Nature and Scope	Strategies of Advertisements	Process of Advertisement	Media Planning	Analysis of Market Media
5 Marks questions	1	1	1	1	-
15 Marks questions	1	2	2	1	2
Weightage	20	35	35	20	30



A. G & S.G. SIDDHARTHA DEGREE COLLEGE OF ARTS & SCIENCE

Vuyyuru-521165.

NAAC reaccredited at 'A' level
Autonomous -ISO 9001 – 2015 Certified

TITLE OF THE PAPER: **SALES PROMOTION AND PRACTICE**

Semester: V / VI

Course Code	CSPP -504 G/C	Course Delivery Method	Class Room / Blended Mode - Both
Credits	4	CIA Marks	30
No. of Lecture Hours / Week	5	Semester End Exam Marks	70
Total Number of Lecture Hours	75	Total Marks	100
Year of Introduction:	Year of Offering: 2021 - 22	Year of Revision: ----	Percentage of Revision: 0%
CLASS:	III.B.COM., (gen/computer)		

Learning Outcomes:

By the end of the course students are able to:

1. Analysis of various sales promotion activities
2. Get exposed to new trends in sales Promotion
3. Understand the concepts of creativity in sales promotion
4. Enhance skills to motivate the salesperson to reach their targets
5. Develop the skills of designing of sales promotion events

Syllabus

SALES PROMOTION AND PRACTICE

Paper code: CSPP -504 G/C

Unit	Learning Units	Lecture Hours
I	Introduction to Sales Promotion: Nature and Scope of Sales Promotion- Influencing Factors - Sales Promotion and Control - Strengths and Limitations of Sales Promotion – Sales Organization - Setting-up of Sales Organization - Types of Sales Organization.	15
II	Sales Promotion and Product Life Cycle: Types of Sales Promotion - Consumer Oriented - Trade Oriented - Sales Oriented - Various Aspects -Sales Promotion methods in different Product Life Cycle – Cross Promotion - Sales Executive Functions- Theories of Personal Selling - Surrogate Selling.	15
III	Strategies and Promotion Campaign: Tools of Sales Promotion - Displays, Demonstration, Fashion Shows, Conventions - Conferences, Competitions – Steps in designing of Sales Promotion Campaign – Involvement of Salesmen and Dealers – Promotional Strategies - Ethical and Legal issues in Sales Promotion.	15
IV	Salesmanship and Sales Operations: Types of Salesman - Prospecting - Pre-approach and Approach - Selling Sequence - Sales budget, Sales territories, Sales Quota's - Point of Sale – Sales Contests - Coupons and Discounts - Free Offers - Showrooms and Exhibitions - Sales Manager Qualities and functions.	15
V	Sales force Management and Designing: Recruitment and Selection - Training - Induction - Motivation of sales personnel - Compensation and Evaluation of Sales Personnel - Designing of Events for Enhancing Sales Promotion	15

References:

1. Don.E. Schultz - Sales Promotion Essentials- Mc Graw hill India
2. S.H.H Kazmi & Satish K Batra, Advertising and Sales Promotion- Excel Books
3. Jeth Waney Jaishri& Jain Shruti - Advertising Management - Oxford university Press
4. Dr.ShailaBootwalaDr.M.D. Lawrence and Sanjay R.Mali -Advertising and Sales Promotion- NiraliPrakashan
5. Successful Sales Promotion – Pran Choudhury
6. Advertising and Sales Promotion Paperback – S. H. H. Kazmi & Satish Batra
7. Publications of ASCI
8. Kazmi & Batra, ADVERTISING & SALES PROMOTION, Excel Books, 2008
9. Web resources suggested by the Teacher concerned and the College Librarian including reading material



A. G & S.G. SIDDHARTHA DEGREE COLLEGE OF ARTS & SCIENCE

Vuyyuru-521165.

NAAC reaccrredited at 'A' level

Autonomous -ISO 9001 – 2015 Certified

TITLE OF THE PAPER: SALES PROMOTION AND PRACTICE

Commerce	B.Com (Gen/Comp)	Semester-V / VI	2022-2023	CSPP -504 G/C
----------	------------------	-----------------	-----------	---------------

MODEL PAPER

Time: 3Hrs

Max Marls: 70

Section –A

Answer any TWO of the following

2X5=10M

1. What are the factors influencing sales promotion? (CO1)
2. What is Product life cycle? (CO2)
3. What are the various tools of sales promotion? (CO3)
4. Write briefly about training induction. (CO5)

Section –B

Answer Any FOUR of the following

4X15=60M

5. Discuss the Nature and scope of sales promotion (CO1)
6. Explain various types of sales organization (CO1)
7. Describe the types of sales promotion (CO2)
8. Explain the theories of personal selling (CO2)
9. Explain various promotional strategies (CO3)
10. What are the functions and qualities of sales manager? (CO4)
11. Discuss the various types of salesmen (CO4)
12. Explain the process of recruitment and selection of sales personnel (CO5)

AG & SG SIDDHARTHA DEGREE COLLEGE OF ARTS & SCIENCE(AUTONOMOUS),

VUYYURU – 521 165.

(MANAGED BY SIDDHARTHA ACADEMY OF GENERAL & TECHNICAL EDUCATION VIJAYAWADA)

Commerce	B.Com (Gen/Comp)	Semester-V / VI	2022-2023	CSPP -504 G/C
-----------------	-------------------------	------------------------	------------------	----------------------

SALES PROMOTION AND PRACTICE

Guidelines to the paper setter

	UNIT -I	UNIT -II	UNIT -III	UNIT -IV	UNIT -V
	Introduction to Sales Promotion	Sales Promotion and Product Life Cycle	Strategies and Promotion Campaign	Salesmanship and Sales Operations	Sales force Management and Designing
5 Marks questions	1	1	1	-	1
15 Marks questions	2	2	1	2	1
Weightage	35	35	20	30	20



A. G & S.G. SIDDHARTHA DEGREE COLLEGE OF ARTS & SCIENCE

Vuyyuru-521165.

NAAC reaccredited at 'A' level

Autonomous -ISO 9001 – 2015 Certified

TITLE OF THE PAPER: **DIGITAL MARKETING**

Semester: V / VI

Course Code	CDM -505 G	Course Delivery Method	Class Room / Blended Mode - Both
Credits	4	CIA Marks	30
No. of Lecture Hours / Week	5	Semester End Exam Marks	70
Total Number of Lecture Hours	75	Total Marks	100
Year of Introduction:	Year of Offering: 2021 - 22	Year of Revision: ----	Percentage of Revision: 0%
CLASS:	III.B.COM., (gen)		

Learning Outcomes

Upon successful completion of the course students will be able to;

1. Analyze online Micro and Macro Environment
2. Design and create website
3. Discuss search engine marketing
4. Create blogs, videos, and share

Syllabus

DIGITAL MARKETING

Paper code : CDM -505 G

Unit	Learning Units	Lecture Hours
I	Introduction Digital marketing: Meaning – importance – traditional online marketing vs digital marketing – online market place analysis Micro Environment – Online Macro Environment - trends in digital marketing – competitive analysis.	15
II	Web site planning and creation Web Site: meaning – objectives – components of website - website creation – incorporation of design and– adding content, installing and activating plugins.	15
III	Search Engine Optimization (SEO) SEO: Meaning – History and growth of SEO –Importance of Search Engine - On page Optimization – off page optimization – Role of Search Engine Operation- google Ad words – Search Engine Marketing: Campaign Creation – Ad Creation, Approval and Extensions.	15
IV	Social Media Marketing: Meaning of social media and Social Media Marketing – social Management tools-strategy and planning – social media network – Social Networking – video creation and sharing – use of different social media platforms - Content creation - Blogging – Guest Blogging.	15
V	Email marketing: Meaning – Evolution of email – importance of email marketing – Development and Advancements in e mail marketing - email marketing platforms – creating and Tracking emailers–create forms – create opt-in lists – mapping industry trends and eliminating spam messages.	15

References

1. Digital Marketing for Dummies by Ryan Deiss & Russ Henneberry, publisher John Wiley first edition 2020.
2. **Youility** by Jay Baer, Published by Gilda Media LLC Portfolio 2013,
3. **Epic Content Marketing** by Joe Pulizzi, McGraw-Hill Education, 2013.
4. New Rules of Marketing and PR by David Meerman Scott. Wiley, 2017
5. **Social Media Marketing All-in-one Dummies** by Jan Zimmerman, Deborah Ng, John Wiley & Sons.
6. Digital Marketing 2020 by Danny Star, Independently Published, 2019
7. *Web sources suggested by the concerned teacher and college librarian including reading material.*



A. G & S.G. SIDDHARTHA DEGREE COLLEGE OF ARTS & SCIENCE

Vuyyuru-521165.

NAAC reaccruited at 'A' level

Autonomous -ISO 9001 – 2015 Certified

TITLE OF THE PAPER: DIGITAL MARKETING

Commerce	B.Com (Gen)	Semester-V / VI	2022-2023	CDM -505 G
----------	-------------	-----------------	-----------	------------

M
MODEL PAPER

Time: 3Hrs

Max Marls: 70M

Section –A

Answer any TWO of the following

2X5=10M

1. What is Digital Marketing? (CO1))
2. . Explain Website planning. (CO2)
3. Describe the importance Search Engine (CO3)
- 4.What is social media marketing (CO4)

Section –B

Answer Any FOUR of the following

4X15=60M

5. Define marketing. Explain the differences between traditional marketing VS digital marketing (CO1)
6. Explain trends in digital marketing. (CO1)
- 7.What are the components of website? (CO2)
8. Explain the History and Growth of SEO. (CO3)
9. Describe about the search engine marketing. (CO3)
10. What are the goals of social media marketing (CO4)
11. Explain the importance of Email marketing (CO5)
12. Write about mapping industry trends and eliminating spam messages? (CO5)

AG & SG SIDDHARTHA DEGREE COLLEGE OF ARTS & SCIENCE(AUTONOMOUS),

VUYYURU – 521 165.

(MANAGED BY SIDDHARTHA ACADEMY OF GENERAL & TECHNICAL EDUCATION VIJAYAWADA)

Commerce	B.Com (Gen)	Semester-V / VI	2022-2023	CDM -505 G
-----------------	--------------------	------------------------	------------------	-------------------

DIGITAL MARKETING

Guidelines to the paper setter

	UNIT -I	UNIT -II	UNIT -III	UNIT -IV	UNIT -V
	Introduction	Web site planning and creation	Search Engine Optimization (SEO)	Social Media Marketing	Email marketing
5 Marks questions	1	1	1	1	-
15 Marks questions	2	1	2	1	2
Weightage	35	20	35	20	30



**A. G & S.G. SIDDHARTHA DEGREE COLLEGE
OF ARTS & SCIENCE**

Vuyyuru-521165.

NAAC re accredited at 'A' level

Autonomous -ISO 9001 – 2015 Certified

TITLE OF THE PAPER: Service Marketing

Semester: V / VI

Course Code	CSM -506 G	Course Delivery Method	Class Room / Blended Mode - Both
Credits	4	CIA Marks	30
No. of Lecture Hours / Week	5	Semester End Exam Marks	70
Total Number of Lecture Hours	75	Total Marks	100
Year of Introduction:	Year of Offering: 2021- 22	Year of Revision: ----	Percentage of Revision: 0%
CLASS:	III.B.COM., (gen)		

Learning Out comes

Upon successful completion of the course the student will be able to;

1. Discuss the reasons for growth of service sector.
2. Examine the marketing strategies of Banking Services, insurance and education services.
3. Review conflict handling and customer Responses in services marketing
4. Describe segmentation strategies in service marketing.
5. Suggest measures to improve services quality and their service delivery.

Syllabus

Service Marketing

Paper code:CSM -506 G

Unit	Learning Units	Lecture Hours
I	Introduction: Nature and Scope of services Introduction: Nature and Scope of services characteristics of services, classification of services – need for service marketing - reasons for the growth of services sector, Overview of marketing Different Service Sectors -Marketing of Banking Services -Marketing in Insurance Sector - Marketing of Education Services.	15
II	Consumer Behavior in Services Marketing Customer Expectations on Services- Factors influencing customer expectation of services. - Service Costs experienced by Consumer, the Role of customer in Service Delivery, Conflict Handling in Services, Customer Responses in Services, Concept of Customer Delight	15
III	Customer Relationship marketing and Services Market Segmentation. Customer Relationship marketing: Meaning -Importance of customer & customer's role in service delivery, Benefits of customer relationship, retention strategies. Services Market Segmentation: - Market segmentation -Basis & Need for segmentation of services, bases of segmentation services, segmentation strategies in service marketing.	15
IV	Customer Defined Service Standards. Customer Defined Service Standards - Hard and Soft, Concept of Service Leadership and Service Vision -Meeting Customer Defined Service Standards - Service Flexibility Versus Standards - Strategies to Match Capacity and Demand - managing Demand and Supply of Service –applications of Waiting Line and Queuing Theories to Understand Pattern Demand.	15
V	Service Development and Quality Improvement. Service Development – need, importance and Types of New Services - stages in development of new services, service Quality Dimensions - Service Quality Measurement and Service Mapping, Improving Service Quality and Service Delivery, Service Failure and Recovery.	15

References

1. John E.G. Bateson, K.Douglas Hoffman: Services Marketing, Cengage Learning, 4e, 2015 publication
2. Vinnie Jauhari, Kirti Dutta: Services Marketing: Operations and Management, Oxford University Press, 2014.
3. Valarie A. Zeithaml and Mary Jo-Bitner: Services Marketing – Integrating Customer Focus Across The Firm, Tata McGraw Hill Publishing Company Ltd., 6e, 2013.
4. Nimit Chowdhary, Monika Chowdhary, Textbook of Marketing Of Services: The Indian Experience, Macmillan, 2013.
5. K. Rama Mohana Rao, Services Marketing, Pearson, 2e, 2011.
6. Dr. K. Karunakaran, Service Marketing (Text and Cases in Indian Context), Himalaya Publications.
7. *Web sources suggested by the concerned teacher and college librarian including reading material.*



A. G & S.G. SIDDHARTHA DEGREE COLLEGE OF ARTS & SCIENCE

Vuyyuru-521165.

NAAC reaccruited at 'A' level

Autonomous -ISO 9001 – 2015 Certified

TITLE OF THE PAPER: **Service Marketing**

Commerce	B.Com (Gen)	Semester-V / VI	2022-2023	CSM -506 G
----------	-------------	-----------------	-----------	-------------------

M
MODEL PAPER

Time: 3Hrs

Max Marls: 70

Section –A

Answer any TWO of the following

2X5=10M

- 1.Explain the Scope of Services (CO1)
2. Explain the Concept of customer delight (CO2)
3. Why customer relationship is important? (CO3)
4. Explain the demand and supply of services (CO4)

Section –B

Answer Any FOUR of the following

4X15=60M

5. Define Services Marketing. Explain the classification of services. (CO1)
6. What is services marketing? Discuss different service sectors. (CO1)
7. what are the factors that influence customer expectation of services? (CO2)
8. Define market segmentation. Discuss need and basis for segmentation services. (CO3)
9. What are the various types of customer retention strategies (CO3)
10. describe customer defined service standards . (CO4)
11. What are the various stages to develop a new services(CO5)
12. Discuss the service quality dimensions (CO5)

Commerce	B.Com (Gen)	Semester-V / VI	2022-2023	CSM -506 G
----------	-------------	-----------------	-----------	------------

Service Marketing

Guidelines to the paper setter

	UNIT -I	UNIT -II	UNIT -III	UNIT -IV	UNIT -V
	Introduction: Nature and Scope of services	Consumer Behavior in Services Marketing	Customer Relationship marketing and Services Market Segmentation	Customer Defined Service Standards.	Service Development and Quality Improvement.
5 Marks questions	1	1	1	1	-
15 Marks questions	2	1	2	1	2
Weightage	35	20	35	20	30

V/VI SEMESTERS INTERNSHIP

THE - END

**A.G& S.G.SIDDHARTHA DEGREE COLLEGE OF ARTS &
SCIENCE**

VUYYURU-521165, KRISHNA Dt., A.P.(Autonomous)

Accredited by NAAC with "A" Grade

2022-2023



DEPARTMENT OF COMPUTER SCIENCE

MINUTES OF BOARD OF STUDIES





ODD SEMESTER

26-10-2023

Minutes of the meeting of Board of Studies in Computer Science for Semester I, III & V of I, II & III years B.Sc. (MPCs, MCCs, MSCs), B.Com. (C.A.) and B.Com (e-Commerce) Life Skill Course and Skill Development Course of AG & SG Siddhartha Degree College of Arts & Science, Vuyyuru, held at 3.00 P.M on 26-10-2022 in the Department of Computer Science.

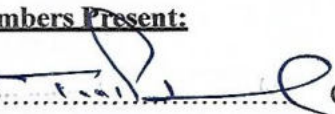
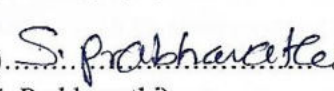
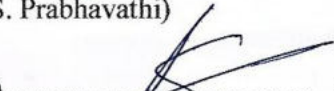
Sri T.NagaPrasadaRao ... Presiding

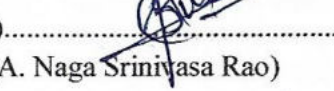
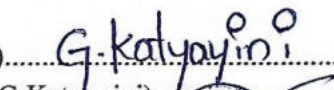
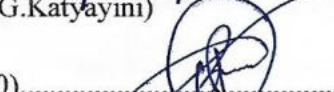
Members Present:

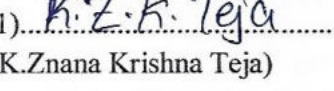
- 1)..... Chairman Head, Department of Computer Science,
(T.Naga Prasada Rao) AG&SG Siddhartha Degree College of Arts & Science.
- 2) ----- University Principal, Krishna University College of Engineering
(Dr. M. Babu Reddy) Nomine and Technology, Machilipatnam.
- 3). ----- Subject Principal, HOD of Department of Computer Science
(Dr. P. J. S Kumar) Expert A.N.R College Gudivada.
- 4) ----- Subject TPO, Department of Computer Science
(Mr. K. Sridhar) Expert PB Siddhartha College of Arts & Science, VJA
- 5) ----- Industrial .Net Developer, Maven Soft System Pvt. Ltd
(R. Sowjanya) Expert Madaapur, Hyderabad.
- 6)..... Member Lecturer in Computer Science, AG&SG Siddhartha
(S. Prabhavathi) Degree College of Arts & Science, Vuyyuru-521165
- 7)..... Member Lecturer in Computer Science, AG&SG Siddhartha
(A. Sravani) Degree College of Arts & Science, Vuyyuru-521165
- 8)..... Member Lecturer in Computer Science, AG&SG Siddhartha
(A. Naga Srinivasa Rao) Degree College of Arts & Science, Vuyyuru-521165
- 9)..... Member Lecturer in Computer Science, AG&SG Siddhartha
(G.Katyayini) Degree College of Arts & Science, Vuyyuru-521165
- 10)..... Member Lecturer in Computer Science, AG&SG Siddhartha
(O.Teja Sri) Degree College of Arts & Science, Vuyyuru-521165
- 11)..... Member Lecturer in Computer Science, AG&SG Siddhartha
(K.Znana Krishna Teja) Degree College of Arts & Science, Vuyyuru-521165
- 12)..... Member Student in M.Sc. CS, AG& SG Siddhartha
(G.Lavanya) Degree College of Arts & Science, Vuyyuru-521165
- 13)..... Member Student in B.Sc. MPCs, AG& SG Siddhartha
(G.Jahnvi) Degree College of Arts & Science, Vuyyuru-521165



Agenda for B.O.S Meeting.

1. To discuss introducing Syllabi and Model papers for Elective Skill Enhancement Courses (SEC) for B.Sc. (MPCs, MCCs) & B.Com (C.A) programmes in Fifth/Sixth Semester adopting COs in line with guidelines of OBE following Blooms Taxonomy for the students admitted in the Academic year 2020-2021 and onwards.
2. To Discuss and approve the Structure and Syllabi and model papers of B. Sc. (MPCs, MCCs, MSCs), B.Com (C.A) & B.Com(e-commerce-Computers) programme in First and Third semesters for the student admitted in the academic year 2022-23 and onwards.
3. To recommend any changes in the syllabi for I, III, V & VI Semesters of I, II, III year Degree B.Sc.(MPCs, MCCs, MSCs), B.Com.(C.A.) and B.Com(e-commerce-Computers).
4. To Introduce a Life Skill Course and Skill Development Course for all B.Sc and B.Com from the Academic Year 2022-23.
5. To recommend the teaching and evaluation methods to be followed under Autonomous status.
6. To recommend the panel of paper setters and examiners to the controller of the examinations of autonomous courses of AG & SG Siddhartha Degree College of Arts & Science College, Vuyyuru.
7. Any other matter

Resolutions.

1. It is Resolved and Recommended to adopt the same structure, syllabi & Model papers for Elective Skill Enhancement Courses (SEC) for B.Sc. (MPCs, MCCs) & B.Com (C.A) programmes with titles Big Data Analytics using R, Data science using Python in Fifth/Sixth Semester adopting COs in line with guidelines of OBE following Blooms Taxonomy for the students admitted in the Academic year 2020-2021 and onwards.
2. It is Resolved and recommend to continue the syllabi without any changes, but only changes on Model Paper i.e. for I Semester of I Year & V/VI Semester of III year B.Sc. (MPCs, MCCs, MSCs), B.Com.(CA) & B.Com(e-commerce- Computers).
3. It is Resolved and Recommend to introduce new Syllabi and Model Question paper as per new regulations in III Semester of II Year Degree B.Sc. (MPCs, MCCs) and B.Com(CA).
4. It is Resolved to implements Life Skill Course and Skill Development Course for all B.Sc and B.Com from the Academic Year 2022-23.
5. It is resolved to continue the teaching and evaluation methods to be followed under Autonomous status.
6. It is resolved to continue the panel of paper setters and examiners to the controller of the examinations of autonomous courses of AG & SG Siddhartha Degree College of Arts & Science College, Vuyyuru.
7. Any other matter

Teaching methods:

Besides the conventional methods of teaching, we use modern technology i.e. Using of LMS and LCD projector to display on power board etc..for better understanding of concepts.

Evaluation of a student is done by the following procedure:

There are two components in the Valuation and Assessment of a student – Internal Assessment (IA) Semester Examinations (SE). **For the Batch of Students Admitted from 2022-23.**

Internal Assessment (IA)

- The maximum mark for IA is 30 and SE is 70 for theory; and for practical marks for IA 10 and 40 Marks for External Exam.
- Each IA written examination is of 1 hour 30 minutes duration for 20 marks. The tests will be conducted centrally. The average of two such IA is calculated for 20 marks.
- Attendance will be for 5 Marks. The other innovative component is for 5 marks, conducted during the class hours by the staff member/ in charge of the subject, in the form of assignments/ quiz/ seminars /PPT/Online- assignments/Open Book/Viva Voce/ Group work/ Mini Project/ Exhibition, etc. The topic and time for submission/ presentation will be announced by the staff member/ in charge of the subject in advance. Each student should explain and defend his/her presentation.
- The semester examination will be of 3 hours with maximum 70 marks.

Internal Assessment (IA) For the Batch of Students Admitted from 2021-22.

- The maximum mark for IA is 25 and SE is 75 for theory; and for practical marks for IA 10 and 40 Marks for External Exam.
- Each IA written examination is of 1 hour duration for 15 marks. The tests will be conducted centrally. The average of two such IA is calculated for 15 marks.

- Other Innovative Components will be for 5 Marks. The innovative component is for 5 marks, conducted during the class hours by the staff member/ in charge of the subject, in the form of assignments/ quiz/ seminars /PPT/Online- assignments/Open Book/Viva Voce/ Group work/ Mini Project/ Exhibition, etc. The topic and time for submission/ presentation will be announced by the staff member/ in charge of the subject in advance. Each student should explain and defend his/her presentation.
- The semester examination will be of 3 hours with maximum 75 marks.

Internal Assessment (IA) For the Batch of Students Admitted from 2020-21.

- The maximum mark for IA is 30 and SE is 70 for theory; and for practical marks for IA 10 and 40 Marks for External Exam.
- Each IA written examination is of 1 hour 30 minutes duration for 20 marks. The tests will be conducted centrally. The average of two such IA is calculated for 20 marks.
- Attendance will be for 5 Marks. The other innovative component is for 5 marks, conducted during the class hours by the staff member/ in charge of the subject, in the form of assignments/ quiz/ seminars /PPT/Online- assignments/Open Book/Viva Voce/ Group work/ Mini Project/ Exhibition, etc. The topic and time for submission/ presentation will be announced by the staff member/ in charge of the subject in advance. Each student should explain and defend his/her presentation.
- The semester examination will be of 3 hours with maximum 70 marks.

Semester Examinations (SE)

- A student should register himself/herself to appear for the Semester Examinations by payment of the prescribed fee.
- The Semester Examinations will be in the form of a comprehensive examination covering the entire syllabus in each subject. It will be of 3 hours duration & Foundation course 2 hours irrespective of the number of credits allotted to it.
- If a candidate fails to obtain pass marks even after the due to less mark in the IA examination, the marks of the next examination will be converted to be out of 100.
- Even though the candidate is absent for two IA exams/obtain zero marks the external marks are considered (if he/she gets 40/100) and the result shall be declared as 'PASS'.
- The maximum marks for each Paper shall be 100.

Question paper guide lines for Practical Examinations at the end of Semesters I, III & V Two Practical Programs to be conducted out of 15 programs at the end of Semester I, III & V Practical Examination time 3Hrs and Maximum Marks 50 Scheme of valuation Semesters – I, III & V B.Sc.& B.Com.(C.A), B.Com.(e-commerce-Computers).

Computer Science Practical's - External (Time: 3 hrs.) Total Marks: 40M

1. Programs writing (2):20 marks,
2. Viva voice : 5 marks
3. Execution &Result : 15 marks

Total Marks	:				-----
					40

Computer Science Practical's- Internal

Total Marks: 10 M

1. Record : 10 marks

6.) Discussed and recommended for organizing Seminars, Guest lectures, Work-shops to upgrade the knowledge of students, for the approval of the Academic Council.

7) Discussed and empowered the HOD to suggest the panel of the paper setters and examiners to the controller of the examinations.

8). We implemented online certificate courses & Internships such as NPTL, APSSDC - PYTHON, R-Programming, Amazon Web services and JAVA----- etc. To fill the curriculum gaps from II year Degree on words

9). Suggestions



Chairman

Appendix-I

**LIST OF THE COURSES REVISED/ INTRODUCED IN V/VI SEMESTERS
(2022 – 2023) BSC(MPCS,MCCS), I,III SEMESTERS OF B.Sc (MPCs,MCCs,MSCs)**

SEM NO	Course Code	Course No.	Title of Course	Hrs. / Week		Credits		Marks			
				Th.	Lab	Th.	Lab	Int. Max. Marks	SEE	Total Marks	
V/VI	SECCSCT01	6A	Web Interface Designing Technologies	3		3		30	70	100	
	SECCSCP01		Web Interface Designing Technologies Lab		3		2	10	40	50	
	SECCSCT02	7A	Web Applications Development using PHP& MYSQL	3		3		30	70	100	
	SECCSCP02		Web Applications Development using PHP& MYSQL Lab		3		2	10	40	50	
OR											
V/VI	SECCSCT03	6B	Internet of Things	3		3		30	70	100	
	SECCSCP03		Internet of Things Lab		3		2	10	40	50	
	SECCSCT04	7B	Application Development using Python	3		3		30	70	100	
	SECCSCP04		Application Development using Python Lab		3		2	10	40	50	
	OR										
	SECCSCT05	6C	Data science	3		3		30	70	100	
	SECCSCP05		Data science Lab		3		2	10	40	50	
	SECCSCT06	7C	Python for Data Science	3		3		30	70	100	
SECCSCP06	Python for Data Science Lab			3		2	10	40	50		
III	CSCT37	3A	Data Base Management System	3		3		25	75	100	
III	CSCP37	3A	Data Base Management System Lab		2		1	10	40	50	
I	CSCT11B	IA	Problem solving in C	3		3		30	70	100	
I	CSCP11B	IA	Problem solving in C Lab		2		1	10	40	50	

Appendix-II

**LIST OF THE COURSES REVISED/ INTRODUCED IN V/VI SEMESTERS
(2022 – 2023) B.COM (C.A) I,III SEMESTERS OF B.Com(C.A)&
B.Com(e-commerce-Computers)**

SEM NO	Course Code	Course No.	Title of Course	Hrs. / Week		Credits		Marks			
				Th.	Lab	Th.	Lab	Int. Max. Marks	SEE	Total Marks	
V/VI	SECCAT01	6A	Big data Analytics using R	3		3		30	70	100	
	SECCAP01		Big data Analytics using R Lab		3		2	10	40	50	
	SECCAT07	7A	Data Science using Python	3		3		30	70	100	
	SECCAP07		Data Science using Python Lab		3		2	10	40	50	
	OR										
	SECCAT03	6B	Mobile application development	3		3		30	70	100	
	SECCAP03		Mobile application development Lab		3		2	10	40	50	
	SECCAT04	7B	Cyber Security and Malware Analysis	3		3		30	70	100	
	SECCAP04		Cyber Security and Malware Analysis Lab		3		2	10	40	50	
	OR										
	SECCAT05	6C	E Commerce Application Development	3		3		30	70	100	
	SECCAP05		E Commerce Application Development Lab		3		2	10	40	50	
SECCAT06	7C	Real time governance system (RTGS)	3		3		30	70	100		
SECCAP06		Real time governance system (RTGS) Lab		3		2	10	40	50		
OR											
V/VI	SECCAT07	6D	Multimedia Tools and Applications	3		3		30	70	100	
	SECCAP07		Multimedia Tools and Applications Lab		3		2	10	40	50	
	SECCAT08	7D	Digital Imaging	3		3		30	70	100	

	SECCAP08		Digital Imaging Lab		3		2	10	40	50
III	CABT31A	3A	Programming with C & C++	3		3		25	75	100
III	CABP31A	3A	Programming with C & C++ Lab		2		1	10	40	50
III	CSCT11B	3B	Problem Solving in 'C'	3		3		25	75	100
III	CSCP11B	3B	Problem Solving in 'C' LAB		2		1	10	40	50
I	CSBT11A	IA	Information Technology	5		4		30	70	100
I	CABT22A	IB	Computer Applications	3		3		30	70	100
I	CABP22A	IB	Computer Applications		2		1	10	40	50

Note-1: For Semester–V, for the domain subject Computer Science any one of the three pairs of SECs shall be chosen as courses 16,17,18,19,20 and 21, i.e., 16A & 17A or 16B & 17B or 16C & 17C and so on. The pair shall not be broken (ABCD allotment is random, not on any priority basis).

Note-2: One of the main objectives of Skill Enhancement Courses (SEC) is to inculcate field related skills of the domain subject in students. The syllabus of SEC will be partially skill oriented. Hence, teachers shall also impart practical training to students on the skills embedded in syllabus citing related real field situations.

A.G & S.G.SIDDHARTHA DEGREE COLLEGE OF ARTS & SCIENCE

Vuyyuru-521165.NAAC reaccrredited at 'A' level

Autonomous -ISO 9001 – 2015 Certified

Title of the Paper: WEB INTERFACE DESIGNING TECHNOLOGIES

Semester: V/VI

Course Code	SECCSCT01	Course Delivery Method	Class Room / Blended Mode - Both
Credits	3	CIA Marks	30
No. of Lecture Hours / Week	3	Semester End Exam Marks	70
Total Number of Lecture Hours	60	Total Marks	100
Year of Introduction :2022-23	Year of Offering: 2022 -23	Year of Revision: ----	Percentage of Revision: 0%

Course Objective: To create web elements like buttons, banners & Bars and of course complete UI designs. Forms and validations for your website. Setting up page layout, color schemes, contract, and typography in the designs. Writing valid and concise code for web pages.

Course Outcomes: Students at the successful completion of the course will be able to:

CO ₁	Understand web application and static web page using Html. (PO5)
CO ₂	Gain knowledge about various designing of style sheets. (PO5)
CO ₃	Demonstrate skills regarding creation of an interface to dynamic website.(PO7)
CO ₄	Gain knowledge about various advantages of XML and validating schema(PO5)
CO ₅	Learn how to install word press and gain the knowledge of installing various plugins to use in their websites. (PO5,PO7)

Syllabus

Course Details

Unit	Learning Units	Lecture Hours
I	<p>Web Designing, HTML Web Designing: Introduction To Web Designing, Difference Between Web Applications And Desktop Applications. HTML: Introduction To HTML, Introduction To HTML, Headings, Paragraphs Styles & Colors, HTML Formatting, Quotations, Comments, Hyperlinks, Lists, Using colors and images, Tables, Multimedia Objects - Video, Audio, Plugins, You Tube, Frames, Forms</p>	12
II	<p>CSS, HTML API'S CSS: Introduction, Using Styles, Simple Examples, Defining Your Own Styles, Properties and Values in Styles, Style Sheets, Formatting blocks of information, Layers, CSS Combinators, Pseudo Class, Pseudo Elements, Opacity, ToolTips, Image Gallery, CSS Forms, CSS Counters, CSS Responsive. HTML API'S: Geolocation, Drag/drop, local storage, HTML SSE</p>	12
III	<p>Client side Validation: Introduction to JavaScript: What Is DHTML?, JavaScript Basics, Variables, String Manipulations, Mathematical Functions, Statements, Operators, Arrays, Functions. Objects in JavaScript – Data and Objects In JavaScript, Regular Expressions, Exception Handling. DHTML with JavaScript :Data Validation, Opening a New Window, Messages and Confirmations, The Status Bar, Different Frames, Rollover Buttons, Moving Images</p>	14
IV	<p>XML: Introduction to xml, How to write a xml document, Elements and attributes, Comments in xml, Namespace in xml, Xml css, Advantages of xml, Uses of xml, xml schema, data types, simple types, complex types , Validating DTD, XSD.</p>	12
V	<p>Word press Introduction to word press, servers like wamp, bitnami e.tc, installing and configuring word press, understanding admin panel, working with posts and pages, using editor, text formatting with shortcuts, working with media-Adding, editing, deleting media elements, working with widgets, menus.</p>	10

Text Book/ references / e-books/websites

1. Chris Bates, Web Programming Building Internet Applications, Second Edition, Wiley
2. Web technologies by A.A.Puntambekar
3. Web Technologies by N.P.Gopalan, Eastern Economy Edition, 2nd edition
4. Paul S.Wang Sanda S. Katila, an Introduction to Web Design plus Programming, Thomson
5. Head First HTML and CSS, Elisabeth Robson, Eric Freeman, O'Reilly Media Inc.
6. An Introduction to HTML and JavaScript: for Scientists and Engineers, David R. Brooks.
7. Schaum's Easy Outline HTML, David Mercer, McGraw Hill Professional.
8. Word press for Beginners, Dr. Andy Williams.
9. Professional word press, Brad Williams, David damstra, Hanstern.
10. Web resources:
 - a. <http://www.codecademy.com/tracks/web>
 - b. <http://www.w3schools.com>
 - c. <https://www.w3schools.in/wordpress-tutorial/> d. <http://www.homeandlearn.co.uk>

AG & SG SIDDHARTHA COLLEGE OF ARTS AND SCIENCES - VUYYURU.

An Autonomous college within the jurisdiction of Krishna University A.P, India.

(With Effect from Academic Year 2022-23)

COMPUTER SCIENCE	SECCSCT01	2022-23	B.SC(MPCS,MCCS)
-------------------------	------------------	----------------	------------------------

SEMESTER – V/VI

PAPER – VI

Max. Marks 70

Model Paper: WEB INTERFACE DESIGNING TECHNOLOGIES

NO of Hours: 3

No Of Credits: 3

Pass Marks 28

SECTION – A

Short Answer Questions

Answer any Four questions. (At least 1 question should be given from each Unit)

(4x5=20Marks)

- 1.What is HTML? Explain features and structure of HTML program with example(CO1,L1)
2. What is layer? How are they described with HTML code?(CO1,L1)
- 3.Explain hyperlinks in HTML.(CO2,L5)
- 4.What is java script? Explain the features ,advantages and disadvantages of java script(CO3,L1)
5. What are the elements and attributes used in XML(CO4,L1)
6. Explain text formatting in word Press.(CO5,L5)

SECTION-B

Answer all questions.

(5 x 10 = 50 Marks)

9(a) What is list? Explain various types of lists in HTML.(CO1,L1)

OR

9(b) Explain Frames and forms in HTML(CO1,L2)

10(a) Define CSS, Explain various styles sheets in HTML(CO2,L1)

OR

10(b). Explain HTML APIs.(CO1,L2)

11(a).What is DHTML? Explain about various string and mathematical functions(CO3,L2)

OR

11(b) Explain Exception handling and rollover buttons in java script(CO3,L2)

12(a).What are the advantages of using XML and CSS? How to validate XML schema.(CO4,L1)

OR

12(b) Explain about DTD in XML(CO4,L2)

13(a) What is admin panel, what are the steps involved in working with post and pages (CO5,L1)

OR

13(b) Explain how we can add, edit and deleting media elements in word press(CO5,L2)

AG & SG SIDDHARTHA COLLEGE OF ARTS AND SCIENCES - VUYYURU.

An Autonomous college within the jurisdiction of Krishna University A.P, India.

(With Effect from Academic Year 2022-23)

COMPUTER SCIENCE	SECCSCT01	2022-23	B.SC(MPCS,MCCS)
------------------	-----------	---------	-----------------

SEMESTER – V/VI

PAPER – VI

Max. Marks 50

Lab List: **WEB INTERFACE DESIGNING TECHNOLOGIES LAB**

No. of Hours per week: 3

External: 40

Internal: 10

Credits: 2

I. Course Outcomes: Students at the successful completion of the course will be able to:

CO1: Create a basic website with the help of HTML and CSS.(PO5)

CO2: Acquire the skill of installing word press and various plugins of Word press.(PO5)

CO3: Create a static website with the help of Word press..(PO5,PO7)

CO4: Create an interface for a dynamic website.(PO5,PO7)

CO5: Apply various themes for their websites using Word press.(PO7)

II. Practical (Laboratory) Syllabus: (30 periods)

HTML and CSS:

1. Create an HTML document with the following formatting options:

(a) Bold, (b) Italics, (c) Underline, (d) Headings (Using H1 to H6 heading styles), (e) Font (Type, Size and Color), (f) Background (Colored background/Image in background), (g) Paragraph, (h) Line Break, (i) Horizontal Rule, (j) Pre tag

2. Create an HTML document which consists of:

(a) Ordered List (b) Unordered List (c) Nested List (d) Image

3. Create a form using HTML which has the following types of controls:

(a) Text Box (b) Option/radio buttons (c) Check boxes (d) Reset and Submit buttons

4. Embed a calendar object in your web page.

5. Create an applet that accepts two numbers and perform all the arithmetic operations on them.

6. Create nested table to store your curriculum with image.

7. Create a form that accepts the information from the subscriber of a mailing system.

8. Create a help file as follows:

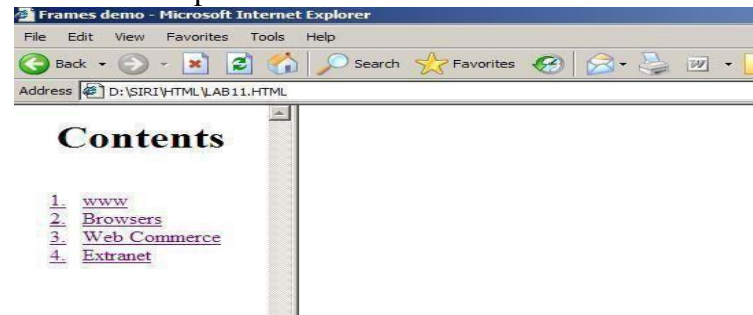

9. Write a html program including style sheets.

10. Write a html program to layers of information in web page.

11. Develop a Java script to determine whether the given number is a “PERFECT NUMBER “or not.

12. Develop a Java script to generate “ARMSTRONG NUMBERS” between the ranges 1 to 100.

13. Write a java script that reads an integer and displays whether it is a prime number or not.

14. Write a java script which accepts the text in lower case and displays the text in upper case

15. Write a java script program for user name and password validation using on click event.

Word press:

16. Installation and configuration of word press.
17. Create five pages on COVID – 19 and link them to the home page.
18. Add an external video link with size 640 X 360.
19. Create a user and assign a role to him.
20. Create a login page to word press using custom links

III. Lab References:

1. Web technologies by A.A.Puntambekar
2. Web Technologies by N.P.Gopalan, Eastern Economy Edition, 2nd edition
3. Word press for Beginners, Dr. Andy Williams.
4. Professional word press, Brad Williams, David damstra, Hanstern.

Reference Materials on the Web/web-links:

1. https://onlinecourses.nptel.ac.in/noc17_cs22/course
2. <http://www.codecademy.com/tracks/web>
3. <http://www.w3schools.com>
4. <https://www.w3schools.in/wordpress-tutorial/>

A.G & S.G.SIDDHARTHA DEGREE COLLEGE OF ARTS & SCIENCE

Vuyyuru-521165.NAAC reaccredited at 'A' level

Autonomous -ISO 9001 – 2015 Certified

Title of the Paper: WEB APPLICATIONS DEVELOPMENT USING PHP AND MYSQL

Semester: V/VI

Course Code	SECCSCT02	Course Delivery Method	Class Room / Blended Mode - Both
Credits	3	CIA Marks	30
No. of Lecture Hours / Week	3	Semester End Exam Marks	70
Total Number of Lecture Hours	60	Total Marks	100
Year of Introduction :2015-16	Year of Offering: 2022 -23	Year of Revision: ----	Percentage of Revision: 30%

Course Objective: Upon successful completion of the course, participants should be able to: **List the major elements of the PHP & MySQL work and explain why PHP is good for web development.**

Learn how to take a static website and turn it into a dynamic website run from a database using PHP and MySQL.

Course Outcomes: Students at the successful completion of the course will be able to:

CO ₁	Learn basic structure and key concepts in PHP, Control statements and functions concept and related programs (PO5)
CO ₂	Know What is an Array concept related programs, What is an Object, various objects, Formatting strings, Date and time and related programs (PO5)
CO ₃	Learn importance of Forms, Combining HTML with PHP code. Importance of Cookies and Sessions related programs of forms cookies and sessions. (PO5)
CO ₄	Know importance of File concept in PHP how to Create, Open, Read and write data in file related programs, Knowing about Image creation, drawing, and modification image (PO7)
CO ₅	Know about Database concept of MySQL, Connection, Creation of Database, Table adding Record into it related programs (PO7)

PHP Syllabus

Course Details

Unit	Learning Units	Lecture Hours
I	The Building blocks of PHP : Variables, Data Types, Operators and Expressions, Constants. Flow Control Functions in PHP: Switching Flow, Loops, Code Blocks and Browser Output. Working with Functions: What is function? ,Calling functions, Functions, Returning the values from User-Defined Functions, Variable Scope.	12
II	Working with Arrays: What are Arrays?, Creating Arrays, Working with Objects Creating Objects, Object Inheritance, Working with Strings, Dates and Time- Formatting strings with PHP, Investigating Strings with PHP, Manipulating Strings with PHP, Using Date and Time Functions in PHP.	12
III	Working with Forms- Creating Forms, Accessing Form Input with User defined Arrays, Combining HTML and PHP code on a single Page, Working with Cookies and User Sessions- Introducing Cookies, Setting a Cookie with PHP, Session Function Overview, Starting a Session, Working with session variables	14
IV	Working with Files and Directories: Creating and Deleting Files, Opening a File for Writing, Reading or Appending, Reading from File, Writing or Appending to a File. Working with Images -Understanding the Image-Creation Process, Drawing a New Image ,Modifying Existing Images ,Image Creation from User Input.	12
V	Interacting with MySQL using PHP -MySQL versus MySQLi Functions, Connecting to MySQL with PHP ,Working with MySQL Data, Creating an Online Address Book -Planning and Creating Database Tables, Creating Menu, Creating Record, Addition Mechanism, Viewing Records, Creating the Record Deletion Mechanism, Adding Sub-entities to a Record.	10

Textbooks and References

1. JulieC.Meloni, SAMS Teach yourself PHP MySQL and Apache, Pearson education
2. Steven Holzner, PHP: The Complete Reference, McGraw-Hill
3. RobinNixon, LearningPHP,MySQL,JavaScript,CSS&HTML5,ThirdEditionO'reilly,2014
4. XueBaiMichaelEkedahl, The web warrior guide to Web Programming, Thomson (2006).
5. Web resources:
 - e. <http://www.codecademy.com/tracks/php>
 - f. <http://www.w3schools.com/PHP>
 - g. <http://www.tutorialpoint.com>

AG & SG SIDDHARTHA COLLEGE OF ARTS AND SCIENCES - VUYYURU.
An Autonomous college within the jurisdiction of Krishna University A.P, India.
(With Effect from Academic Year 2015-16)

COMPUTER SCIENCE	SECCSCT02	2022-23	B.SC(MPCS,MCCS)
SEMESTER – V/VI	PAPER – VII	Max. Marks 70	

Model Paper: Web Applications Development using PHP & MYSQL

NO of Hours: 3

No Of Credits: 3

Pass Marks 28

SECTION – A

Short Answer Questions

(4 x 5=20 Marks)

Answer any Four questions. (At least 1 question should be given from each Unit)

- 1) Define Structure of PHP.(CO1,L1)
- 2) Differentiate Conditional statement and Looping statement with syntax.(CO1,L4)
- 3) Define Array concept explain about it.(CO2,L1)
- 4) Explain about Cookies concept.(CO3,L2)
- 5) Explain about Image creation.(CO4,L2)
- 6) Write short note on Mysqli.(CO5,L1)

SECTION B

(5 x 10=50 Marks)

Answer all questions. (Two questions should be given from each unit with internal choice)

9(a) Explain about Control Statements.(CO1,L2)

OR

9(b) Discuss about Function define, Call and return value with example.(CO1,L6)

10(a) List various types of Formatting strings explain them.(CO2,L2)

OR

10(b) Define Array function with example.(CO2,L1)

11(a) Write names of Form objects explain them with example.(CO3,L2)

OR

11(b) Compare and Contrast Session and Cookies.(CO3,L4)

12(a) Explain File concept about file creation, Open file, Write file and Delete file with example(CO4,L2)

OR

12(b) Construct steps for Interfacing complete image concept explain them with one example.(CO4,L3)

13(a) Discuss about DDL commands and DML commands in Mysqli with syntaxes (CO5,L6)

OR

13(b) Write code to Create table of Employee by adding any four columns with example.(CO5,L6)

AG & SG SIDDHARTHA COLLEGE OF ARTS AND SCIENCES - VUYYURU.

An Autonomous college within the jurisdiction of Krishna University A.P, India.

(With Effect from Academic Year 2015-16)

COMPUTER SCIENCE	SECCSCT02	2022-23	B.SC(MPCS,MCCS)
-------------------------	------------------	----------------	------------------------

SEMESTER – V/VI

PAPER – VII

Max. Marks 50

Lab List: Web Applications Development using PHP & MYSQL lab

No. of Hours per week: 3

External: 40

Internal: 10

Credits: 2

I. Course Outcomes: Students at the successful completion of the course will be able to:

CO1: Learn and implement basic programs in PHP, Control statements and functions concept (PO5)

CO2: Implement Basic programs in Object, various objects, Formatting strings, Date and time (PO5)

CO3: Learn and implement important programs of Forms, Combining HTML with PHP code. Importance of Cookies and Sessions..(PO5)

CO4: Implement programs on Files concept in PHP and on Image creation, drawing, and modification image (PO5 & PO7)

CO5: Implement Database programs on MySQLi, Connection, Creation of Database, Table adding Record into it related programs (PO7)

II: Practical (Laboratory) Syllabus: (30 Periods): At least 8 Practical's.

1. Write a PHP program to Display "Hello"
2. Write a PHP Program to display today's date.
3. Write a PHP program to display Fibonacci series.
4. Write a PHP Program to read the employee details.
5. Write a PHP program to prepare the student marks list.
6. Write a PHP program to generate the multiplication of two matrices.
7. Create student registration form using text box, check box, radio button, select, submit button. And display user inserted value in new PHP page.
8. Create Website Registration Form using text box, check box, radio button, select, submit button. And display user inserted value in the new PHP page.
9. Write a PHP script to demonstrate passing variables with cookies.
10. Write a program to keep track of how many times a visitor has loaded the page.
11. Write a PHP application to add, Modify, delete and fetch the rows in a Table.
12. Develop a PHP application to implement the following Operations
 - a. Registration of Users.
 - b. Insert the details of the Users.
 - c. Modify the Details.
 - d. Transaction Maintenance.

i.No of times Logged in (ii).Time Spent on each login. Ii. Restrict the user for three trials only.

iii. Delete the user if he spent more than 100 Hrs of transaction.

13. Write a PHP script to connect to the MySQL server from your website.
14. Write a program to read customer information like cust-no, cust-name, item purchased, and mob-no, from customer table and display all this information in table format on the output screen.
15. Write a program to edit the name of a customer to "Kiran" with cust-no =1, and to delete record with cust-no=3.
16. Write a program to read employee information like emp-no, emp-name, designation and salary from the EMP table and display all this information using table format in your website.
17. Create a dynamic web site using PHP and MySQL.

Textbooks and References: 1. JulieC.Meloni,SAMS Teach yourself PHP MySQL and Apache, Pearson Education(2007).

1. Steven Holzner, PHP: The Complete Reference, McGraw-Hill

2. RobinNixon, LearningPHP,MySQL,JavaScript,CSS&HTML5,ThirdEditionO'reilly.

Web resources: a.<http://www.codecademy.com/tracks/php>

b.<http://www.w3schools.com/PHP>

A.G & S.G.SIDDHARTHA DEGREE COLLEGE OF ARTS & SCIENCE

Vuyyuru-521165.NAAC reaccredited at 'A' level

Autonomous -ISO 9001 – 2015 Certified

Title of the Paper: INTERNET OF THINGS

Semester: V/VI

Course Code	SECCSCT03	Course Delivery Method	Class Room / Blended Mode - Both
Credits	3	CIA Marks	30
No. of Lecture Hours / Week	3	Semester End Exam Marks	70
Total Number of Lecture Hours	60	Total Marks	100
Year of Introduction :2022-23	Year of Offering: 2022 -23	Year of Revision: ----	Percentage of Revision: 0%

Course Objective: This course gives a foundation in the Internet of Things, including the components, tools, and analysis by teaching the concepts behind the IoT and a look at real-world solutions.

Course Outcomes: Students at the successful completion of the course will be able to:

CO ₁	Understand architecture and applications of IoT systems.(PO5)
CO ₂	Gain knowledge of various development boards used for IoT.(PO5)
CO ₃	Understand various Wireless Technologies used in IoT.(PO5)
CO ₄	Learn how to use various sensors and actuators for design of IoT.(PO7)
CO ₅	Learn how to connect various things to Internet and develop simple IOT Devices. (PO7)

Syllabus

Course Details

Unit	Learning Units	Lecture Hours
I	Fundamentals of IoT: Introduction, Definitions & Characteristics of IoT, IoT Architectures, Physical & Logical Design of IoT, Enabling Technologies in IoT, History of IoT, About Things in IoT, The Identifiers in IoT, About the Internet in IoT, IoT frameworks, IoT and M2M. Applications of IoT: Home Automation, Smart Cities, Energy, Retail Management, Logistics, Agriculture, Health and Lifestyle, Industrial IoT, Legal challenges, IoT design Ethics, IoT in Environmental Protection.	12
II	Sensors Networks: Definition, Types of Sensors, Types of Actuators, Examples and Working, IoT Development Boards: Arduino IDE and Board Types, Raspberry Pi Development Kit, RFID Principles and components, Wireless Sensor Networks: History and Context, The node, Connecting nodes, Networking Nodes, WSN and IoT.	12
III	Wireless Technologies for IoT: WPAN Technologies for IoT: IEEE802.15.4, Zigbee, HART, NFC, ZWave, BLE, Bacnet And Modbus. IP Based Protocols for IoT IPv6, 6LoWPAN, LoRA, RPL, REST, AMPQ, CoAP, MQTT. Edge connectivity and protocols.	14
IV	Arduino Simulation Environment: Arduino Uno Architecture, Setting up the IDE, Writing Arduino Software, Arduino Libraries, Basics of Embedded C programming for Arduino, Interfacing LED, push button and buzzer with Arduino, Interfacing Arduino with LCD. Sensor & Actuators with Arduino: Overview of Sensors working, Analog and Digital Sensors, Interfacing of Temperature, Humidity, Motion, Light and Gas Sensors with Arduino, Interfacing of Actuators with Arduino, Interfacing of Relay Switch and Servo Motor with Arduino.	12
V	Developing IOT's: Implementation of IoT with Arduino, Connecting and using various IoT Cloud Based Platforms such as Blynk, Thing speak, AWS IoT, Google Cloud IoT Core etc. Cloud Computing, Fog Computing, Privacy and Security Issues in IoT.	10

Text Book/References

1. Internet of things - A Hands-on Approach, Arshdeep Bahga and Vijay Madisetti, Universities Press, 2015, ISBN: 9788173719547
2. Vijay Madisetti and Arshdeep Bahga, "Internet of Things (A Hands-on Approach)", 1st Edition, VPT, 2014

Reference Materials on the Web/web-links:

1. <https://github.com/connectIOT/iottoolkit> 2. <https://github.com/connectIOT/iottoolkit> <https://www.arduino.cc/>
3. https://onlinecourses.nptel.ac.in/noc17_cs22/course 4. <https://blynk.io> (Mobile app)

AG & SG SIDDHARTHA COLLEGE OF ARTS AND SCIENCES - VUYURU.
An Autonomous college within the jurisdiction of Krishna University A.P, India.
(With Effect from Academic Year 2022-23)

COMPUTER SCIENCE	SECCSCT03	2022-23	B.SC(MPCS,MCCS)
-------------------------	------------------	----------------	------------------------

SEMESTER – V/VI

PAPER – VI

Max. Marks 70

Model Paper: Internet Of Things

NO of Hours: 3

No Of Credits: 3

Pass Marks 28

SECTION – A

Short Answer Questions

(4x5=20Marks)

Answer any Four questions. (At least 1 question should be given from each Unit)

- 1) Define IOT and write characteristics of IOT.(CO1,L1)
- 2) Differentiate IOT and M2M.(CO1,L4)
- 3) Define Actuator and explain about it.(CO2,L1)
- 4) Explain about wireless technology Zigbee.(CO3,L2)
- 5) Explain about light and gas sensors.(CO4,L2)
- 6) Write short note on Fog Computing.(CO5,L1)

SECTION B

(5x10=50Marks)

Answer all questions. (Two questions should be given from each unit with internal choice)

9 (a) Explain IOT architecture with neat diagram.(CO1,L2)

OR

9(b) Discuss about Applications of IOT.(CO1,L6)

10(a) List various types of sensors in IOT and explain any 3 of them.(CO2,L2)

OR

10(b) List RFID components and explain them..(CO2,L2)

11(a) Write names of wireless technologies used in IOT and describe any 2 of them.(CO3,L2)

OR

11(b) Compare and Contrast MQTT and CoAP protocols.(CO3,L4)

12(a) Explain Arduino Uno Architecture.(CO4,L2)

OR

12(b) Construct steps for Interfacing Arduino with LCD and explain them.(CO4,L3)

13(a) Discuss about Privacy and security issues in IOT.(CO5,L6)

OR

13(b) Write code to Design any App of your choice using Thingspeak.(CO5,L6)

AG & SG SIDDHARTHA COLLEGE OF ARTS AND SCIENCES - VUYYURU.

An Autonomous college within the jurisdiction of Krishna University A.P, India.

(With Effect from Academic Year 2022-23)

COMPUTER SCIENCE	SECCSCT03	2022-23	B.SC(MPCS,MCCS)
SEMESTER – V/VI	PAPER – VI		Max. Marks 50

Lab List: INTERNET OF THINGS LAB

No. of Hours per week: 2

External: 40

Internal: 10

Credits: 2

I. Course Outcomes: Students at the successful completion of the course will be able to:

CO1:Acquiretheskillsto design a small IoT device.(PO5)

CO2:Connectvariousensors, actuators, etc to Arduino board.(PO5)

CO3:Connectthethingsto Internet.(PO5)

CO4:Designasmallmobile app to control the sensors.(PO5,PO7)

CO5:Deployasimple IoT device.(PO5,PO7)

II: Practical (Laboratory) Syllabus: (30 Periods)

1. Understanding Arduino UNO Board and Components
2. Installing and work with Arduino IDE
3. Blinking LED sketch with Arduino
4. Simulationof4-WayTrafficLightwithArduino
5. Using Pulse Width Modulation
6. LEDF ade Sketch and Button Sketch
7. Analog Input Sketch(Bar Graph with LEDs and Potentiometre)
8. Digital Read Serial Sketch (Working with DHT/I R/Gas or Any other Sensor)
9. Working with Adafruit Librariesin Arduino
10. Spinninga DC Motorand Motor Speed Control Sketch
11. Working with Shields
12. Design APP using Blink Appor Thing speak API and connectit LED bulb.
13. Design APP Using Blynk Appand Connect to Temperature, magnetic Sensors.

II. Lab References:

1. Internet of Things - A Hands-on Approach, ArshdeepBahga and Vijay Madiseti,UniversitiesPress, 2015, ISBN: 9788173719547
2. Vijay Madiseti and Arshdeep Bahga, “Internet of Things (A Hands-on Approach)”, 1stEdition, VPT, 2014
3. DanielMinoli,—“BuildingtheInternetofThingswithIPv6andMIPv6:TheEvolvingWorldof M2MCommunications”,ISBN:978-1-118-47347-4,WillyPublications

Reference Materials on the Web/web-links:

1. <https://github.com/connectIOT/iottoolkithttps://www.arduino.cc/>
2. https://onlinecourses.nptel.ac.in/noc17_cs22/course
3. <https://blynk.io>(Mobileapp)

A.G & S.G.SIDDHARTHA DEGREE COLLEGE OF ARTS & SCIENCE

Vuyyuru-521165.NAAC recredited at 'A' level

Autonomous -ISO 9001 – 2015 Certified

Title of the Paper: APPLICATION DEVELOPMENT USING PYTHON

Semester: V/VI

Course Code	SECCSCT04	Course Delivery Method	Class Room / Blended Mode - Both
Credits	3	CIA Marks	30
No. of Lecture Hours / Week	3	Semester End Exam Marks	70
Total Number of Lecture Hours	60	Total Marks	100
Year of Introduction :2022-23	Year of Offering: 2022 -23	Year of Revision: ----	Percentage of Revision: 0%

Course Objective: To further your software development career, you need to understand why and how Python executes your code so that you can create clean code that compiles in time. This Course unleashes the power of Python's functionalities to create compelling applications!

Course Outcomes: Students at the successful completion of the course will be able to:

CO ₁	Understand basics of python and write applications using strings, tuples, lists, sets.(PO5,PO7)
CO ₂	Understand and use exceptions and packages for different applications.(PO5,PO7)
CO ₃	Create, run and manipulate Python Programs using threads and Regular Expressions.(PO5,PO7)
CO ₄	Apply concepts of Python programming in various fields related to IOT, Web Services and Databases in Python.(PO5,PO7)
CO ₅	write applications in python to perform various database operations.(PO5,PO7)

Syllabus

Course Details

Unit	Learning Units	Lecture Hours
I	Python basics, Objects- Python Objects, Standard Types, Other Built-in Types, Internal Types, Standard Type Operators, Standard Type Built-in Functions, Sequences- Strings, Lists, and Tuples, Mapping and Set Types. Numbers- Introduction to Numbers, Integers, Floating Point Real Numbers, Complex Numbers, Operators, Related Modules.	12
II	Files: File Objects, File Built-in Function [open()], File Built-in Methods, File Built-in Attributes, Command-line Arguments, File System, File Execution, Persistent Storage Modules, Related Modules. Exceptions: Exceptions in Python, Detecting and Handling Exceptions, Context Management, Exceptions as Strings, Raising Exceptions, Assertions, Standard Exceptions , Creating Exceptions. Modules: Modules and Files, Name spaces ,Importing Modules, Importing Module Attributes ,Module Built-in Functions ,Packages.	12
III	Regular Expressions: Introduction , Special Symbols and Characters, Resand Python Multithreaded Programming: Introduction, Threads and Processes, Python, Threads, and the Global Interpreter Lock, Thread Module, Threading Module.	14
IV	GUI Programming: Introduction, Tkinter and Python Programming, Brief Tour of Other GUIs, Related Modules and Other GUIs. Web Programming: Introduction, Web Surfing with Python, Creating Simple Web Clients, Advanced Web Clients, CGI Helping Servers Process Client Data, Building CGI Application, Web (HTTP) Servers.	12
V	DatabaseProgramming: Introduction,PythonDatabaseApplicationProgrammer'sInterface (DBAPI), Object Relational Managers(ORMs).	10

Text Book/References:1ThinkPython,AllenDowney,GreenTeaPress.

- 2.IntroductiontoPython, KennethA. Lambert, Cengage.
- 3.PythonProgramming:A Modern Approach, Vamsi Kurama ,Pearson.
- 4.LearningPython,Mark Lutz, O' Really.
- 5.Core Python Programming, WesleyJ. Chun,Second Edition, Pearson

Reference Materials on the Web/web-links:

- <https://www.tutorialspoint.com/python/index.htm>
- <https://www.w3schools.com/python/>

AG & SG SIDDHARTHA COLLEGE OF ARTS AND SCIENCES - VUYYURU.
An Autonomous college within the jurisdiction of Krishna University A.P, India.
(With Effect from Academic Year 2022-23)

COMPUTER SCIENCE	SECCSCT04	2022-23	B.SC(MPCS,MCCS)
-------------------------	------------------	----------------	------------------------

SEMESTER – V/VI

PAPER – VII

Max. Marks 70

Model Paper: Application Development Using Python

NO of Hours: 3

No Of Credits: 3

Pass Marks 28

SECTION – A

Short Answer Questions

(4 x 5=20Marks)

Answer any Four questions. (At least 1 question should be given from each Unit)

- 1) Give classification of various built in data types in python .(CO1,L2)
- 2) Compare tuples and sets in python.(CO1,L4)
- 3) What is need of assertions in python? Give simple example.(CO2,L1)
- 4) Write 5 special symbols used in python and their purpose.(CO3,L1)
- 5) Write short note on web surfing with python.(CO4,L1)
- 6) Why do we use Global Interpreter lock in Python?(CO5,L1)

SECTION B

(5 x 10=50 Marks)

Answer all questions. (Two questions should be given from each unit with internal choice)

9 (a) Write names of ten built in functions in python and explain them.(CO1,L2)

OR

9(b) Create a list in python and apply five list methods on it.(CO1,L6)

10(a) Create a program in python to demonstrate exception handling.(CO2,L6)

OR

10(b) Develop a program in python for user defined module creation and importing.(CO2,L6)

11(a) Develop multithreaded program in python.(CO3,L6)

OR

11(b) Explain about threading module with an example program.(CO3,L2)

12(a) Discuss with steps building CGI application in Python.(CO4,L6)

OR

12(b) Explain with example creating simple web client in python.(CO4,L6)

13(a) Explain about Python database Application programmers interface.(CO5,L2)

OR

13(b) Create database application in python to insert and delete student records.(CO5,L6).

AG & SG SIDDHARTHA COLLEGE OF ARTS AND SCIENCES - VUYYURU.
 An Autonomous college within the jurisdiction of Krishna University A.P, India.
 (With Effect from Academic Year 2022-23)

COMPUTER SCIENCE	SECCSCT04	2022-23	B.SC(MPCS,MCCS)
-------------------------	------------------	----------------	------------------------

SEMESTER – V/VI PAPER – VII Max. Marks 50

Lab List: **APPLICATION DEVELOPMENT USING PYTHON LAB**

No. of Hours per week: 2 External: 40 Internal: 10 Credits: 2

I. Course Outcomes: Students at the successful completion of the course will be able to:

CO1: Acquire the skill to write simple programs in python. (PO5, PO7)

CO2: Implement programs related to various data structures like lists, set, etc. (PO5, PO7)

CO3: Implement programs related to files. (PO5, PO7)

CO4: Implement Exception handling programs in python. (PO5, PO7)

CO5: Implement programs to insert, delete, display data in databases. (PO5, PO7)

II: Practical (Laboratory) Syllabus: (30 Periods)

1. Write a menu driven program to convert the given temperature from Fahrenheit to Celsius and vice versa depending up on user's choice.
2. Write a python program to calculate total marks, percentage and grade of a student. Marks obtained in each of the three subjects are to be input by the user. Assign grades according to the following criteria:

Grade A: Percentage ≥ 80 **Grade B:** Percentage ≥ 70 and < 80 **Grade C:** Percentage ≥ 60 and < 70

Grade D: Percentage ≥ 40 and < 60 **Grade E:** Percentage < 40

3. Write a python program to display the first n term of Fibonacci series.
4. Write a python program to calculate the sum and product of two compatible matrices.
5. Write a function that takes a character and returns True if it is a vowel and False otherwise.
6. Write a menu-driven program to create mathematical 3D objects
 1. Curve 2. sphere 3. cone 4. arrow 5. ring 6. Cylinder.
7. Write a python program to read integers and display them as a histogram.
8. Write a python program to display sine, cosine, polynomial and exponential curves.
9. Write a python program to plot a graph of people with pulse rate p vs. height h. The values of P and H are to be entered by the user.
10. Write a python program to calculate the mass m in a chemical reaction. The mass m (in gms) disintegrates according to the formula $m = 60 / (t + 2)$, where t is the time in hours. Sketch a graph for t vs. m, where $t \geq 0$.
11. A population of 1000 bacteria is introduced into a nutrient medium. The population grows as follows: $P(t) = (15000(1+t)) / (15+e)$
12. Where the time t is measured in hours. WAP to determine the size of the population at given time t and plot a graph for P vs t for the specified time interval.
13. Input initial velocity and acceleration, and plot the following graphs depicting equations of motion: 1. Velocity wrt time ($v = u + at$) 2. Distance wrt time ($s = ut + 0.5 * a * t^2$)
 Distance wrt velocity ($s = (v^2 - u^2) / 2 * a$)
14. Write a program that takes two lists and returns True if they have at least one common member.

15. Write a Python program to print a specified list after removing the 0th, 2nd, 4th and 5th elements.
16. Write a program to implement exception handling.
17. Try to configure the widget with various options like: `bg="green", family="times", size=20`.
18. Write a Python program to read last 5 lines of a file.
19. Design a simple database application that stores the records and retrieve the same.
20. Design a database application search the specified record from the database.
21. Design a database application to that allows the user to add, delete and modify the records.

III. Lab References:

1. Core Python Programming, Wesley J. Chun, Second Edition, Pearson.
2. Think Python, Allen Downey, Green Tea Press.

Reference Materials on the Web/web-links:

- <https://www.tutorialspoint.com/python/index.htm>
- <https://www.w3schools.com/python/>

A.G & S.G.SIDDHARTHA DEGREE COLLEGE OF ARTS & SCIENCE

Vuyyuru-521165.NAAC reaccruited at 'A' level

Autonomous -ISO 9001 – 2015 Certified

Title of the Paper: DATA SCIENCE

Semester: V/VI

Course Code	SECCSCT05	Course Delivery Method	Class Room / Blended Mode - Both
Credits	3	CIA Marks	30
No. of Lecture Hours / Week	3	Semester End Exam Marks	70
Total Number of Lecture Hours	60	Total Marks	100
Year of Introduction :2022-23	Year of Offering: 2022 -23	Year of Revision: ----	Percentage of Revision: 0%

Course Objective: Develop in depth understanding of the key technologies in data science and business analytics: data mining, machine learning, visualization techniques, predictive modeling, and statistics. Practice problem analysis and decision-making.

Course Outcomes: Students at the successful completion of the course will be able to:

CO ₁	Analyze the data and their type to build programs using lists and tuples in Python.(PO5)
CO ₂	Understand the concept of getting data, cleaning and manipulating data(PO5)
CO ₃	Be capable of understanding the concepts of K-Nearest Neighbors, Naïve Baye's.(PO5,PO7)
CO ₄	Understand the concepts of Simple, Multiple & Logistic regressions.(PO5,PO7)
CO ₅	Acquire knowledge on Decision Trees and Neural Networks.(PO5,PO7)

Syllabus

Course Details

Unit	Learning Units	Lecture Hours
I	Introduction: The Ascendance of Data, What is Data Science?, Finding key Connectors- Data Scientists You May Know, Salaries and Experience - Paid Accounts ,Topics of Interest, Onward. Python: Getting Python, The Zen of Python, Whitespace Formatting, Modules , Arithmetic, Functions, Strings, Exceptions, Lists, Tuples, Dictionaries, Sets, Control Flow, Truthiness, Sorting, List Comprehensions. Visualizing Data : Matplotlib, Bar charts, Line charts ,Scatterplots	12
II	Getting Data: stdin and stdout, Reading Files – The Basics of Text Files, Delimited Files, Scraping the Web - HTML and the parsing Thereof, Example: O’Reilly Books about Data, Using APIs – JSON (and XML), Using an Unauthenticated API, Finding APIs. Working with Data : Exploring Your Data, Exploring One-Dimensional Data, Two Dimensions Many Dimensions ,Cleaning and Munging, Manipulating Data ,Rescaling, Dimensionality Reduction.	12
III	Machine Learning: Modeling, What Is Machine Learning? Over fitting and under fitting, Correctness, The Bias-Variance Trade-off, Feature Extraction and Selection. K-Nearest Neighbors: The Model, Example: Favorite Languages, The Curse of Dimensionality. Naive Bayes : A Really Dumb Spam Filter, A More Sophisticated Spam Filter, Implementation, Testing Our Model.	14
IV	Simple Linear Regression: The Model, Using Gradient Descent, Maximum Likelihood Estimation. Multiple Regression: The Model, Further Assumptions of the Least Squares Model, Fitting the Model, Interpreting the Model, Goodness of F. LogisticRegression: The Problem, the Logistic Function, Applying the Model, Goodness of Fit Support Vector Machines.	12
V	Decision Trees: What Is a Decision Tree? Entropy, the Entropy of a Partition, Creating a Decision Tree, Putting It All Together, Random Forests. Neural Networks: Perceptron, Feed-Forward Neul Networks and Back propagation,Example: Defeating a CAPTCHA.	10

References/ Text Book/ e-books/websites

Text Books:

1. Data Science from Scratch by Joel Grus O’ReillyMedia
2. Wes McKinney, “Python for Data Analysis: Data Wrangling with Pandas, NumPy, and IPython”, O’Reilly, 2nd Edition,2018.

Reference Books:

1. Jake VanderPlas, “Python Data Science Handbook: Essential Tools for Working with Data”, O’Reilly,2017.

Webresources:<https://www.edx.org/course/analyzing-data-with-python>

[http://math.ecnu.edu.cn/~lfzhou/seminar/\[Joel Grus\] Data Science from Scratch First Princ.pdf](http://math.ecnu.edu.cn/~lfzhou/seminar/[Joel Grus] Data Science from Scratch First Princ.pdf)

AG & SG SIDDHARTHA COLLEGE OF ARTS AND SCIENCES - VUYYURU.
An Autonomous college within the jurisdiction of Krishna University A.P, India.
(With Effect from Academic Year 2022-23)

COMPUTER SCIENCE	SECCSCT05	2022-23	B.SC(MPCS,MCCS)
-------------------------	------------------	----------------	------------------------

SEMESTER – V/VI

PAPER – VI

Max. Marks 70

Model Paper: Data Science

NO of Hours: 3

No Of Credits: 3

Pass Marks 28

SECTION – A

Short Answer Questions

(4 x 5=20Marks)

Answer any Four questions. (At least 1 question should be given from each Unit)

1. What is Data Science? Explain key connectors in data science? (CO1, L1)
2. Explain a) stdin b) stdout with examples? (CO2, L2)
3. Explain Simple Linear Regression using Gradient Descent? (CO4, L2)
4. Explain briefly about Logistic Regression? (CO5, L2)
5. Explain a) Lists b) Tuples c) Dictionaries in Python? (CO1, L2)
6. Explain in detail about Manipulating data? (CO3, L2)

SECTION B

Answer all questions.

(5 x 10 = 50 Marks)

9. (A) Explain in detail about Visualizing Data? (CO1, L2)
(OR)
(B) Explain the concept of functions and strings in python with example? (CO1, L2)
10. (A) Explain the concept of reading files? (CO3, L2)
(OR)
(B) Explain about Exploring One-Dimensional and Two- Dimensional data? (CO3, L2)
11. (A) Explain Machine learning with over fitting and under fitting in detail? (CO3, L2).
(OR)
(B) Explain K- Nearest Neighbors Model with an example? (CO4, L2)
12. (A) Explain Maximum Likelihood Estimation with example? (CO4, L2)
(OR)
(B) Explain in detail about Multiple Regression Model? (CO4, L2)
13. (A) Explain in detail about the concept of Decision Trees? (CO5, L2)
(OR)
(B) Explain the concept of Neural Networks with an example? (CO5, L2)

AG & SG SIDDHARTHA COLLEGE OF ARTS AND SCIENCES - VUYYURU.
 An Autonomous college within the jurisdiction of Krishna University A.P, India.
 (With Effect from Academic Year 2022-23)

COMPUTER SCIENCE	SECCSCT05	2022-23	B.SC(MPCS,MCCS)
SEMESTER – V/VI	PAPER – VI	Max. Marks 50	

Lab List: **Data Science LAB**

No. of Hours per week: 3 External: 40 Internal: 10 Credits: 2

I. Course Outcomes: Students at the successful completion of the course will be able to:

- CO1: Implement the programs to get the required data, process it and present the outputs using Python language.(PO5)
- CO2: Execute statistical analyses with Open-source Python software.(PO5)
- CO3: Apply data science solutions to real world problems.(PO5)
- CO4: Implement Plot Distribution Curve in Python.(PO5)
- CO5: Implement rainfall data importing of some location with the help of packages available in R Studio and plot a chart of your choice.(PO5)

II: Practical (Laboratory) Syllabus: (30 Periods).

LAB EXERCISES

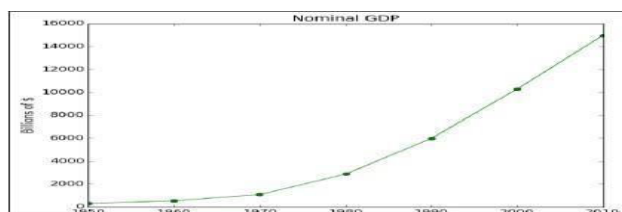

3. **Practical (Laboratory) Syllabus: (30hrs.)**
4. Write a Python program to create a line chart for values of year and GDP as given below.
5. Write a Python program to create a bar chart to display number of students secured different grading as given below



6. Write a Python program to create a time series chart by taking one year month wise stock data in a CSV file
7. Write a Python program to plot distribution curve
8. Import a CSV file and perform various Statistical and Comparison operations on rows/columns. Write a python program to plot a graph of people with pulse rate pvs. height h. The values of P and H are to be entered by the user.
9. Import rainfall data of some location with the help of packages available in R Studio and plot a chart of your choice.

Lab References: 1.Data Science from Scratch by Joel Grus O'Reilly Media

2.Wes McKinney, "Python for Data Analysis: Data Wrangling with Pandas, Num Py, and I Python", O'Reilly, 2nd Edition,2018.

Reference Materials on the Web/web:

- a. [https://swcarpentry.github.io/python-novice-gapminder/09-plotting/index.html /](https://swcarpentry.github.io/python-novice-gapminder/09-plotting/index.html/)
- b. <https://www.geeksforgeeks.org/visualize-data-from-csv-file-in-python/>

A.G & S.G.SIDDHARTHA DEGREE COLLEGE OF ARTS & SCIENCE

Vuyyuru-521165.NAAC reaccredited at 'A' level

*Autonomous -ISO 9001 – 2015 Certified***Title of the Paper: PYTHON FOR DATASCIENCE****Semester: V/VI**

Course Code	SECCSCT06	Course Delivery Method	Class Room / Blended Mode - Both
Credits	3	CIA Marks	30
No. of Lecture Hours / Week	3	Semester End Exam Marks	70
Total Number of Lecture Hours	60	Total Marks	100
Year of Introduction :2022-23	Year of Offering: 2022 -23	Year of Revision: ----	Percentage of Revision: 0%

Course Objective: The main objective of the course is to provide students with the basic concepts of Python, its syntax, functions and packages to enable them to write scripts for data manipulation and analysis. The course develops skills of writing and running a code using Python.

Course Outcomes: Students at the successful completion of the course will be able to:

CO ₁	Identify the need for data science and solve basic problems using Python built-in data types and their methods.(PO5)
CO ₂	Design an application with user-defined modules and packages using OOP concepts.(PO5)
CO ₃	Deploy efficient storage and data operations using NumPy arrays.(PO5)
CO ₄	Apply powerful data manipulations using Pandas.(PO5)
CO ₅	Do data pre-processing and visualization using Pandas.(PO5,PO7)

Syllabus

Course Details

Unit	Learning Units	Lecture Hours
I	Basics of python programming-Features of Python, History of Python, Literal constants, Data Types, Input Operation, Reserved words, Operators and Expressions, Other Data Types, Lists, Dictionary, Type Conversion.	12
II	Decision Control Statements- Selection/conditional branching statements, Basic Loop Structures/Iterative Statements, Functions and Modules-Introduction, Function Definition, Function Call, Modules- Packages in Python, Python strings Revisited, Introduction, Built in String methods and functions, File Handling-Introduction, Opening and closing Files, Reading and writing Files, Directory Methods	12
III	Classes and Objects- Introduction, Classes and Objects, Class method and self argument, The init() method(the class constructor), Inheritance- Introduction, Inheriting classes in python, Types of Inheritance, Error and Exception Handling-Introduction to errors and exceptions, Handling Exceptions, Multiple except blocks ,NumPy Basics- Arrays and Vectorized Computation, The NumPyndarray, Creating ndarrays, Data Types for ndarrays, Arithmetic with NumPy Arrays, Basic Indexing and Slicing, Boolean Indexing, Transposing Arrays and Swapping Axes.	14
IV	Universal Functions: Fast Element, Wise Array Functions, Mathematical and Statistical Methods, Sorting, Unique and Other Set Logic, Introduction to pandas Data Structures-Series, Data Frame and Essential Functionality, Dropping Entries- Indexing, Selection, and Filtering, Function Application and Mapping, Sorting and Ranking.	12
V	Summarizing and Computing Descriptive Statistics, Unique Values, Value Counts, and Membership, Reading and Writing Data in Text Format, Data Cleaning and Preparation: Handling Missing Data, Data Transformation: Removing Duplicates, Transforming Data Using a Function or Mapping, Replacing Values, Detecting and Filtering Outliers, String Manipulation- Vectorized String Functions in pandas.	10

References/ Text Book/ e-books/websites

Text Books:

1. Reemathareja—Python Programming using problem solving approach, Oxford Publication
2. Wes McKinney, “Python for Data Analysis: Data Wrangling with Pandas, NumPy, and IPython”, O’Reilly, 2nd Edition, 2018.

Reference Books:

1. Jake VanderPlas, “Python Data Science Handbook: Essential Tools for Working with 2.Data”, O’Reilly, 2017.
3. Wesley J. Chun, “Core Python Programming”, Prentice Hall, 2006.
4. Mark Lutz, “Learning Python”, O’Reilly, 4th Edition, 2009.

Reference Materials on the Web/web-links:

- a. <https://www.edx.org/course/python-basics-for-data-science>
- b. <https://www.edx.org/course/analyzing-data-with-python>
- c. <https://www.coursera.org/learn/python-plotting?specialization=data-science-python>
- d. <https://www.programmer-books.com/introducing-data-science-pdf/>

AG & SG SIDDHARTHA COLLEGE OF ARTS AND SCIENCES - VUYYURU.
An Autonomous college within the jurisdiction of Krishna University A.P, India.
(With Effect from Academic Year 2022-23)

COMPUTER SCIENCE	SECCSCT06	2022-23	B.SC(MPCS,MCCS)
-------------------------	------------------	----------------	------------------------

SEMESTER – V/VI

PAPER – VII

Max. Marks 70

Model Paper: : PYTHON FOR DATASCIENCE

NO of Hours: 3

No Of Credits: 3

Pass Marks 28

SECTION – A

Short Answer Questions

(4 x 5=20Marks)

Answer any Four questions. (At least 1 question should be given from each Unit)

- 1) State any four applications where python is more popular(CO1,L1)
- 2) List out the main differences between lists and tuples.(CO1,L2)
- 3) What are the uses of File object?(CO2,L1)
- 4) Differentiate between an error and exception(CO3,L3)
- 5) Write Array Functions(CO4,L1)
- 6) How to read and write data in text format(CO5,L4)

SECTION - B

(5 x 10=50Marks)

Answer all questions. (Two questions should be given from each unit with internal choice)

9 .(a). Write in brief about the applications of Python.(CO1,L1)

OR

(b). Explain Various data types in python with Examples(CO2,L2)

10 (a). List different conditional statements in python with appropriate examples.(CO2,L2)

OR

(b). Explain the following file built-in functions and method with clear syntax, description and illustration: a) open () b) file () c) seek () d) tell () e)read ()(CO3,L2)

11 (a). How does try-except statement work? Demonstrate with an example python code. (CO3,L4)

OR

(b). Explain NumPy arrays with suitable example(CO3,L2)

12 (a). Write Briefly Pandas Data structure(CO4,L1)

OR

(b). Write a python program to read data from CSV files using pandas(CO4,L1)

13 (a). How to remove duplicates from data transformation(CO5,L4)

OR

(b). Explain Python for Data Visualisation(CO5,L2).

AG & SG SIDDHARTHA COLLEGE OF ARTS AND SCIENCES - VUYYURU.

An Autonomous college within the jurisdiction of Krishna University A.P, India.

(With Effect from Academic Year 2022-23)

COMPUTER SCIENCE	SECCSCT06	2022-23	B.SC(MPCS,MCCS)
------------------	-----------	---------	-----------------

SEMESTER – V/VI

PAPER – VII

Max. Marks 50

Lab List: **PYTHON FOR DATA SCIENCE LAB**

No. of Hours per week: 3

External: 40

Internal: 10

Credits: 2

I. Course Outcomes: Students at the successful completion of the course will be able to:

CO1: Understand the basic concepts of python programs and perform List, Tuple and Dictionary(PO5,PO7)

CO2: Understand the program of functions (PO5,PO7)

CO3: Able to Understand file handling techniques.(PO5,PO7)

CO4: Understand concepts of OOPS (PO5,PO7)

CO5: Able to Solving of data frames (PO5,PO7)

II: Practical (Laboratory) Syllabus: (30 Periods)

1. Perform Creation, indexing, slicing, concatenation and repetition operations on Python built-in data types: Strings, List, Tuples, Dictionary
2. Apply Python built-in data types: List, Tuples, Dictionary and their methods to solve any given problem.
3. Handle numerical operations using math and random number functions
4. Create user-defined functions with different types of function arguments.
5. Create packages and import modules from packages.
6. Perform File manipulations- open, close, read, write, append and copy from one file to another.
7. Write a program for Handle Exceptions using Python Built-in Exceptions
8. Write a program to implement OOP concepts
9. Create NumPy arrays from Python Data Structures, Intrinsic NumPy objects and Random Functions.
10. Manipulation of NumPy arrays- Indexing, Slicing, Reshaping, Joining and Splitting.
11. Computation on NumPy arrays using Universal Functions and Mathematical methods.
12. Load an image file and do crop and flip operation using NumPy Indexing.
13. Create Pandas Series and Data Frame from various inputs.
14. Import any CSV file to Pandas Data Frame and perform the following:
 - (a) Visualize the first and last 10 records
 - (b) Get the shape, index and column details
 - (c) Select/Delete the records (rows)/columns based on conditions.
 - (d) Perform ranking and sorting operations.
 - (e) Do required statistical operations on the given columns.
 - (f) Find the count and uniqueness of the given categorical values.
 - (g) Rename single/multiple columns
15. Import any CSV file to Pandas Data Frame and perform the following:
 - (a) Handle missing data by detecting and dropping/ filling missing values.
 - (b) Transform data using apply () and map() method.
 - (c) Detect and filter outliers.
 - (d) Perform Vectorized String operations on Pandas Series.

III. Lab References: Wesley J. Chun, “Core Python Programming”, Prentice Hall, 2006. Jake Vander Plas, “Python Data Science Handbook: Essential Tools for Working with Data”, O’Reilly, 2017.

Reference Materials on the Web/web-links:

<https://www.coursera.org/learn/python-plotting?specialization=data-science-python>

A.G & S.G.SIDDHARTHA DEGREE COLLEGE OF ARTS & SCIENCE

Vuyyuru-521165.NAAC recredited at 'A' level

*Autonomous -ISO 9001 – 2015 Certified***Title of the Paper: BIG DATA ANALYTICS USING R****Semester: V/VI**

Course Code	SECCAT01	Course Delivery Method	Class Room / Blended Mode – Both
Credits	3	CIA Marks	30
No. of Lecture Hours / Week	3	Semester End Exam Marks	70
Total Number of Lecture Hours	60	Total Marks	100
Year of Introduction :2022-23	Year of Offering: 2022-23	Year of Revision: ----	Percentage of Revision: 0%

Course Objective: Big data analytics examines large amounts of data to uncover hidden patterns, correlations and other insights. With today's technology, it's possible to analyze your data and get answers from it almost immediately – an effort that's slower and less efficient with more traditional business intelligence solutions.

Course Outcomes:

CO ₁	Understand data and classification of digital data. (PO5)
CO ₂	Gain knowledge of technologies used in bigdata Analytics. (PO5, PO7)
CO ₃	Understand basics of R and control structures in R. (PO5)
CO ₄	Load data into R objects and manipulate them as needed. (PO5)
CO ₅	Create and edit visualizations with R (PO7)

Syllabus

Course Details

Unit	Learning Units	Lecture Hours
I	Introduction to Big data: What is data, Classification of Digital Data-Structured Unstructured, semi-structured data, Characteristics of data, Evaluation of big data, Definition and challenges of big data, what is big data and why to use big data?	12
II	Big data Analytics: What is and isn't big data analytics? Classification of analytics, Importance of big data analytics, Technologies needed to meet challenges of big data, data science, Data scientist	12
III	Introduction to R and getting started with R: What is R? Why R? Advantages of R over other programming languages, Data types in R - logical, numeric, integer, character, double, Complex, raw, coercion, ls () command, Expressions, Variables and functions, control structures, Array, Matrix, Vectors, Factors, R packages	14
IV	Exploring data in R– Data frames-data frame access, Ordering data frames, functions for data frames dim(), nrow(), ncol(), str(), summary(), names(), head(), tail(), edit(), Load data frames—reading from .CSV files, Sub setting data frames, reading from tab separated value files, Reading from tables, merging data frames	12
V	Data Visualization using R: Reading and getting data into R (External Data),Using CSV files, XML files, Web Data, JSON files, Databases, Excel files, Working with R Charts and Graphs: Histograms, Boxplots, Bar Charts, Line Graphs, Scatter plots, Pie Chart	10

Prescribed Text Book:

1. Seema Acharya--Data Analytics using R, McGraw Hill education (India) Private Limited.
2. Big Data Analytics, Introduction to Hadoop, Spark, and Machine-Learning, Raj Kamal, PreetiSaxena, McGraw Hill, 2018

Reference Books:

1. SeemaAcharya, SubhashiniChellappan --- Big Data and Analytics second edition, Wiley
2. Big Data, Big Analytics: Emerging Business intelligence and Analytic trends for Today's Business, Michael Minnelli, Michelle Chambers, and AmbigaDhiraj, John Wiley & Sons, 2013
3. An Introduction to R, Notes on R: A Programming Environment for Data Analysis and Graphics. W. N. Venables, D.M. Smith and the R Development Core Team

Course Focus: R for data science focuses on the language's statistical and graphical uses. When you learn R for data science, you'll learn how to use the language to perform statistical analyses and develop data visualizations. R's statistical functions also make it easy to clean, import and analyze data.

AG & SG SIDDHARTHA COLLEGE OF ARTS AND SCIENCES - VUYYURU.
An Autonomous college within the jurisdiction of Krishna University A.P, India.
(With Effect from Academic Year 2020-21)

COMPUTER SCIENCE	SECCAT01	2022-23	B.COM (CA)
-------------------------	-----------------	----------------	-------------------

SEMESTER – V/VI

PAPER – IV

Max. Marks 70

Model Paper: **BIGDATA ANALYTICS USING R**

NO of Hours: 3

No Of Credits: 3

Pass Marks 28

Section-A

Answer any Four questions.

(At least 1 question should be given from each Unit)

(4 x 5=25Marks)

1. What is big data and why to use a big data? (CO1, L1)
2. What is big data analytics? (CO2, L1)
3. Explain ls () command in R. (CO3, L2)
4. Write a short note on charts. (CO5, L1)
5. Develop R script to load data into data frames from files. (CO4, L6)
6. Write about the control structures in R with examples. (CO3, L1)

Section-B

Answer all questions.

(5X10=50Marks)

(Two questions should be given from each unit with internal choice)

9.(a) Give Classification of Digital Data and explain it. (CO1, L2)

OR

(b) Explain Characteristics of Data with an example. (CO1, L2)

10.(a) Write about Importance of big Data Analytics. (CO2, L1)

OR

(b) Explain Classification of Analytics. (CO2, L2)

11.(a) Write about the Data types in Explain with examples. (CO3, L1)

OR

(b) Construct Vector in R and explain various operations on it. (CO3, L3)

12. (a) What are the data frames? Write its significance in R-Language. (CO4, L1)

OR

(b) Demonstrate various functions used in data frames. (CO4, L2)

13.(a) Build a code in R for reading and getting data into R from databases. (CO5, L6)

OR

(b) Develop below plots in R (CO5, L6)

- a) Box Whisker plots b) Scatter plots c) Pairs plots

AG & SG SIDDHARTHA COLLEGE OF ARTS AND SCIENCES - VUYYURU.

An Autonomous college within the jurisdiction of Krishna University A.P, India.

(With Effect from Academic Year 2020-21)

COMPUTER SCIENCE	SECCAT01	2022-23	B.COM (CA)
SEMESTER – V	PAPER – VI		Max. Marks 50

Title: **BIG Data Analysis using Python lab**

No. of Hours per week: 3 External: 40 Internal: 10 Credits: 2 Pass Marks 20

I. Course Outcomes: Students at the successful completion of the course will be able to:

CO1: Implement simple scripts or programs in R. (PO5)

CO2: Access online resources for R and import new function packages into the R workspace. (PO5, PO7)

CO3: Import, review, manipulate and summarize data-sets in R (PO5, PO7)

CO4: Explore data-sets to create testable hypotheses and identify appropriate statistical tests. (PO5, PO7)

CO5: Create and edit visualizations with R. (PO5, PO7)

II: Practical (Laboratory) Syllabus: (30 Periods)

1. Create a vector in R and perform operations on it (arithmetic operations, combining Vectors, retrieving elements of vector, assign names to vector elements).
2. Create integer, complex, logical, character data type objects in R and print their values And their class using print and class functions.
3. Create a matrix of values in R and extract data from matrix. (Ex. Second row thirdetc.) find transpose of matrix and combine two matrices using Rbind and Cbind functions.
4. Create a list in R and perform operations on it like list slicing, sum and mean functions, head and tail functions and finally delete list using rm() function.
5. Create data frame in R and perform operations on it
6. Write code in R to find out whether a number is prime or not.
7. Print numbers from 1 to 100 using while loop and for loop in R.
8. Find the factorial of a number using recursion in R.
9. Perform arithmetic operations in R using switch case
10. Write a code in R to find out whether the number is Armstrong or not.
11. Program to find Multiplication table from 1 to 10 number input by user.
12. Import data into R from text and excel files using read.table() and read.csv() function.
13. Create a dataset and draw different types of graphics using plot, box plot, histogram, pair plot functions.
14. Create a dataset and draw different types of graphs using bar charts, pie chart functions.
15. Create custom contingency in R and perform operations on it.

III. Lab References:

1. Seema Acharya--Data Analytics using R, McGraw Hill education (India) Private Limited.
2. Big Data Analytics, Introduction to Hadoop, Spark, and Machine-Learning, Raj kamal, PreetiSaxena, McGraw Hill, 2018

Reference Materials on the Web/web-links:

1. <https://www.wiley.com/enbd/Big+Data.+Big+Analytics:+Emerging+Business+Intelligence+and+Analytic+Trends+for+Today's+Businesses-p-9781118147603>

A.G & S.G.SIDDHARTHA DEGREE COLLEGE OF ARTS & SCIENCE

Vuyyuru-521165.NAAC reaccredited at 'A' level

Autonomous -ISO 9001 – 2015 Certified

Title of the Paper: Data Science using Python

Semester: V/VI

Course Code	SECCAT02	Course Delivery Method	Class Room / Blended Mode – Both
Credits	3	CIA Marks	30
No. of Lecture Hours / Week	3	Semester End Exam Marks	70
Total Number of Lecture Hours	60	Total Marks	100
Year of Introduction :2022-23	Year of Offering: 2022 - 23	Year of Revision: ---	Percentage of Revision: 0%

Course Objective: The main objective of the course is to provide students with the basic concepts of Python, its syntax, functions and packages to enable them to write scripts for data manipulation and analysis. The course develops skills of writing and running a code using Python.

Course Outcomes: Students at the successful completion of the course will be able to:

CO ₁	Understand the need and importance of data science.(PO5,PO7)
CO ₂	Understand basic concepts of python and implementing control structures in python.(PO5)
CO ₃	Implement strings and other data structures in python(PO5,PO7)
CO ₄	Learn and Implement functions and modules in python.(PO5)
CO ₅	Learn and Implement data cleaning and plotting using pandas.(PO5,PO7)

Syllabus

Course Details

Unit	Learning Units	Lecture Hours
I	INTRODUCTION TODATA SCIENCE Data science and its importance, Advantages of data science, The process of data science , Responsibilities of a data scientist, Qualifications of data scientists, Would you be a good data scientist?, Why to use python for data science?	12
II	INTRODUCTION TO PYTHON What is python?, Features of python, History of python, Writing and executing the python program, Basic syntax, Variables, Keywords, Data types , Operators, Indentation, Control Structures-Conditional statements—If, If-else, Nested if-else, Looping statements—For, While, Nested Loops, Break, Continue, Pass	12
III	STRINGS AND DATA STRUCTURES Strings - definition, accessing, slicing and basic operations, Lists - introduction, accessing list, operations, working with lists, functions and methods, Tuples - introduction, accessing tuple, operations, Dictionaries- introduction, accessing values in dictionaries, working with dictionaries.	14
IV	FUNCTIONSANDMODULES Functions- Defining a function, Calling a function, Types of functions, Function arguments, Local and global variables, Lambda and recursive functions, Modules---Math, Random, OS, Date and Time	10
V	PANDAS What is Pandas?, Series, Data Frame, Read CSV Files, Analyzing Data Frames, Data Correlations, Data Cleaning---Empty cells, Data in wrong format, Wrong data, Duplicates, Pandas Plotting-- plot () method, bar plot, hist plot, box plot, area plot, scatter plot, pie plot	12

Prescribed Books:

1. Steven cooper--- Data Science from Scratch, Kindle edition
2. Reemathareja—Python Programming using problem solving approach, Oxford Publication

Reference Books:

- 1.Wes McKinney--- Python for Data Analysis ,O'REILLY

AG & SG SIDDHARTHA COLLEGE OF ARTS AND SCIENCES - VUYYURU.
An Autonomous college within the jurisdiction of Krishna University A.P, India.
(With Effect from Academic Year 2022-23)

COMPUTER SCIENCE	SECCAT02	2022-23	B.COM (CA)
-------------------------	-----------------	----------------	-------------------

SEMESTER – V/VI

PAPER – VII

Max. Marks 70

Model Paper: Data Analysis using Python

NO of Hours: 3

No Of Credits: 3

Pass Marks 28

Section – A

Answer any Four questions.

(At least 1 question should be given from each Unit)

(4 x 5=20Marks)

1. Write advantages of data science. (CO1, L1)
2. What are the qualifications of data scientist? (CO1, L2)
3. Explain about the history of python.(CO2, L1)
4. Explain about string operations in python.(CO3, L1)
5. Explain about the date and time module in python.(CO4, L1)
6. What is data cleaning? Explain about duplicates in pandas.(CO5, L1)

Section – B

Answer all questions.

(Two questions should be given from each unit with internal choice)

(5x10=50Marks)

9. (a) What is Data Science? Explain the Responsibilities of a data scientist.(CO1, L2)

OR

9. (b) Explain the use of python for data science?(CO1, L1)

10. (a) Explain different types of conditional statements with examples.(CO2, L1)

OR

10. (b) Explain different types of Looping statements with examples.(CO2, L1)

11. (a) What is a list? Explain different operations of lists with examples in python. (CO3, L2)

OR

11. (b)What is a Dictionary? Explain accessing values in it with examples in python (CO3, L2)

12. (a) Explain Function definition, calling & different types in python with example.(CO4, L1)

OR

12. (b) Explain about random and math module in python with an example.(CO4, L1)

13. (a) What is a data frame? Illustrate the concept of analysing the data frames.(CO5, L2)

AG & SG SIDDHARTHA COLLEGE OF ARTS AND SCIENCES - VUYYURU.
An Autonomous college within the jurisdiction of Krishna University A.P, India.
(With Effect from Academic Year 2022-23)

COMPUTER SCIENCE	SECCAT02	2022-23	B.COM (CA)
SEMESTER – V/VI	PAPER – VII	Max. Marks 50	

Lab List: DATASCIENCE USING PYTHON LAB

No. of Hours per week: 3 External: 40 Internal: 10 Credits: 2

I. Course Outcomes: Students at the successful completion of the course will be able to:

CO1: Implement simple programs in basics of python.(PO5)

CO2: Implement control structures in python.(PO5)

CO3: Implement data structures like strings, list, tuples, dictionaries in python.(PO5,PO7)

CO4:Implementation of data frames, data cleaning and plotting in pandas.(PO5,PO7)

II: Practical (Laboratory) Syllabus: (30 Periods)

1. Python Program to Find the Square Root
2. Python Program to Swap Two Variables
3. Python Program to Generate a Random Number
4. Python Program to check if a Number is odd or Even
5. Python Program to Find the Largest Among Four Numbers
6. Python Program to Check Prime Number
7. Python Program to Display the multiplication Table
8. Python Program to Print the Fibonacci sequence
9. Python Program to Check Armstrong Number
10. Python Program to Find the Sum of Natural Numbers
11. Python Program to Make a Simple Calculator
12. Python Program to Find Factorial of Number Using Recursion
13. Python Program to Add Two Matrices
14. Python Program to Multiply Two Matrices
15. Python Program to Check Whether a String is Palindrome or Not
16. Python Program to perform operations on strings.
17. Python Program to create a list and perform operations on its contents.
18. Python Program to perform operations on tuples.
19. Python Program to create a dictionary and print its content.
20. Python program to import data from CSV file using pandas.
21. Python program to demonstrate plots

III. Lab References:

1. Reemathareja—Python Programming using problem solving approach,Oxford Publication

Reference Materials on the Web/web-links:

1. <https://www.w3schools.com/python/>
2. <https://www.geeksforgeeks.org/python-basics/>

A.G & S.G.SIDDHARTHA DEGREE COLLEGE OF ARTS & SCIENCE
Vuyyuru-521165.NAAC recredited at 'A' level Autonomous -ISO 9001 – 2015 Certified

Title of the Paper: MOBILE APPLICATION DEVELOPMENT

Semester: V/VI

Course Code	<u>SECCAT03</u>	Course Delivery Method	Class Room / Blended Mode - Both
Credits	3	CIA Marks	30
No. of Lecture Hours / Week	3	Semester End Exam Marks	70
Total Number of Lecture Hours	60	Total Marks	100
Year of Introduction :2022-23	Year of Offering: 2022 - 23	Year of Revision: ----	Percentage of Revision: 0%

Course Objective: Covers introductory mobile application development for the Android Operating System using XML and Java. Includes developing simple applications that could run on Android phones and tablets. Covers Android application development phases, terminologies, application design, and coding.

Course Outcomes: Students at the successful completion of the course will be able to:

CO ₁	Identify basic terms, tools and software related to android systems.(PO5)
CO ₂	Describe components of IDE, understand features of android development tools.(PO5)
CO ₃	Describe the layouts and controls and different views available.(PO5,PO7)
CO ₄	Understand Android system architecture and security model.(PO5)
CO ₅	Understand the features of services and able to publish android Application.(PO5,PO7)

Syllabus

Course Details

Unit	Learning Units	Lecture Hours
I	Introduction to android, Open headset Alliance, Android ecosystem, Need of android, Features of android, Tools and Software required For developing an Application, Android architecture.	10
II	Operating system, java JDK, Android SDK, Android development tools, Android virtual devices, Steps to install and configure Android studio and sdk.	14
III	Control flow, directory structure, Components of a screen, Fundamental UI design, Linear layout, absolute layout, table layout, relative layout, Text view, Edit text, Button image button, radio button, toggle button, Radio group, checkbox, and progress bar ,List view, grid view, image view, scroll view, Time and date picker	12
IV	Android platform services, Android system Architecture, Android Security model, Applications development: creating small application.	12
V	Introduction of MIT App Inventor, Application Coding, Programming Basics & Dialog, More Programming Basics, Alarm Clock Application, Audio & Video, Drawing Application, File, Game, Device Location, Web Browsing.	12

References/ Text Book/ e-books/websites

Text Books:

1. Erik Hellman, "Android Programming – Pushing the Limits", 1st Edition, Wiley India Pvt Ltd, 2014.
2. App Inventor: create our own Android apps by Wolber, David (David Wayne)

Reference Books:

1. Dawn Griffiths and David Griffiths, "Head First Android Development", 1st Edition, O'Reilly SPDPublishers, 2015.
2. JFDiMarzio, "Beginning Android Programming with Android Studio", 4th Edition, Wiley India Pvt Ltd, 2016. ISBN-13: 978-8126565580

Web resources:

- <https://www.udacity.com/course/developing-android-apps-fundamentals--ud853-nd>
<http://www.appinventor.mit.edu/>

AG & SG SIDDHARTHA COLLEGE OF ARTS AND SCIENCES - VUYYURU.

An Autonomous college within the jurisdiction of Krishna University A.P, India.

(With Effect from Academic Year 2022-23)

COMPUTER SCIENCE	SECCAT03	2022-23	B. Com (CA)
------------------	----------	---------	-------------

SEMESTER – V/VI

PAPER – VI

Max. Marks 70

Syllabus: **Mobile Application Development**

NO. Of. Hours: 3

NO. Of Credits: 3

Pass Marks 28

Section- A

Answer any Four questions.

(At least 1 question should be given from each Unit)

(4 x 5 = 20Marks)

1. What is the Need of Android?(CO1,L1)
2. Explain the Steps to install and configure Android studio and sdk.(CO2,L2)
3. What are the Components of a screen?(CO3,L1)
4. What are the Android platform services?(CO4,L1)
5. How to write Application Coding?(CO5,L1)
6. Explain image button and radio button with an example.(CO3,L2)

Section- B

Answer all questions. (Two questions should be given from each unit with internal choice)

(5X10=50Marks)

9. (a) Explain Android Architecture.(CO1,L2)

OR

- (b) Write Features of Android.(CO1,L1)

10. (a) Explain Android development tools.(CO2,L2)

OR

- (b) Explain Android virtual devices.(CO2,L2)

- 11.(a)Explain about Linear layout, absolute layout, table layout and relative layout.(CO3,L2)

OR

- (b) Discuss about List view, grid view, image view, scroll view.(CO3,L6)

12. (a) How to create a small application using Android Application?(CO4,L6)

OR

- (b) Describe Android system Architecture.(CO5,L6)

13. (a)Explain Audio &Video Concepts.(CO5,L2)

OR

- (b) Develop Alarm clock application.(CO5,L6)

AG & SG SIDDHARTHA COLLEGE OF ARTS AND SCIENCES - VUYYURU.

An Autonomous college within the jurisdiction of Krishna University A.P, India.

(With Effect from Academic Year 2022-23)

COMPUTER SCIENCE	SECCAT03	2022-23	B. Com (CA)
-------------------------	-----------------	----------------	--------------------

SEMESTER – V/VI

PAPER – VI

Pass Marks 25

Max Marks:50

Lab List: MOBILE APPLICATION DEVELOPMENT LAB

No. of Hours per week: 2

External: 25

Internal: 25

Credits: 2

Course Outcomes: Students at the successful completion of the course will be able to:

CO1: Understand the android platform.(PO5,PO7)

CO2: Design and implementation of various mobile applications.(PO5,PO7)

Practical (Laboratory) Syllabus:

(30 Periods)

Lab Exercises

1. Demonstrate mobile technologies and devices.
2. Demonstrate Android platform and applications overview.
3. Implement User interface design layouts.
4. Working with texts, shapes, buttons and lists.
5. Develop a calculator application.
6. Develop application in android using different views.
7. Implement an application that creates a alarm clock.
8. Develop audio and video drawing application.

Lab References:

1. Erik Hellman, “Android Programming–Pushing theLimits”, 1stEdition, WileyIndiaPvt Ltd,2014.
2. App Inventor:create your own Android apps by Wolber, David (DavidWayne).

Reference Materials on the Web/web

1. <https://www.udacity.com/course/developing-android-appsfundamentals--ud853-nd>
2. <http://www.appinventor.mit.edu/>

A.G & S.G.SIDDHARTHA DEGREE COLLEGE OF ARTS & SCIENCE

Vuyyuru-521165.NAAC recredited at 'A' level
Autonomous -ISO 9001 – 2015 Certified

Title of the Paper: **CYBER SECURITY AND MALWARE ANALYSIS**

Semester: V/VI

Course Code	SECCAT04	Course Delivery Method	Class Room / Blended Mode - Both
Credits	3	CIA Marks	30
No. of Lecture Hours / Week	3	Semester End Exam Marks	70
Total Number of Lecture Hours	60	Total Marks	100
Year of Introduction :2022-23	Year of Offering: 2022-23	Year of Revision: ----	Percentage of Revision: 0%

Course Objective: This programme aims to provide a foundational platform for Cyber Security Aspirants by providing Cyber Security Awareness and Training that heighten the chances of catching a scam or attack before it is fully enacted, minimizing damage to the resources and ensuring the protection of information technology assets.

Course Outcomes: Students at the successful completion of the course will be able to:

CO ₁	Understand the computer networks, networking tools and cyber security.(PO6,PO7)
CO ₂	Learn about NIST Cyber Security Framework.(PO6,P07)
CO ₃	Understand the OWASP Vulnerabilities.(PO6, PO7)
CO ₄	Implement various Malware analysis tools.(PO6,P07)
CO ₅	Understand about Information Technology act2000.(PO6,P07)

Syllabus

Course Details

Unit	Learning Units	Lecture Hours
I	Introduction to Networks & cyber security: Computer Network Basics, Computer network types, OSI Reference model, TCP/IP Protocol suite, Difference between OSI and TCP/IP, What is cyber, cyber-crime and cyber-security, All Layer wise attacks, Networking devices: router, bridge, switch, server, firewall, How to configure :router, How to create LAN, Network tools, IP scanner, Port scanner, Vulnerability scanner, Command tools— net stack ,trace route, lookup, tcp view.	13
II	NISTN Cyber security framework: Introduction to the components of the framework, Cyber security Framework Tiers, What is NIST Cyber security framework, Features of NIST Cyber security framework, Functions of NIST Cyber security framework, Turn the NIST Cyber security Frame work into Reality/implementing the framework.	12
III	OWASP : What is OWASP? OWASP Top10Vulnerabilities, Injection, Broken Authentication, Sensitive Data Exposure, XML External Entities (XXE), Broken Access Control, Security Misconfiguration, Cross-Site Scripting(XSS), Insecure Deserialization, Using Components with Known Vulnerabilities, Insufficient Logging and Monitoring, OWASP Juice Shop, Web application firewall.	13
IV	MALWARE ANALYSIS : What is malware, Types of malware, Key loggers, Trojans, Ransom ware, Root kits, Antivirus, Firewalls, Malware analysis, VMware, How to uses and box, How to create virtual machine, Process explorer, Process monitor, SYS-internals Suite, SOC-security operations controls-Solar winds (study the tools), Network intrusion detection, Wire shark, IDS, IPS, Snort.	12
V	CYBER SECURITY Legal Perspectives : Cyber crime and the legal landscape around the world, IndianITACT2000— CybercrimeandPunishments, Weak areas of ITACT2000, Challenges to Indian law and cybercrime scenario in India, Amendments of the Indian IT Act.	10

References/ Text Book/ e-books/websites

TEXTBOOKS:

1. Computer Networks | Fifth Edition | By Pearson (6th Edition) |Tanenbaum, Feamster ,[Wetherall](#)
2. Computer Networking | A Top-Down Approach | Sixth Edition | By Pearson | [KuroseJamesF. Ross Keith W.](#)
3. Cyber Securityby[SunitBelapure,NinaGodbole](#)|WileyPublications
4. TCP/IP ProtocolSuite |Mcgraw-hill|Forouzan|FourthEdition

WEBSITEREFERENCES:

1. <https://csrc.nist.gov/Projects/cybersecurity-framework/nist-cybersecurity-framework-a-quick-start->
2. <https://owasp.org/www-project-top-ten/>
3. <https://owasp.org/www-project-juice-shop/>

AG & SG SIDDHARTHA COLLEGE OF ARTS AND SCIENCES - VUYYURU.
An Autonomous college within the jurisdiction of Krishna University A.P, India.
(With Effect from Academic Year 2022-23)

COMPUTER SCIENCE	SECCAT04	2022-23	B.Sc.(MPCs)
SEMESTER – V/VI	PAPER – VII	Max. Marks 70	

Title: CYBER SECURITY AND MALWARE ANALYSIS

No of Credits: 3

No.of.Hours:3

Pass Marks 28

Section-A

Answer any Four questions.

(At least 1 question should be given from each Unit)

(4X5=20Marks)

1. Discuss all Layer wise attacks.(CO1,L6)
2. Explain about Cyber, Cyber-Crime and Cyber-Attacks.(CO1,L2)
3. Explain Features of NIST Cyber Security framework.(CO2,L2)
4. Write about Web Application firewalls in OWASP.(CO3,L1)
5. Discuss about Key loggers, Trojans, Root kits.(CO4,L6)
6. Explain Weak areas of IT ACT 2000.(CO5,L2)

Section-B

Answer all questions. (Two questions should be given from each unit with internal choice)

(5x10=50Marks)

9(a). Describe in detail TCP/IP Protocol Suite with diagrammatic representation.(CO1,L6)

OR

9(b). Explain different types of Network Tools with examples.(CO1,L2)

10(a). Discuss about components of framework and functions of NIST Cyber Security frameworks.(CO2,L6)

OR

10(b). Explain how to turn NIST Cyber Security framework into reality framework. (CO2,L6)

11(a). Explain OWASD Juice shop in detail. (CO3,L2)

OR

11(b). Explain any 6 OWASP vulnerabilities.(CO3,L2)

12(a). Discuss about different types of Malware analysis in detail. (CO4,L6)

OR

12(b). How to detect Network intrusion? Explain?(CO4,L1)

13(a). Explain what are the Challenges are to Indian law and cybercrime scenario in India. (CO5,L2)

OR

13(b). Discuss Indian IT-ACT 2000.Explain different Cybercrime and Punishments respectively.(CO5,L6)

AG & SG SIDDHARTHA COLLEGE OF ARTS AND SCIENCES - VUYYURU.

An Autonomous college within the jurisdiction of Krishna University A.P, India.

(With Effect from Academic Year 2022-23)

COMPUTER SCIENCE	SECCAT04	2022-23	B. COM(CA)
------------------	----------	---------	------------

SEMESTER – V/VI

PAPER – VII

Max. Marks 50

Lab List: MULTIMEDIA TOOLS AND APPLICATIONS LAB

No. of Hours per week: 3

External: 40

Internal: 10

Credits: 2

Title :CYBER SECURITY AND MALWARE ANALYSYS LAB

I. Course Outcomes: Students at the successful completion of the course will be able to:

CO1: Implement LAN by using a switch and Router.(PO5)

CO2: Implement the task of creating mail messages by using fake mail id by using the "Fake mailer" website.(PO5)

CO3: Implement port scanning mechanism.(PO5)

CO4: Implement SQL Injection attack.(PO5)

CO5: Implement to access a locked computer.(PO5)

II: Practical (Laboratory) Syllabus:

(30 Periods).

Lab Exercises

The purpose of this course is to impart practical understanding on Cyber security and protection of electronic systems and information from malware attacks.

1. Configure LAN by using a switch
2. Configure a LAN by using Router
3. Steps to attack a victim computer by using "Pro Rat" Trojan tool
4. Perform the packet sniffing mechanism by download the "wire shark" tool and extract the packets
5. Perform the task of creating mail messages by using fake email id by using the "fake mailer" website(<https://emkei.cz>)
6. Perform the IP scanning mechanism by using "tracert" and "arp" commands
7. Perform the port scanning mechanism by using NMAP tool
8. Perform an SQL Injection attack and its preventive measure to avoid Injection attack
9. Perform an activity to access a locked computer without knowing the user's password.

III. Lab References:

1. Computer Networks | Fifth Edition | By Pearson (6th Edition) | [Tanenbaum, Feamster &Wetherall](#)
2. Computer Networking | A Top-Down Approach | Sixth Edition | By Pearson | [KuroseJamesF. Ross Keith W.](#)

IV. Reference Materials on the Web/web

1. <https://csrc.nist.gov/Projects/cybersecurity-framework/nist-cybersecurity-framework-a-quick-start-guide>

<https://owasp.org/www-project-top-ten/>

A.G & S.G.SIDDHARTHA DEGREE COLLEGE OF ARTS & SCIENCE

Vuyyuru-521165.NAAC reaccredited at 'A' level

Autonomous -ISO 9001 – 2015 Certified

Title of the Paper: E – **COMMERCE APPLICATION DEVELOPMENT**

Semester: V/VI

Course Code	SECCAT05	Course Delivery Method	Class Room / Blended Mode – Both
Credits	3	CIA Marks	30
No. of Lecture Hours / Week	3	Semester End Exam Marks	70
Total Number of Lecture Hours	60	Total Marks	100
Year of Introduction :2022-23	Year of Offering: 2022-23	Year of Revision: -----	Percentage of Revision: 0%

Course Objective:

To educate students in ecommerce and ecommerce applications.

Course Outcomes: Upon successful completion of the course, a student will be able to:

CO ₁	To apply in an integrative and summative fashion the students' knowledge in all fields of business studies by drafting a website presence plan.
CO ₂	To understand the factors needed in order to be a successful in ecommerce
CO ₃	To gain the skills to bring together knowledge gathered about the different components of building a web presence
CO ₄	To critically think about problems and issues that might pop up during the establishment of the web presence
CO ₅	To apply Word Press as a content management system (CMS), Plan their website by choosing color schemes, fonts, layouts, and more

Syllabus

Course Details

Unit	Learning Units	Lecture Hours
I	Introduction to E- commerce: Meaning and concept – E- commerce , E-commerce v/s Traditional Commerce , E- Business & E- Commerce – History of E- Commerce , EDI – Importance, features & benefits of E- Commerce , Impacts, Challenges & Limitations of E- Commerce	12
II	Business models of E – Commerce: Business to Business , Business to customers ,Customers to Customers , Business to Government , Business to Employee , Influencing factors of successful E- Commerce , Architectural framework of Electronic Commerce , Web based E Commerce Architecture. Internet Commerce	12
III	Electronic data Interchange , EDI Technology ,EDI- Communications , EDI Agreements , E- Commerce payment system. Digital Economy	12
IV	A Page on the web - HTML Basics , Client Side scripting -JAVA SCRIPT basics , Server side Scripting- PHP basics	12
V	Logging in to Your Word press Site , word press dash board , creating your first post , adding photos and images , creating hyper link , adding categories and tags	12

Textbooks:

1. Turban, Rainer, and Potter, Introduction to E-Commerce, second edition, 2003
2. H. M. Deitel, P. J. Deitel and T. R. Nieto, E-Business and E-Commerce: How to Programe, Prentice hall, 2001
3. Word Press All-in-One For Dummies -written by Lisa Sabin Wilson with contributions by Michael Torbert, Andrea Rennick, Cory Miller, and Kevin Palmer

Reference Books:

1. Elias. M. Awad, "Electronic Commerce", Prentice-Hall of India Pvt Ltd.
2. Ravi Kalakota, Andrew B. Whinston, "Electronic Commerce-A Manager's guide", Addison-Wesley
3. <https://w3schools.com>
4. David Whitely, E-Commerce: Strategy, Technologies and Applications, Tata McGraw Hill.

AG & SG SIDDHARTHA COLLEGE OF ARTS AND SCIENCES - VUYYURU.

An Autonomous college within the jurisdiction of Krishna University A.P, India.

(With Effect from Academic Year 2022-23)

COMPUTER SCIENCE	SECCAT05	2022-23	B.COM (CA)
------------------	-----------------	---------	------------

SEMESTER – V/VI

PAPER – VI

Max. Marks 50

Lab List: E – **COMMERCE APPLICATION DEVELOPMENT Lab**

No. of Hours per week:3

External: 40

Internal: 10

Credits: 2

I. Course objectives:

To educate students in developing commerce applications.

Course outcomes:

By the end of the course, students will be:

CO1: Able to design home page for an e commerce web application. (PO6, PO7)

CO2: Able to perform validation using PHP. (PO6, PO7)

CO3: Able to design catalogue. (PO6, PO7)

CO4: Able to implement access control mechanisms in web applications. (PO6, PO7)

CO5: Able to design application for any given e-commerce scenario. (PO6, PO7)

II: Practical (Laboratory) Syllabus: (30 Periods)

(Since, the proposed SECs are connected to Computer Programming/Software Tools and Skill enhancement, the students need to get exposure on the syllabus content by practicing on the computer even though there is no formal assignment of credits and laboratory hours for practical sessions. So, as part of the Co-curricular activities and continuous assessment, students should be engaged in practicing on computer for at least 30 hours per semester.)

Case study of e –commerce

1. Home page design of web site
2. Validation using PHP
3. Implement Catalogue design
4. Implement Access control mechanism(eg: username and password)
5. Case study on business model of online E-Commerce store

Note: The list of experiments need not be restricted to the above list. Detailed list of Programming/software tool based exercises can be prepared by the concerned faculty members.

A.G & S.G.SIDDHARTHA DEGREE COLLEGE OF ARTS & SCIENCE

Vuyyuru-521165.NAAC recredited at 'A' level

Autonomous -ISO 9001 – 2015 Certified

Title of the Paper: REAL TIME GOVERNANCE SYSTEM (RTGS)

Semester: V/VI

Course Code	SECCAT06	Course Delivery Method	Class Room / Blended Mode - Both
Credits	3	CIA Marks	30
No. of Lecture Hours / Week	3	Semester End Exam Marks	70
Total Number of Lecture Hours	60	Total Marks	100
Year of Introduction :2022-23	Year of Offering: 2022 - 23	Year of Revision: ----	Percentage of Revision: 0% (shuffled from 4 th to 3 rd sem)

Course Objective:

To educate students in terms of e governance, its infrastructure and implementation.

Course Outcomes: Upon successful completion of this course, students will have the knowledge and skills to:

CO ₁	Understand the terms regarding Governance, E-Governance and RTGS (PO6, PO7)
CO ₂	Learn about E-Governance Infrastructure (PO6, PO7)
CO ₃	Understand the E-Governance implementation in several countries (PO6, PO7)
CO ₄	Understand the E-Governance implementation in several Indian states (PO6, PO7)
CO ₅	Understand the applications of RTG (PO6, PO7)

Syllabus

Course Details

Unit	Learning Units	Lecture Hours
I	Introduction to E-Governance Government, Governance and Good Governance, What is E-Governance or Electronic Governance? E-Government and E-Governance: A conceptual Analysis , Objectives , Components , application domains , four phase model , implementing E-Governance ,issues while implementing E-Governance , Opportunities and challenges . Types of E-Governance , What is Real-Time Governance (RTG) , Real Time Governance Society (RTGS)	12
II	E-Governance Infrastructure Data Systems infrastructure , Executive Information Systems , Management Information Systems ,Knowledge Management Systems , Transaction Processing Systems . Legal Infrastructural preparedness , IT Act 2000 , Challenges to Indian law and cybercrime scenario in India , Amendments of the Indian IT Act . Institutional Infrastructural preparedness , Internet , intranet , extranet • Human Infrastructural preparedness , Top-level management , Middle-level management, Low-level management • Technological Infrastructural preparedness ,Information and communications technology , Data Warehousing , Cloud Computing.	12
III	E-Governance: Country Experience INDIA ,US, UK ,AUSTRALIA , DUBAI	12
IV	E-Governance in India Andhra Pradesh , Karnataka , Kerala , Uttar Pradesh , Madhya Pradesh , West Bengal ,Gujarat UNIT 5: Latest Applications in Real Time Governance 10hrs Agriculture ,Rural Development ,Health care ,Education ,Tourism , Commerce and Trade	12
V	Latest Applications in Real Time Governance Agriculture ,Rural Development ,Health care ,Education ,Tourism , Commerce and Trade	12

III Textbooks:

1. E-Governance: concepts and case studies| CSR Prabhu| Prentice-Hall|
2. E-Governance| Niranjani, Sanhari Mishra | Himalaya Publishing House

Website References:

1. <http://www.egov4dev.org/success/case/>
2. <https://vikaspedia.in/e-governance/resources-for-vles>
3. <https://altametrics.com/en/information-systems/information-system-types.html>
4. <https://core.ap.gov.in/CMDashBoard/Index.aspx>

AG & SG SIDDHARTHA COLLEGE OF ARTS AND SCIENCES - VUYYURU.
An Autonomous college within the jurisdiction of Krishna University A.P, India.
(With Effect from Academic Year 2022-23)

COMPUTER SCIENCE	SECCAT06	2022-23	B.Com.(C.A.)
SEMESTER – V/VI	PAPER – VII	Max. Marks 50	

LAB LIST: REAL TIME GOVERNANCE SYSTEM (RTGS) Lab

No. of Hours per week: 2 External: 40 Internal: 10 Credits: 2

I. Course objectives:

To educate students in developing e commerce applications.

Course outcomes:

By the end of the course, students will be:

CO1: Able to design home page for an e commerce web application. (PO6, PO7)

CO2: Able to perform validation using PHP. (PO6, PO7)

CO3: Able to design catalogue. (PO6, PO7)

CO4: Able to implement access control mechanisms in web applications. (PO6, PO7)

CO5: Able to design application for any given e-commerce scenario. (PO6, PO7)

II: Practical (Laboratory) Syllabus: (30 Periods)

(Since, the proposed SECs are connected to Computer Programming/Software Tools and Skill enhancement, the students need to get exposure on the syllabus content by practicing on the computer even though there is no formal assignment of credits and laboratory hours for practical sessions. So, as part of the Co-curricular activities and continuous assessment, students should be engaged in practicing on computer for at least 15 hours per semester.)

Note: Here the students have to gather the details in computer lab by surfing several websites & Google Search Engines and submit the report to the class/lab instructor before leaving the lab.

1. Write a Report on the role of Nationwide Networking in E-Governance
2. Write a Report on SETU: A Citizen Facilitation Centre in India, regarding it's successful or failure journey.
3. Write a Report on National Cyber Security Policy, how it is useful to Indian citizens.
4. Write a Report on mee-seva/Village Secretariat/Ward secretariat, a new paradigm in citizen services.
5. Write a Report on how Andhra Pradesh is implementing RTGS in Agriculture.
6. Write a Report on how Andhra Pradesh is implementing RTGS in social welfare schemes
7. Write a Report on how Andhra Pradesh is implementing RTGS in waste lands, agricultural lands and house properties.
8. Write a Report on Electronic Birth Registration in any one state of our country.

Note: The list of experiments need not be restricted to the above list. Detailed list of Programming/software tool based exercises can be prepared by the concerned faculty members.

A.G & S.G.SIDDHARTHA DEGREE COLLEGE OF ARTS & SCIENCE

Vuyyuru-521165.NAAC reaccruited at 'A' level

Autonomous -ISO 9001 – 2015 Certified

Title of the Paper: **MULTIMEDIA TOOLS AND APPLICATIONS**

Semester: V/VI

Course Code	SECCAT07	Course Delivery Method	Class Room / Blended Mode - Both
Credits	3	CIA Marks	30
No. of Lecture Hours / Week	3	Semester End Exam Marks	70
Total Number of Lecture Hours	60	Total Marks	100
Year of Introduction :2022-23	Year of Offering: 2022 -23	Year of Revision: ----	Percentage of Revision: 0%

Course Objective: Multimedia is a technology engaging variety of media .Multimedia is the collection of Text, audio, video, animation, and graphics. The concept of paperless society is effective with the invention of multimedia. Multimedia helps the user in providing information from different media on one platform. It's enhanced the concept of networking and resource sharing.

Course Outcomes: Students at the successful completion of the course will be able to:

CO ₁	Gain knowledge on the concepts related to Multimedia.(PO5)
CO ₂	Understand the concepts like image data representation and color modes.(PO5)
CO ₃	Understand the different types of video signals and digital audio.(PO5)
CO ₄	Know about multimedia data compression types and audio compression standards (PO5)
CO ₅	Know about basic video compression techniques.(PO5,P07)

Syllabus

Course Details

Unit	Learning Units	Lecture Hours
I	Introduction to multimedia What is Multimedia? , Components of Multimedia System, Multimedia Research Topics and Projects, Multimedia and Hypermedia, Multimedia Authoring metaphors, Multimedia Production, Multimedia Presentation, Some Technical Design Issues, Automatic Authoring.	12
II	Image Data Representations and color models Color science Human vision Image data types, Black & white images -1-bit images (Binary image), 8 -bit (Gray -level images), Color images - 24-bit color images, 8-bit color images, Color models. Color science Human vision Image data types, Black & white images -1-bit images (Binary image), 8 -bit (Gray -level images), Color images - 24-bit color images, 8-bit color images, Color mo	12
III	Fundamental concepts in video Types of Video Signals- Analog Video, Digital Video, Basics of Digital Audio: What is Sound?, Digitization of Sound, Quantization and Transmission of Audio, Pulse code modulation, Differential coding of audio, Predictive coding, DPCM.	14
IV	Multimedia Data Compression Introduction- Basics of Information Theory, Lossless Compression Algorithms, Fix-Length Coding, Run-length coding, Differential coding, Dictionary-based coding, Variable Length Coding, Shannon-Fano Algorithm, Huffman Coding Algorithm. Audio Compression standards: Introduction, Psychoacoustics model, MPEG Audio	12
V	Basic Video Compression Techniques Introduction to Video compression, Video Compression with Motion Compensation, Video compression standard H.261, Video compression standard MPEG-1	10

1. Text Books

Fundamentals of Multimedia by Ze-Nian Li & Mark S. Drew. Publisher: Prentice Hall

2. Reference Books:

1. An introduction to digital multimedia by Savage, T. M. and Vogel, K. E. 2008.
2. Digital Multimedia by Nigel Chapman & Jenny Chapman. 2009.

3. Reference Materials on the Web/web-links:

<https://www.tutorialspoint.com/multimedia>

<https://ksuit342.wordpress.com/lectuers/>

AG & SG SIDDHARTHA COLLEGE OF ARTS AND SCIENCES - VUYYURU.
An Autonomous college within the jurisdiction of Krishna University A.P, India.
(With Effect from Academic Year 2022-23)

COMPUTER SCIENCE	SECCAT07	2022-23	B.Com.(C.A.)
SEMESTER – V/VI	PAPER – VI	Max. Marks 70	

Model Paper: Multimedia Tools and Applications

NO of Hours: 3

No Of Credits: 3

Pass Marks 28

Section-A

Answer any FIVE questions.

(At least 1 question should be given from each Unit)

(4 x 5=20Marks)

- 1. What is multimedia? Explain components of multimedia system. (CO1, L1)**
- 2. Discuss multimedia production. (CO1, L6)**
- 3. Explain 8-Bit(gray-level images). (CO2, L2)**
- 4. What is sound? Explain digitization of sound. (CO3, L1)**
- 5. Discuss Run-length coding. (CO4, L6)**
- 6. Compare and contrast H.261 and MPEG-1. (CO5, L2)**

Section-B

Answer all questions. (Two questions should be given from each unit with internal choice)

(5 x 10 = 50M)

- 9.(a) Discuss in detail about multimedia and hypermedia. (CO1, L6)**

OR

- (b) Explain about multimedia presentation. (CO1, L2)**

- 10.(a) Discuss about 24-bit color images and 8-bit color images. (CO2, L6)**

OR

- (b) Explain Color models in images. (CO2, L2)**

- 11.(a) Discuss about PCM(pulse code modulation). (CO3, L6)**

OR

- (b) Explain High-Definition TV(HDTV). (CO3, L2)**

- 12.(a) Discuss Huffman- coding algorithm. (CO4, L6)**

OR

- (b) Write about MPEG audio compression algorithm. (CO4, L1)**

- 13.(a) Explain video compression based on motion compensation. (CO5, L2)**

OR

- (b) Write about Video compression standard H.261. (CO5, L1)**

AG & SG SIDDHARTHA COLLEGE OF ARTS AND SCIENCES - VUYYURU.

An Autonomous college within the jurisdiction of Krishna University A.P, India.

(With Effect from Academic Year 2022-23)

COMPUTER SCIENCE	SECCAT07	2022-23	B.COM(CA)
-------------------------	-----------------	----------------	------------------

SEMESTER – V/VI

PAPER – VI

Max. Marks 50

Lab List: MULTIMEDIA TOOLS AND APPLICATIONS LAB

No. of Hours per week: 3 External: 40

Internal: 10

Credits: 2 Pass Marks:30

I. Course Outcomes:

Students at the successful completion of the course will be able to:

CO1: Create/modify a new image with open source applications such as GIMP. (PO5)

CO2: Manipulate images using graphic tools. (PO5)

CO3: Learn basic layer mask essentials. (PO5)

CO4: Compress audio and video files. (PO5, PO7)

CO5: Create a realistic shadow. (PO5)

II: Practical (Laboratory) Syllabus: (30 Periods)

1. Editing images using GIMP
2. Improve the Quality of your Image in GIMP
3. Introduction to Layer Masks.
4. Create an impressive background in GIMP
5. Applying Shadow & Highlight effects in images
6. Black& white and color photo conversion.
8. Using File Seizer Software for Audio compression.
9. Using File seizer Software for Video compression.

III. Lab References:

Fundamentals of Multimedia by Ze-Nian Li & Mark S. Drew. Publisher: Prentice Hall

Reference Materials on the Web/web-links

<https://ksuit342.wordpress.com/lecturers/>

<https://www.tutorialspoint.com/multimedia>

A.G & S.G.SIDDHARTHA DEGREE COLLEGE OF ARTS & SCIENCE

Vuyyuru-521165.NAAC recredited at 'A' level

Autonomous -ISO 9001 – 2015 Certified

Title of the Paper: DIGITAL IMAGING

Semester: V/VI

Course Code	SECCAT08	Course Delivery Method	Class Room / Blended Mode - Both
Credits	3	CIA Marks	30
No. of Lecture Hours / Week	3	Semester End Exam Marks	70
Total Number of Lecture Hours	60	Total Marks	100
Year of Introduction :2022-23	Year of Offering: 2022 -23	Year of Revision: ----	Percentage of Revision: 0%

Course Objective: To introduce the concepts of image processing and basic analytical methods to be used in image processing. To familiarize students with image enhancement and restoration techniques, To explain different image compression techniques.

Course Outcomes: Students at the successful completion of the course will be able to:

CO ₁	Gain knowledge about Types of Graphics, Types of Objects, Types of video editing tools.(PO5)
CO ₂	Show their skills in editing and altering photographs for through a basic understanding of the tool box.(PO5)
CO ₃	Gain knowledge in using the layers.(PO5)
CO ₄	Gain knowledge in using the selection tools, repair tools.(PO5)
CO ₅	Gain knowledge in using selection tools, applying filters and can show their skills.(PO5)

Syllabus

Course Details

Unit	Learning Units	Lecture Hours
I	Types of Graphics- Raster vs Vector Graphics ,Types of Objects - Audio formats, Video formats , Image formats , Text document formats, Types of video editing , Different color modes, Image Scanner- Types of Image Scanners	12
II	What is GIMP? , GIMP tool box window, Layers Dialog , Tool Options Dialog , Image window , Image window menus	12
III	Improving Digital Photos - Opening files, Rescaling saving files, Cropping, Brightening & Darkening 1 Rotating, Sharpening, Fixing Red Eye. Introduction to layers- What is layer?, Using layer to add text , Using move tool , Changing colors , Simple effects on layers, Linking layers together , Performing operations on layers, Using layers to copy and paste, Tour of layers dialog	14
IV	Drawing- Drawing lines and curves , Changing colors and brushes, Erasing , Drawing rectangles, Circles and other shapes, Outlining and filling regions, Filling with patterns and gradients, Importing brushes or gradients or making your own. Selection: Working with selections, Select by color and fuzzy, Select Bezier paths, intelligent scissors tool, Modifying selections with selection modes.	12
V	Erasing and Touching Up: Dodge and burn tool, Smudging tool , Clone tool , Sharpening using convolve tool, Blurring with Gaussian Blur , Correcting Color Balance, Hue , Saturation , Color balance using curves and levels. Filters: Filters , Blur, Enhance , Distort, Noise Filters.	10

References/ Text Book/ e-books/websites

Textbook: Beginning GIMP from Novice to professional by Akkana Peck, Second Edition, A press

Reference Materials on the Web/web-links:

<https://www.mygreatlearning.com/gimp/tutorials/gimp-introduction>

AG & SG SIDDHARTHA COLLEGE OF ARTS AND SCIENCES - VUYURU.
An Autonomous college within the jurisdiction of Krishna University A.P, India.
(With Effect from Academic Year 2022-23)

COMPUTER SCIENCE	SECCAT08	2022-23	B.Com.(C.A.)
-------------------------	-----------------	----------------	---------------------

SEMESTER – V/VI

PAPER – VII

Max. Marks 70

Model Paper: Digital Imaging

NO of Hours: 3

No Of Credits: 3

Pass Marks 28

SECTION – A

Short Answer Questions

(5 x 5=25M)

Answer any Four questions. (At least 1 question should be given from each Unit)

- 1. Explain different types of image formats.(CO1,L2)**
- 2. Write short notes on Tool box in GIMP.(CO2, L1)**
- 3. Explain briefly about gradients in GIMP. (CO4, L2)**
- 4. Write short notes on clone tool in GIMP.(CO5,L1)**
- 5. Explain rotating ,sharpening in GIMP.(CO3,L2)**
- 6. Describe different color modes in GIMP.(CO1,L5)**

SECTION B

Answer all questions.

(5 x 10 = 50M)

9(a) Describe the various color modes in GIMP with example.(CO1,L5)

OR

9(b) What are various types of audio and video formats in GIMP? Explain with example.(CO1,L1)

10(a) Describe image window menu in detail.(CO2, L5)

OR

10(b) Explain the window layers dialog in GIMP.(CO2, L2)

11(a) Describe Cropping-Brightening and Darkening in GIMP.(CO3, L5)

OR

11(b) Explain the steps to solve a fixed-red eye in GIMP.(CO3,L2)

12(a) Explain the working with selections in GIMP.(CO4, L2)

OR

12(b) Write about filling with patterns and gradients.(CO4, L1)

13(a) Describe the steps involved in Dodge, Burn and Smudging tool in GIMP.(CO5,L5)

OR

13(b) Write about distort and noise filters in GIMP.(CO5,L1)

AG & SG SIDDHARTHA COLLEGE OF ARTS AND SCIENCES - VUYYURU.

An Autonomous college within the jurisdiction of Krishna University A.P, India.

(With Effect from Academic Year 2022-23)

COMPUTER SCIENCE	SECCAT08	2022-23	B. COM(CA)
SEMESTER – V/VI	PAPER – VII	Max. Marks 50	

Lab List: DIGITAL IMAGING LAB

No. of Hours per week: 3

External: 40

Internal: 10

Credits: 2

I. Course Outcomes: Students at the successful completion of the course will be able to:

CO1:Students will gain a working knowledge of Photoshop (PO5)

CO2:Student will be able to show their skills in editing and altering photographs for through a basic understanding of the tool bar. (PO5)

CO3:Student will gain knowledge in using the layers. (PO5)

CO4:Student will gain knowledge in using the selection tools, repair tools.(PO5,PO7)

CO5:Student will gain knowledge in using filters and can show their skills. (PO5)

II: Practical (Laboratory) Syllabus: (30 Periods)

1. Designing a Visiting card
2. Design Cover page of a book
3. Paper add for calling tenders
4. Passport photo design
5. Design a Pamphlet
6. Brochure designing
7. Titles designing
8. Custom shapes creation
9. Black & white and color photo conversion
10. Image size modification
11. Background changes
12. Texture and patterns designing
13. Filter effects & Eraser effects

A.G & S.G.SIDDHARTHA DEGREE COLLEGE OF ARTS & SCIENCE

Vuyyuru-521165.NAAC reaccredited at 'A' level

Autonomous -ISO 9001 – 2015 Certified

Title of the Paper: DATABASE MANAGEMENT SYSTEMS

Semester: III

Course Code	CSCT37	Course Delivery Method	Class Room / Blended Mode - Both
Credits	3	CIA Marks	25
No. of Lecture Hours / Week	4	Semester End Exam Marks	75
Total Number of Lecture Hours	60	Total Marks	100
Year of Introduction :2021	Year of Offering: 2021-22	Year of Revision: ----	Percentage of Revision: 0%

Course Objective: The main objective of the database is **to ensure that data can be stored and retrieved easily and effectively**. It is a compilation of data (records) in a structured way. In a database, the information is stored in a tabular form where data may or may not interlinked.

Course Outcomes:

CO ₁	Understand database concepts and design. (PO5,P07)
CO ₂	Create databases using structured query language. (PO5, P07)
CO ₃	Apply data manipulation commands in SQL. (PO5, P07)
CO ₄	Learn the programming basics of PL/SQL. (PO5, P07)
CO ₅	Implementation of cursors in PL/SQL. (PO5, P07)

Syllabus

Unit	Learning Units	Lecture Hours
I	Database Concepts-A Relational approach: Database - Relationships - DBMS - Relational data model - Integrity rules - Theoretical relational languages. Database Design: Data modeling -Dependency - Database design - Normal forms - Dependency diagrams – Denormalization.	12
II	Structured Query Language (SQL): Introduction – DDL - Naming rules and conventions - Data types-Constraints- Creating a table- Displaying table information - Altering an existing table – Dropping, renaming, and truncating table - Table types	12
III	Working with tables: DML - Adding a new Row/Record - Customized prompts - Updating and deleting an existing rows/records - Retrieving data from table - Arithmetic operations - Restricting data with WHERE clause - Sorting - Substitution variables - DEFINE command - CASE structure. Functions and Grouping: Built-in functions - Grouping data. Joins and Views: Join - join types- Views: Views - Creating a view - Removing a view - Altering a view.	12
IV	PL/SQL: Fundamentals - Block structure - comments - Data types – Other data types - Variable declaration - Assignment operation - Bind variables - Substitution variables - Printing. Control Structures and Embedded SQL: Control structures - Nested blocks - SQL in PL/SQL - Data manipulation - Transaction control statements	12
V	PL/SQL Cursors and Exceptions: Cursors - Implicit & explicit cursors and attributes - cursor FOR loops - SELECT...FOR UPDATE - WHERE CURRENT OF Clause - cursor with parameters - Cursor variables - Exceptions - Types of exceptions - Records - Tables -Procedures - <u>Functions</u> -Triggers	12

Course Delivery method: Face-to-face / Blended

Course has focus on: Skill Development.

Websites of Interest:

- <https://www.tutorialspoint.com/dbms/index.htm>
- <https://www.tutorialspoint.com/plsql/index.htm>

AG & SG SIDDHARTHA COLLEGE OF ARTS AND SCIENCES - VUYYURU.
An Autonomous college within the jurisdiction of Krishna University A.P, India.
(With Effect from Academic Year 2020-21)
DATABASE MANAGEMENT SYSTEMS

MODEL PAPER

CLASS: B.Sc. (MSCS, MCCS, MPCS)

Course Code: CSCP37

Semester: III

Max. Marks: 75M

Min. Pass: 30M

Time: 3 Hours

SECTION – A

ANSWER ANY FIVE QUESTIONS

(5 X 5 =25 M).

1. Define the following terms:
 1.Entity.2.Entity set.3.Attribute.4.Tuple.5Key. (CO1,L2)
2. What are the integrity rules of the relational model? (CO1,L2)
3. Describe the naming rules and conventions of SQL. (CO2,L2)
4. List out data types of SQL with a brief description. (CO2,L2)
5. Explain about WHERE clause. (CO3,L2)
6. How to add a record in to table. List various methods. (CO3,L3)
7. Explain the PL/SQL block structure. (CO4,L2)
8. What is the purpose of a Trigger? Give any example. (CO5,L2)

SECTION – B

ANSWER ALL THE QUESTIONS

5 X 10 =50 M.

9. a) Explain about Normal forms with examples. (CO1, L2)
 (Or)
 b) What are different types of keys? What is their use? (CO1, L2)
10. a) How to enforce different types of constraints on tables? (CO2,L2)
 (or)

b) Write a SQL query to create the following tables with the following fields and constraints and insert 5 records in each table in oracle.

Deptno	Number	Primary key
Dname	Varchar	
Loc	varchar	

Empno	Number	Primary key
Ename	Varchar	Should not null
Job	Varchar	
Hiredate	Date	Default system date
Mgr	Number	Foreign key to empno
Sal	Floating point number	Should not exceed one lakh
Comm	Floating point number	
Deptno	Number	Foreign key to deptno in dept table

Insert 5 records into each table (CO2,L3)

11. a) Give a brief description about joins and explain types of joins with examples. (CO3,L3)
 (or)
 b) What are the various types of functions available in Oracle? List and explain at least 4 from each category. (CO3,L3)
12. a) Explain about the control structures in PL/SQL. (CO4,L2)
 (or)
 b) How to manipulate (insert/update/delete) the data in PL/SQL? (CO4,L2)
13. a) Differentiate between implicit and explicit cursors with examples. (CO5, L3)
 (or)
 b) Explain about built in exceptions in Oracle. (CO5,L2)

AG & SG SIDDHARTHA COLLEGE OF ARTS AND SCIENCES - VUYYURU.

An Autonomous college within the jurisdiction of Krishna University A.P, India.

(With Effect from Academic Year 2020-21)

DATABASE MANAGEMENT SYSTEMS

COMPUTER SCIENCE	CSCP36	2022-23	B.Sc.(MPCS,MCCs, MSCS)
-------------------------	---------------	----------------	-------------------------------

Year of Introduction: 2021

Year of offering: 2021

Semester: III

Credits: 1

Hours Taught: 30 hrs. Per Semester

Max.Time: 3 Hours

Course Prerequisites (if any): Basic knowledge in computers and internet concepts.

Course Description: This course focuses towards Database System Concepts and Architecture, ER models, relational algebra relational calculus, SQL and PL/SQL.

Course Objectives:

1. Enhance the knowledge and understanding of Database concepts and design.
2. Enhance the knowledge of the processes of Database Development using SQL
3. Enhance the knowledge of the processes of Database manipulation using SQL
4. Develop efficient PL/SQL programs to access Oracle databases

Course Outcomes: At the end of this course, students should be able to:

CO1: Understand database concepts and design. (PO5, P07)

CO2: Create databases using structured query language. (PO5, P07)

CO3: Apply data manipulation commands in SQL. (PO5, P07)

CO4: Learn the programming basics of PL/SQL. (PO5, P07)

CO5: Implementation of cursors in PL/SQL. (PO5, P07)

LAB LIST

1. Using Different operators
2. Using Control Structures
3. Implement Built-in functions
4. Implement update and Alter table
5. Implementing PL/SQL Block
6. Implement PL/SQL table and record
7. Using Functions
8. Using Cursors
9. Using Triggers

@ @ @ @

AG & SG SIDDHARTHA COLLEGE OF ARTS AND SCIENCES - VUYURU.
An Autonomous college within the jurisdiction of Krishna University A.P, India.
 (With Effect from Academic Year 2021-22)

Title of the Paper: Problem solving in C

Semester: III

CLASS B.Com(E-Commerce- Computers)

Course Code	CSCT11B	Course Delivery Method	Class Room / Blended Mode - Both
Credits	3	CIA Marks	25
No. of Lecture Hours / Week	4	Semester End Exam Marks	75
Total Number of Lecture Hours	60	Total Marks	100
Year of Introduction :2020-21	Year of Offering: 2021 - 22	Year of Revision: ----	Percentage of Revision: 0%

Course Objective

This course aims to provide exposure to problem-solving through programming and introduce the concepts of the C Programming language.

Course Learning Outcomes:

Course Outcome No	Upon successful completion of the course, a student will be able to:	Program Outcome No.
CO1	Understand the evolution & functionality of Digital Computers and develop an algorithm for solving a given problem.	PO1, PO7, PSO1, PSO4
CO2	Understand tokens and control structures in C.	PO1, PO7, PSO1, PSO4
CO3	Understand arrays and strings and implement them.	PO1, PO7, PSO1, PSO4
CO4	Understand the right way of using functions, pointers, structures and unions in C	PO1, PO7, PSO1, PSO4
CO5	Develop and test programs written in C files	PO1, PO7, PSO1, PSO4

UNIT I

12 periods

General Fundamentals: Introduction to computers: Block diagram of a computer, characteristics and limitations of computers, applications of computers, types of computers, computer generations.

Introduction to Algorithms and Programming Languages: Algorithm – Key features of Algorithms, Flow Charts, Programming Languages – Generations of Programming Languages – Structured Programming Language- Design and Implementation of Correct, Efficient and Maintainable Programs.

UNIT II

12 periods

Introduction to C: Introduction – Structure of C Program – Writing the first C Program –File used in C Program – Compiling and Executing C Programs – Using Comments – Keywords – Identifiers – Basic Data Types in C – Variables – Constants – I/O Statements in C- Operators in C- Programming Examples.

Decision Control and Looping Statements: Introduction to Decision Control Statements– Conditional Branching Statements – Iterative Statements – Nested Loops – Break and Continue Statement – goto Statement.

UNIT III

10 periods

Arrays: Introduction – Declaration of Arrays – Accessing elements of the Array – Storing Values in Array– Operations on Arrays – one dimensional, two dimensional and multi-dimensional arrays, character handling and strings.

UNIT IV

14 periods

Functions: Introduction – using functions – Function declaration/ prototype – Function definition – function call – return statement – Passing parameters – Scope of variables – Storage Classes – Recursive functions.

Structure, Union, and Enumerated Data Types: Introduction – Nested Structures – Arrays of Structures – Structures and Functions– Union – Arrays of Unions Variables – Unions inside Structures – Enumerated Data Types.

UNIT V

12 periods

Pointers: Understanding Computer Memory – Introduction to Pointers – declaring Pointer Variables – Pointer Expressions and Pointer Arithmetic – Null Pointers - Passing Arguments to Functions using Pointer – Pointer and Arrays – Memory Allocation in C Programs – Memory Usage – Dynamic Memory Allocation – Drawbacks of Pointers

Files: Introduction to Files – Using Files in C – Reading Data from Files – Writing Data to Files – Detecting the End-of-file – Error Handling during File Operations – Accepting Command Line Arguments.

BOOKS

1. E Balagurusamy – Programming in ANSIC – Tata McGraw-Hill publications.
2. Brain W Kernighan and Dennis M Ritchie - The ‘C’ Programming language” - Pearson publications.
3. Ashok N Kamthane: Programming with ANSI and Turbo C, Pearson Edition Publications.
4. Yashavant Kanetkar - Let Us ‘C’ – BPB Publications.

RECOMMENDED CO-CURRICULAR ACTIVITIES:

(Co-curricular activities shall not promote copying from textbook or from others work and shall encourage self/independent and group learning)

A. Measurable

1. Assignments (in writing and doing forms on the aspects of syllabus content and outside the syllabus content. Shall be individual and challenging)
2. Student seminars (on topics of the syllabus and related aspects (individual activity))
3. Quiz (on topics where the content can be compiled by smaller aspects and data (Individuals or groups as teams))
4. Study projects (by very small groups of students on selected local real-time problems pertaining to syllabus or related areas. The individual participation and contribution of students shall be ensured (team activity)

B. General

1. Group Discussion
2. Try to solve MCQ’s available online.
3. Others

RECOMMENDED CONTINUOUS ASSESSMENT METHODS:

Some of the following suggested assessment methodologies could be adopted;

1. The oral and written examinations (Scheduled and surprise tests),
2. Closed-book and open-book tests,
3. Problem-solving exercises,
4. Practical assignments and laboratory reports,
5. Observation of practical skills,
6. Individual and group project reports like “Creating Text Editor in C”.
7. Efficient delivery using seminar presentations,
8. Viva voce interviews.
9. Computerized adaptive testing, literature surveys and evaluations,
10. Peers and self-assessment, outputs form individual and collaborative work

@ @ @ @

AG & SG SIDDHARTHA COLLEGE OF ARTS AND SCIENCES - VUYYURU.
An Autonomous college within the jurisdiction of Krishna University A.P, India.
(With Effect from Academic Year 2022-23)

MODEL Question Paper:

TITLE: Problem solving in C

CLASS B.Com(E-Commerce-Computers)

TIME: 3 Hrs.

COURSE CODE: CSCT11B

SEMESTER: III

MAX: 75M

SECTION –A

ANSWER ANY FIVE QUESTIONS

5 X 5 =25 M.

1. What is a flowchart? Utilize flowchart symbols and draw a flowchart to find biggest of two numbers. (CO1, L3)
2. Write a short note on block diagram of computers. (CO1, L2)
3. Explain do...while loop with an example program. (CO2, L2)
4. Develop a C program to find largest number in a given integer list. (CO3, L3)
5. Classify data types in C. Write a short note on any two data types. (CO2, L2)
6. How to declare and initialize 1D arrays. (CO3, L1)
7. Construct a student structure to accept student details and write a C program to calculate grade of a student. (CO4, L3)
8. Illustrate command line arguments with an example program. (CO5, L2)

SECTION – B

ANSWER ALL THE QUESTIONS

5 X 10 =50 M.

- 9 A) Define Algorithm. Demonstrate Key features of algorithm with examples. (CO1, L2)
(or)
B) List out the characteristics and limitations of computers. (CO1, L1)
- 10 A) Give Classification of Control statements in C. Explain multi-way decision making statements in C with examples. (CO2, L2)
(or)
B) Write a program to check whether the given number is Armstrong or not. (CO2, L3)
- 11 A) Develop a program in C for matrix multiplication. (CO3, L3)
(or)
B) Demonstrate various String handling functions in C with examples. (CO3, L2)
- 12 A) Compare and contrast structures with unions. (CO4, L4)
(or)
B) Explain the types of functions in C. (CO4, L2)
- 13 A) List different file handling functions in C. Explain with examples. (CO5, L2)
(or)
B) Explain call by value and call by reference with example. (CO4, L2)

AG & SG SIDDHARTHA COLLEGE OF ARTS AND SCIENCES - VUYYURU.
An Autonomous college within the jurisdiction of Krishna University A.P, India.
(With Effect from Academic Year 2022-23)

MODEL Question Paper:

TITLE: Problem solving in C

CLASS B.Com(E-Commerce-Computers)

TIME: 3 Hrs.

COURSE CODE: CSCT11B

SEMESTER: III

MAX: 75M

SECTION-A

ANSWER ANY FIVE QUESTIONS

5X5=25M

1. Unit 1
2. Unit 1
3. Unit 2
4. Unit 3
5. Unit 2
6. Unit 3
7. Unit 4
8. Unit 5

SECTION – B

ANSWER ALL THE QUESTIONS

5 X 10 =50 M.

- 9 A) Unit 1.
(or)
B) Unit 1.
- 10 A) Unit 2.
(or)
B) Unit 2.
- 11 A) Unit 3.
(or)
B) Unit 3.
- 12 A) Unit 4.
(or)
B) Unit 4.
- 13 A) Unit 5.
(or)
B) Unit 5.

AG & SG SIDDHARTHA COLLEGE OF ARTS AND SCIENCES - VUYYURU.
An Autonomous college within the jurisdiction of Krishna University A.P, India.
 (With Effect from Academic Year 2022-23)

Semester III	Course Code	Course Title	Credits	Prds
B.Com.(E-Commerce-Computers)	CSCP11B	Problem Solving in CLab	1	30

Course Outcome No	Upon successful completion of this course, students should have the knowledge and skills to:	Program Outcome No
CO1	Apply logical skills to analyse a given problem	PO1, PO7, PSO1, PSO4, PSO2
CO2	Design an algorithmic solution for a given problem	PO1, PO7, PSO1, PSO4, PSO2
CO3	Write a maintainable C program according to coding standards for a given algorithm	PO1, PO7, PSO1, PSO4, PSO2
CO4	Debug a given program	PO1, PO7, PSO1, PSO4, PSO2
CO5	Execute the C program	PO1, PO7, PSO1, PSO4, PSO2

Experiments List
Cycle-I

Week 1:

Write a C program to check whether the given two numbers are equal, bigger or smaller?

Week 2:

Write a C program to perform arithmetic operations using Switch...case?

Week 3:

- Write a program to find the sum of individual digits of a positive integer.
- Write a program to check whether the given number is Armstrong or not.

Week 4:

Write a program to generate the first N terms of the Fibonacci sequence.

Week 5:

Write a program to find both the largest and smallest number in a list of integer values

Week 6:

- Write a program that uses functions to add two matrices.
- Write a program for multiplication of two n X n matrices.

Week 7:

Write a program to demonstrate reflection of parameters in swapping of two integer values using Call by Value & Call by Address.

Week 8:

Write a program to calculate factorial of given integer value using recursive functions.

Cycle-II

Week 9:

Write a program to search an element in a given list of values.

Week 10:

Write a program to illustrate pointer arithmetic.

Week 11:

Write a program to sort a given list of integers in ascending order.

Week 12:

Write a program to calculate the salaries of all employees using Employee (ID, Name, Designation, Basic Pay, DA, HRA, Gross Salary, Deduction, Net Salary) structure.

- a. DA is 30 % of Basic Pay
- b. HRA is 15% of Basic Pay
- c. Deduction is 10% of (Basic Pay + DA)
- d. Gross Salary = Basic Pay + DA+ HRA
- e. Net Salary = Gross Salary - Deduction

Week 13:

Write a program to perform various string operations.

Week 14:

Write a program to read the data character by character from a file.

Week 15:

Write a program to create Book (ISBN, Title, Author, Price, Pages, Publisher) structure and store book details in a file and perform the following operations

- a. Add book details
- b. Search a book details for a given ISBN and display book details, if available
- c. Update a book details using ISBN
- d. Delete book details for a given ISBN and display list of remaining Books.

@@@@

A.G & S.G.SIDDHARTHA DEGREE COLLEGE OF ARTS & SCIENCE

Vuyyuru-521165.NAAC reaccredited at 'A' level

Autonomous -ISO 9001 – 2015 Certified

Title of the Paper PROGRAMMING WITH C & C++

Semester: III

Course Code	CABT31A	Course Delivery Method	Class Room / Blended Mode - Both
Credits	3	CIA Marks	25
No. of Lecture Hours / Week	4	Semester End Exam Marks	75
Total Number of Lecture Hours	60	Total Marks	100
Year of Introduction :2021	Year of Offering: 2021-22	Year of Revision: ----	Percentage of Revision: 0%

Course Objective: To learn the fundamental programming concepts and methodologies which are essential to building good C/C++ programs.

Course Outcomes:

CO ₁	To understand the meaning and generations of a programming language and to learn about c tokens.(PO5, PO7)
CO ₂	To learn about operators and conditional statements in C. (PO5, PO7)
CO ₃	To Gain knowledge about functions and to learn how to work with arrays- knowledge about strings and its functions. (PO5, PO7)
CO ₄	To learn about the concepts of structures and unions. (PO5, PO7)
CO ₅	To understand about Object-Oriented Programming concepts using CPP (PO5, PO7)

Syllabus		
Unit	Learning Units	Lecture Hours
I	INTRODUCTION TO C LANGUAGE, VARIABLES, DATA TYPES Introduction: Introduction to Programming languages and Generations of Programming languages, Structure of C Program , Writing the first C Program, Files used in C Program, Compiling and Executing C- Programs, Using Comments, Keywords, Identifiers, Basic Data Types in C, Variables- Numeric, Character, Declaring, Initializing, Constants- Integer, Float, Character, String Declaring constants, I/O Statements in C- Formatting I/O, Printf (), scanf ().	10
II	Operators: Operator and its types in C - Arithmetic, Relational, Equality, Logical, Unary, Conditional, Bitwise, Assignment, Comma, Size of. WORKING WITH CONTROL STATEMENTS, LOOPS: Introduction to Decision Control Statements , Conditional Branching Statements – If, If-Else, If-Else-if, Switch Case, Iterative or Looping Statements – While, Do-While, For , Break and Continue Statement , Go to Statement	10
III	FUNCTIONS, ARRAYS Functions : Introduction, Using Functions, Function declaration/prototype, Function Definition, Function Call, Scope of variables. Arrays : Introduction, Declaration of Arrays, Accessing elements of the Array, One dimensional array declaration and initialization with example, Two-dimensional array declaration and initialization with examples.	15
IV	STRINGS: Introduction to strings and string handling functions Structures & Unions: Introduction to structures, Structure Declaration, Typedef, Initialization, accessing the members of a structure, Nested structures, Arrays of structures, Unions – Declaring, Accessing and Initialization, Differences between Structures and Unions.	12
V	OBJECT ORIENTED CONCEPTS USING C++ Introduction to Object Oriented Programming, Object Oriented Concepts, Class-Object-Inheritance-Polymorphism- Encapsulation-Abstraction, Structure of C++ program, Differences between C & CPP, Input and output statements in CPP. Operators & Data types: Operators in CPP, Data types in CPP, Operator Overloading	13

Text Books:

	Author	Title	Publisher
1	Reema Thareja	Introduction to C programming	Oxford University Press
2	E. Balagurusamy	Objected Oriented Programming with C++	McGraw Hill.

Reference Text Books:

	Author	Title	Publisher
1	E Balagurusamy	Computing Fundamentals & C Programming	Tata McGraw-Hill, 2008
2	Ashok Kamthane	Programming with ANSI and Turbo C	Pearson Publisher, 2002.
3	Y.Kanetkar	Let Us C++:	BPB

AG & SG SIDDHARTHA COLLEGE OF ARTS AND SCIENCES - VUYYURU.
An Autonomous college within the jurisdiction of Krishna University A.P, India.
(With Effect from Academic Year 2020-21)
PROGRAMMING WITH C & C++
MODEL PAPER

CLASS: B. Com (C.A)

Course Code: CABT

Semester: III

Max. Marks: 75M

Min. Pass: 30M

Time: 3 Hours

Section A

Answer any Five of the following

5*5=25M

1. Explain the structure of a C Program. (CO1, L2)
2. Explain the working of go-to statement with example program (CO2, L2)
3. List in detail about the concept of scope of variables. (CO3, L1)
4. Define Union concept in C with example program? (CO4, L1)
5. Explain a) Encapsulation b) Abstraction concepts in CPP. (CO5, L2)
6. Demonstrate a C Program to sort the given numbers in an array. (CO3, L2)
7. Explain different types of files used in C Program. (CO1, L2)
8. Comparison between while and do-while statements. (CO2, L2)

Section B

Answer the following

5*10=50M

9. a) Explain variables and constants in C with a detailed account of types of variables and constants. (CO1, L2)

(or)

- b) Explain in detail about generations of programming languages. (CO1, L2)

10. a) Explain looping statements in C with example programs. (CO2, L2)

(or)

- b) Explain different types of operators in C language. (CO2, L2)

11. a) What is a one-dimensional array with an example program. (CO3, L1)

(or)

- b) What is a function? Explain function declaration, function definition and function calling with an example program (CO3, L1)

12. a) List any five string handling functions with syntaxes and example programs. (CO4, L1)

(or)

- b) Define array of structures in detail with an example program. (CO4, L1)

13. a) Explain structure of a C++ program in detail. (CO5, L2)

- b) Comparison between C and C++ (CO5, L2)

(or)

- c) Explain the concept of operator overloading in C++ with example. (CO5, L2)

AG & SG SIDDHARTHA COLLEGE OF ARTS AND SCIENCES - VUYYURU.
An Autonomous college within the jurisdiction of Krishna University A.P,
India.(With Effect from Academic Year 2020-21)
PROGRAMMING WITH C & C++ LAB

COMPUTER SCIENCE	CABP	2022-23	B. Com (Computer Applications)
------------------	------	---------	--------------------------------

Semester: III

Credits: 1

Hours Taught: 30 hrs. Per Semester

Max.Time: 3 Hours

Course Objective:

The purpose of this course is to introduce students to the field of programming using C language and CPP. The students will be able to enhance their analyzing and programming skills and use the same for writing their own programs in C language and Using classes in CPP language.

Course Outcomes: At the end of this course the student is able to
CO1:Use various operators in C programming
CO2:Implement decision and looping control statements

CO3:Passing parameters to functions & Accessing elements of an array and creation of one dimensional and two-dimensional arrays.

.CO4:Implementing string functions and structures, unions

concepts
CO5:Implement basic OOP concepts in CPP.

LAB LIST

1. Write a C program to calculate the expression: $((a*b)/c)+(a+b+c)$
2. Write a C program to calculate $(a+b+c)^3$
3. Write a C program to convert temperature from
 - a) Celsius to Fahrenheit
 - b) Fahrenheit to Celsius
4. Write a C program to calculate compound Interest
5. Write a C program to find biggest of three numbers
6. Write a C program to read student marks in five subjects and calculate total and average
7. Write a C program to convert hours into seconds
8. Write a C program to display number of days in given month using switch case
9. Write a C program to find biggest of two numbers using switch case
- 10 Write a C program to find whether the given number is prime or not
- 11 Write a C program to check whether the given string is palindrome or not
- 12 Write a C program to find the reverse of a given number using functions
- 13 Write a C program to swap two numbers using functions
14. Write a C program to sort the given numbers in an array
15. Write a C program to perform addition of two matrices
16. Write a C program to display student details using structures
17. Write a CPP program to find addition of three numbers using classes
18. Write a CPP program to find biggest of three numbers using classes
19. Write a CPP program to find whether a person is eligible to vote or not using classes
20. Write a CPP program to implement operator overloading concept

AG & SG SIDDHARTHA COLLEGE OF ARTS AND SCIENCES - VUYYURU.
An Autonomous college within the jurisdiction of Krishna University A.P, India.
 (With Effect from Academic Year 2021-22)

Title of the Paper: Problem solving in C

Semester: I

SECTIONS: B.Sc. (MPCS / MCCS/ MSCS)

Course Code	CSCT11B	Course Delivery Method	Class Room / Blended Mode - Both
Credits	4	CIA Marks	30
No. of Lecture Hours / Week	4	Semester End Exam Marks	70
Total Number of Lecture Hours	60	Total Marks	100
Year of Introduction :2020-21	Year of Offering: 2021 - 22	Year of Revision: Nil	Percentage of Revision: 0%

Course Objective

This course aims to provide exposure to problem-solving through programming and introduce the concepts of the C Programming language.

Course Learning Outcomes:

Course Outcome No	Upon successful completion of the course, a student will be able to:	Program Outcome No.
CO1	Understand the evolution & functionality of Digital Computers and develop an algorithm for solving a given problem.	PO1, PO7, PSO1, PSO4
CO2	Understand tokens and control structures in C.	PO1, PO7, PSO1, PSO4
CO3	Understand arrays and strings and implement them.	PO1, PO7, PSO1, PSO4
CO4	Understand the right way of using functions, pointers, structures and unions in C	PO1, PO7, PSO1, PSO4
CO5	Develop and test programs written in C files	PO1, PO7, PSO1, PSO4

UNIT I

12 periods

General Fundamentals: Introduction to computers: Block diagram of a computer, characteristics and limitations of computers, applications of computers, types of computers, computer generations.

Introduction to Algorithms and Programming Languages: Algorithm – Key features of Algorithms, Flow Charts, Programming Languages – Generations of Programming Languages – Structured Programming Language- Design and Implementation of Correct, Efficient and Maintainable Programs.

UNIT II

12 periods

Introduction to C: Introduction – Structure of C Program – Writing the first C Program –File used in C Program – Compiling and Executing C Programs – Using Comments –

Keywords – Identifiers – Basic Data Types in C – Variables – Constants – I/O Statements in C- Operators in C- Programming Examples.

Decision Control and Looping Statements: Introduction to Decision Control Statements– Conditional Branching Statements – Iterative Statements – Nested Loops – Break and Continue Statement – goto Statement.

UNIT III

10 periods Arrays:

Introduction – Declaration of Arrays – Accessing elements of the Array – Storing Values in Array– Operations on Arrays – one dimensional, two dimensional and multi-dimensional arrays, character handling and strings.

UNIT IV

14 periods Functions:

Introduction – using functions – Function declaration/ prototype – Function definition – function call – return statement – Passing parameters – Scope of variables – Storage Classes – Recursive functions.

Structure, Union, and Enumerated Data Types: Introduction – Nested Structures – Arrays of Structures – Structures and Functions– Union – Arrays of Unions Variables – Unions inside Structures – Enumerated Data Types.

UNIT V

12 periods

Pointers: Understanding Computer Memory – Introduction to Pointers – declaring Pointer Variables – Pointer Expressions and Pointer Arithmetic – Null Pointers - Passing Arguments to Functions using Pointer – Pointer and Arrays – Memory Allocation in C Programs – Memory Usage – Dynamic Memory Allocation – Drawbacks of Pointers

Files: Introduction to Files – Using Files in C – Reading Data from Files – Writing Data to Files – Detecting the End-of-file – Error Handling during File Operations – Accepting Command Line Arguments.

BOOKS

1. E Balagurusamy – Programming in ANSIC – Tata McGraw-Hill publications.
2. Brain W Kernighan and Dennis M Ritchie - The ‘C’ Programming language” - Pearson publications.
3. Ashok N Kamthane: Programming with ANSI and Turbo C, Pearson Edition Publications.
4. YashavantKanetkar - Let Us ‘C’ – BPB Publications.

RECOMMENDED CO-CURRICULAR ACTIVITIES:

(Co-curricular activities shall not promote copying from textbook or from others work and shall encourage self/independent and group learning)

A. Measurable

1. Assignments (in writing and doing forms on the aspects of syllabus content and outside the syllabus content. Shall be individual and challenging)
2. Student seminars (on topics of the syllabus and related aspects (individual activity))
3. Quiz (on topics where the content can be compiled by smaller aspects and data (Individuals or groups as teams))
4. Study projects (by very small groups of students on selected local real-time problems pertaining to syllabus or related areas. The individual participation and contribution of students shall be ensured (team activity

B. General

1. Group Discussion
2. Try to solve MCQ’s available online.
3. Others

RECOMMENDED CONTINUOUS ASSESSMENT METHODS:

Some of the following suggested assessment methodologies could be adopted;

1. The oral and written examinations (Scheduled and surprise tests),
2. Closed-book and open-book tests,
3. Problem-solving exercises,
4. Practical assignments and laboratory reports,
5. Observation of practical skills,
6. Individual and group project reports like “Creating Text Editor in C”.
7. Efficient delivery using seminar presentations,
8. Viva voce interviews.
9. Computerized adaptive testing, literature surveys and evaluations,
10. Peers and self-assessment, outputs form individual and collaborative work

AG & SG SIDDHARTHA COLLEGE OF ARTS AND SCIENCES - VUYYURU.
An Autonomous college within the jurisdiction of Krishna University A.P, India.
(With Effect from Academic Year 2021-22)

BLUE PRINT

TITLE: Problem solving in C
SECTIONS: B.Sc. (MPCS / MCCS / MSCS)
TIME: 3 Hrs.

COURSE CODE: CSCT11B
SEMESTER: I
MAX: 70M

SECTION-A

ANSWER ALL QUESTIONS

5X14=70M

1. a. Unit 1(10M)
b. Unit 1(4M)
OR
c. Unit 1(10M)
d. Unit 1(4M)
2. a. Unit 2(10M)
b. Unit 2(4M)
OR
c. Unit 2(10M)
d. Unit 2(4M)
3. a. Unit 3(10M)
b. Unit 3(4M)
OR
c. Unit 3(10M)
d. Unit 3(4M)
4. a. Unit 4(10M)
b. Unit (4M)
OR
c. Unit 4(10M)
d. Unit 4(4M)
5. a. Unit 5(10M)
b. Unit 5(4M)
OR
c. Unit 5(10M)
d. Unit 5(4M)

AG & SG SIDDHARTHA COLLEGE OF ARTS AND SCIENCES - VUYURU.
An Autonomous college within the jurisdiction of Krishna University A.P, India.
 (With Effect from Academic Year 2021-22)

Semester I	Course Code	Course Title	Credits	Prds
B.Sc.(MPCS / MCCS/ MSCS)	CSCP11B	Problem Solving in C Lab	1	30

Course Outcome No	Upon successful completion of this course, students should have the knowledge and skills to:	Program Outcome No
CO1	Apply logical skills to analyse a given problem	PO1, PO7, PSO1, PSO4, PSO2
CO2	Design an algorithmic solution for a given problem	PO1, PO7, PSO1, PSO4, PSO2
CO3	Write a maintainable C program according to coding standards for a given algorithm	PO1, PO7, PSO1, PSO4, PSO2
CO4	Debug a given program	PO1, PO7, PSO1, PSO4, PSO2
CO5	Execute the C program	PO1, PO7, PSO1, PSO4, PSO2

**Experiments List
Cycle-I**

Week 1:

Write a C program to check whether the given two numbers are equal, bigger or smaller?

Week 2:

Write a C program to perform arithmetic operations using Switch...case?

Week 3:

- Write a program to find the sum of individual digits of a positive integer.
- Write a program to check whether the given number is Armstrong or not.

Week 4:

Write a program to generate the first N terms of the Fibonacci sequence.

Week 5:

Write a program to find both the largest and smallest number in a list of integer values

Week 6:

- Write a program that uses functions to add two matrices.
- Write a program for multiplication of two n X n matrices.

Week 7:

Write a program to demonstrate reflection of parameters in swapping of two integer values using Call by Value & Call by Address.

Week 8:

Write a program to calculate factorial of given integer value using recursive functions.

Cycle-II

Week 9:

Write a program to search an element in a given list of values.

Week 10:

Write a program to illustrate pointer arithmetic.

Week 11:

Write a program to sort a given list of integers in ascending order.

Week 12:

Write a program to calculate the salaries of all employees using Employee (ID, Name, Designation, Basic Pay, DA, HRA, Gross Salary, Deduction, Net Salary) structure.

- a. DA is 30 % of Basic Pay
- b. HRA is 15% of Basic Pay
- c. Deduction is 10% of (Basic Pay + DA)
- d. Gross Salary = Basic Pay + DA+ HRA
- e. Net Salary = Gross Salary - Deduction

Week 13:

Write a program to perform various string operations.

Week 14:

Write a program to read the data character by character from a file.

Week 15:

Write a program to create Book (ISBN, Title, Author, Price, Pages, Publisher) structure and store book details in a file and perform the following operations

- a. Add book details
- b. Search a book details for a given ISBN and display book details, if available
- c. Update a book details using ISBN
- d. Delete book details for a given ISBN and display list of remaining Books.

AG & SG SIDDHARTHA COLLEGE OF ARTS AND SCIENCES - VUYYURU.
An Autonomous college within the jurisdiction of Krishna University A.P, India.
(With Effect from Academic Year 2021-22)

Title of the Paper: INFORMATION TECHNOLOGY

Semester: I

SECTIONS: B.Com (CA)

Course Code	CSBT11A	Course Delivery Method	Class Room / Blended Mode - Both
Credits	4	CIA Marks	30
No. of Lecture Hours / Week	5	Semester End Exam Marks	70
Total Number of Lecture Hours	60	Total Marks	100
Year of Introduction :2020-21	Year of Offering: 2021 - 22	Year of Revision: ----	Percentage of Revision: 0%

INFORMATION TECHNOLOGY

Objective:

It provides to learn computer basics and basic principles of using Windows operation system and be able to access the Internet, data communication, Software, hardware and various new technologies in information technology.

Course Outcomes:

COURSE OUTCOME NO	Upon successful completion of this course, students should have the knowledge and skills to
CO1	Understand fundamental concepts of a computer and its basic components
CO2	Understand basic functioning of an operating system and customizing Windows Desktop
CO3	Analyse type of soft wares and programming languages
CO4	Have knowledge in basic Network and Data Communication Concepts
CO5	Understand the need of data mining and get familiarize with basics of new concepts like KDD, OLAP

UNIT-I: INTRODUCTION:

13Periods

Introduction to computers
 Generations of computers
 An overview of computer system - Types of computers
 Input & Output Devices.

Hardware: Basic components of a computer system- Control unit– ALU- Input/outputfunctions.
 Memory – RAM – ROM – EPROM - PROM and Other types of memory.

UNIT-II: OPERATING SYSTEM (OS):

12Periods

Meaning - Definition & Functions.
 Types of OS - Booting process

DOS – Commands (internal & external) - Wild card characters

Windows: Using the Start Menu –Control Panel – Using multiple

Windows – Customizing the Desktop – Windows accessories (Preferably latest version of windows or Linux Ubuntu).

Unit-III: SOFTWARE:**15Periods**

System software and application software.
Operating system windows OS,
Mobile device operating system and notebook operating systems
Application software Types of personal application software
Spread sheet-data management
Word processing
Desktop publishing
Graphics, CAD, CAM, CIM
Programming Languages
Assembly language
Procedural language, non-procedural language, natural programming language.
Hypertext mark-up language, modelling language, object-oriented programming language.

Unit-IV: DATA COMMUNICATION:**20 Periods**

Telecommunication and Networks Communication media& channel cable media
Broad cast media channels twisted pair
Coaxial cable, fibers optical cable, micro wave, satellite, radio, cellular radio, infrared global positioning system.
Introduction, Analog and Digital signals, modulation need of modulations, modems.
Telecommunication System communication processors:
Modem
Multiplexers
Front –end-processor.
Networks LAN, WAN, VAN, virtual private network (VPN).
Internet, intranet and Extranets
The evolution of the internet, service provided by the internet, World Wide Web.

Unit-V: NEW TECHNOLOGIES:**10 Periods**

New technologies in Information Technology:
Introduction to hyper media, artificial intelligence and business intelligence, knowledgediscovery in database (KDD)
Data warehouse and data marts. Data mining and OLAP.

Student Activity:

Students have to submit assignments and give seminars on various topics allotted to them.

Total of 5 Hrs is allotted for student seminars. Student activity also includes gathering of information related to latest technologies in computers.

Library Activity:

Students will visit library in their allotted time and will refer various text books to gather information for their assignments.

TEXT/ REFERENCE BOOKS:

1. B.E.V.L.Naidu, V.V.. Devi Prasad Konti, Ganti Naga Srikanth, Himalaya publishing House.
2. Introduction to Computers: Peter Norton, McGraw Hill.

AG & SG SIDDHARTHA COLLEGE OF ARTS AND SCIENCES - VUYYURU.
An Autonomous college within the jurisdiction of Krishna University A.P, India.
(With Effect from Academic Year 2021-22)

Model Paper

TITLE: INFORMATION TECHNOLOGY
CLASS B.Com(CA)
TIME: 3 Hrs.

COURSE CODE: CSBT11A
SEMESTER: I
MAX: 70M

SECTION-A

ANSWER ALL QUESTIONS

5X14=70M

6. a. Unit 1(10M)
e. Unit 1(4M)
OR
f. Unit 1(10M)
g. Unit 1(4M)
7. a. Unit 2(10M)
e. Unit 2(4M)
OR
f. Unit 2(10M)
g. Unit 2(4M)
8. a. Unit 3(10M)
e. Unit 3(4M)
OR
f. Unit 3(10M)
g. Unit 3(4M)
9. a. Unit 4(10M)
e. Unit 4(4M)
OR
f. Unit 4(10M)
g. Unit 4(4M)
10. a. Unit 5(10M)
e. Unit 5(4M)
OR
f. Unit 5(10M)
g. Unit 5(4M)

A.G & S.G.SIDDHARTHA DEGREE COLLEGE OF ARTS & SCIENCE

Vuyyuru-521165. NAAC reaccredited at 'A' level

*Autonomous -ISO 9001 – 2015 Certified*Title of the Paper: **COMPUTER APPLICATIONS**

Semester: I

Course Code	CCSE101	Course Delivery Method	Class Room / Blended Mode –
Credits	3	CIA Marks	30
No. of Lecture Hours / Week	4	Semester End Exam Marks	70
Total Number of Lecture Hours	60	Total Marks	100
Year of Introduction :2020-21	Year of Offering: 2022-23	Year of Revision: ----	Percentage of Revision: 0%

COURSE OBJECTIVES:

It provides to learn computer basics and basic principles of using Windows operation system and be able to access the Ms-Office, Power Point, Excel and various new technologies in information technology.

Course Outcomes:

COURSE OUTCOME NO	Upon successful completion of this course, students should have the knowledge and skills to
CO1	Understand fundamental concepts of a computer and its basic components
CO2	Understand basic functioning of an Ms-Office and MS-Word Window Components Windows Desktop
CO3	Analyze type of soft ware's and programming languages
CO4	Have knowledge in MS-Excel and MS Access
CO5	Understand the need of Finding, Sorting and Displaying Data and get familiarize

AG & SG SIDDHARTHA COLLEGE OF ARTS AND SCIENCES - VUYYURU.

An Autonomous college within the jurisdiction of Krishna University A.P, India.

(With Effect from Academic Year 2021-'22)

COMPUTER SCIENCE	CCSE101	2022-23	B.Com(E-Commerce-Computes)
SEMESTER – I PAPER – I	Max. Marks 70	Pass Marks 28	Total Hrs: 60

Syllabus: Computer Applications

NO. Of Hrs: 4

Credits: 3

Unit-I: MS-Word

10 Hrs

Features of MS-Word – MS-Word Window Components – Creating, Editing, Formatting and Printing of Documents – Headers and Footers – Insert/Draw Tables, Table Auto format – Page Borders and Shading – Inserting Symbols, Shapes, Word Art, Page Numbers, Equations – Spelling and Grammar – Thesaurus – Mail Merge

Unit-II: MS-PowerPoint

10 Hrs

Features of PowerPoint – Creating a Blank Presentation - Creating a Presentation using a Template - Inserting and Deleting Slides in a Presentation – Adding Clip Art/Pictures - Inserting Other Objects, Audio, Video - Resizing and Scaling of an Object – Slide Transition – Custom Animation

Unit-III: MS-Excel

10Hrs

Overview of Excel features – Creating a new worksheet, Selecting cells, Entering and editing Text, Numbers, Formulae, Referencing cells – Inserting Rows/Columns – Changing column widths and row heights, auto format, changing font sizes, colors, shading and attributes – Data Sorting and Filters – Functions – Functions requiring Addins, Functions by category Creating different types of Charts

Unit-IV: MS Access:

12Hrs

Creating a Simple Database and Tables: Features of Ms-Access, Creating a Database, Parts of Access. Tables: table creation using design view, table wizard, data sheet view, import table, link table. Forms: The Form Wizard, design view, columnar, tabular, data sheet, chart wizard.

Unit- V: Finding, Sorting and Displaying Data:

12Hrs

Queries and Dynasts, Creating and using select queries, Returning to the Query Design, Multi-level sorts, Finding incomplete matches, showing All records after a Query, saving queries - Crosstab Queries. Printing Reports: Form and Database Printing..

Reference Books:

- 1.Ron Mansfield, Working in Microsoft Office, Tata McGraw Hill(2008)
- 2.Ed Bott, Woody Leonhard, Using Microsoft Office 2007, Pearson Education(2007)
3. Sanjay Saxsena, Microsoft Office, 4.Microsoft Office, BPB Publications

AG & SG SIDDHARTHA COLLEGE OF ARTS AND SCIENCES - VUYYURU.
An Autonomous college within the jurisdiction of Krishna University A.P, India.
(With Effect from Academic Year 2021-22)

Model Paper

TITLE: COMPUTER APPLICATIONS
SECTIONS: B.Com(E-Commerce-Computers)
TIME: 3 Hrs.

COURSE CODE: CSCE101
SEMESTER: I
MAX: 70M

SECTION-A

ANSWER ALL QUESTIONS

5X14=70M

1. a. Unit 1(10M)
b. Unit 1(4M)
OR
c. Unit 1(10M)
d. Unit 1(4M)

- 2 a. Unit 2(10M)
b. Unit 2(4M)
OR
c. Unit 2(10M)
d. Unit 2(4M)

- 3 a. Unit 3(10M)
b. Unit 3(4M)
OR
c. Unit 3(10M)
d. Unit 3(4M)

- 4 a. Unit 4(10M)
b. Unit 4(4M)
OR
c. Unit 4(10M)
d. Unit 4(4M)

- 5 a. Unit 5(10M)
b. Unit 5(4M)
OR
c. Unit 5(10M)
d. Unit 5(4M)

AG & SG SIDDHARTHA COLLEGE OF ARTS AND SCIENCES - VUYYURU.

An Autonomous college within the jurisdiction of Krishna University A.P, India.

(With Effect from Academic Year 2019-'20)

COMPUTER SCIENCE	CCSEP-101	2022-23	B.Com. (E-COMMERCE)	
SEMESTER – I	PAPER – I	Max. Marks 50	Pass Marks 20	Total Hrs: 30

COMPUTER APPLICATIONS LAB

Ms-Word

1. Create a vesting Card
2. Create a template for organization using Header & Footer
3. Inserting tables, pictures, Charts
4. Macros
5. Mail merge Procedure

Ms-Excel

1. Create an electronic spreadsheet in which you enter the following decimal numbers and convert into Octal, Hexadecimal and Binary numbers vice versa. Decimal Numbers: 35, 68, 95, 165, 225, 355, 375, 465. Binary Numbers: 101, 1101, 111011, 10001, 110011001, 111011111.
2. The ABC Company shows the sales of different products for 5 years. Create column chart, 3D-column and Bar chart for the following data
YEAR PRODUCT-1 PRODUCT-2 PRODUCT-3 PRODUCT-4
2003 1000 800 900 1000
2004 800 80 500 900
2005 1200 190 400 800
2006 400 200 300 1000
2007 1800 400 400 1200
3. Create a suitable examination data base and find the sum of the marks(total) of each student and respective class secured by the student rules:
Pass if marks in each subject ≥ 35 Distinction if average ≥ 75 First class if average ≥ 60 but < 75
Second class if average ≥ 50 but < 60 Third class if average ≥ 35 but < 50
Fail if marks in any subject is < 35 Display average marks of the class, subject wise and pass percentage
4. Create an electronic spread sheet in which you enter date and time functions in Excel
5. Create a electronic spread sheet in statistical and mathematical functions in Excel

MS-PowerPoint

1. Make a Power point presentation on your strengths, weaknesses, hobbies, factors that waste your time.
2. Make a Power point presentation to represent your College profile.
3. Make a Power point presentation of all the details of the books that you had studied in B.Sc. First Year.
4. Create a Presentation without Animation.

MS-ACCESS

1. Create a database using MS-ACCESS with at least 5 records table1 structure: register number , name, dob, gender, class table2 structure: register number m1 m2 m3 m4 m5 total maintain the relationship between two tables with register number as a primary key and answer the following quarries: show the list of students with the following fields as one query register number name gender total marks
2. Maintain the relationship between above two tables with register number as a primary key and answer the following reports: reports must have following columns report1 with register number, name, marks of all subjects and 90 hrs (3 hrs/ week) computer science 10 of 44 total report2 with register number, total , percentage.
3. Create a database using ms-access with at least 5 records table1 structure: emp-code emp-name age gender dob table2 structure: emp-code basic-pay maintain the relationship between two tables with emp-code as a primary key generate the following reports: report1: emp-code emp-name basic-pay da,hra gross-salary report2: emp-code emp-name age gender gross-salary.

**A.G& S.G.SIDDHARTHA DEGREE COLLEGE OF ARTS &
SCIENCE**

VUYYURU-521165, KRISHNA Dt., A.P.(Autonomous)

Accredited by NAAC with "A" Grade

2022-2023



DEPARTMENT OF ECONOMICS

MINUTES OF BOARD OF STUDIES

ODD SEMESTER

28-10-2022

**AG&SG SIDDHARTHA DEGREE COLLEGE OF ARTS and
SCIENCE(AUTONOMOUS) VUYURU**

ACEDAMIC YEAR - 2022 - 2023

Minutes of the meeting of the Board of Studies in Economics of AG & SG Siddhartha Degree College of Arts & Science, Vuyyuru, held at 11.00 A.M ON 28-10 – 2023 In the Department of Economics Through online Mode.

Sri.N.Rama Raol, HOD, Economics has Presided over the BOS meeting

Members Present:

- 1) N. Rama Rao Chairman Head, Department of Economics
(Sri.N.Rama Rao) AG & SG S Degree College of Arts & Science
Vuyyuru-521165

- 2) G. Nirmala Jyothi University Head Department of Economics
(Mrs G.Nirmala Jyothi) Nominee S.A.S. Government Degree College
Narayana Puram

- 3) D. Aruna Academic Council Head, Department of Economics
(D.Aruna) Nominee SDMS Mahila Kalasala, Vijayawada

- 4) G. Suresh Babu Academic Council Lecturer in Economics ,
(G.Suresh Babu) Nominee V.S.R. Government Degree College,
Movva

AGENDA

1. To Review and recommend any changes in the syllabi , Model Question Papers and Guidelines of 1st, 3rd and 5th Semesters of I, II and III Year B.A Economics Papers for the Academic Year 2022 - 2023.

2. To Discuss and recommend the pattern of internal Assessment , Guidelines and Model Question Papers in 1st, 3rd and 5th Semesters of B.A Degree Economics papers for the Academic Year 2022-2023.

3. To Recommend the guidelines to be followed by the Question Paper Setters in Economics for the 1st, 3rd and 5th Semester-end exams.

4. To Recommend the teaching and evaluation methods to be followed under the Autonomous Status.

5. To Propose the panel of Question paper setters and Examiners.

6. To Suggest innovative methods of teaching.

7. Any other matter.

RESOLUTIONS:

- 1) It is resolved to continue the same syllabi under CBC System approved by the Academic council of 2020- 2021 for I and III Semesters of I and II B,A Classes for the 2022-2023 Academic year also

The APSHE was introduced Two New Subjects and New syllabus in the V Semester of III Degree B.A from the Academic year 2022 – 2023.

- 2) Out of maximum 100 marks in each paper 30 marks shall be allocated for Internal Assessments regarding I and V Semesters.
 - A) To implement 30 marks for internal assessment and 70 marks for External Assessment from the academic year 2019-20 and that is also implemented to the I and V Semesters from 2020-21 Academic year 2021 – 2022 Academic year and 2022 – 2023 Academic year also.
 - B) Out of these 30 marks, 20 marks are allocated for internal tests, 5 marks are allocated for assignment for I and V Semesters. The two tests will be conducted and average of these two tests shall be deemed as the marks obtained by a student, and remaining 5 marks are allocated for attendance/Activity.

3) Out of maximum 100 marks 25 Marks shall be allocated for Internal Assessments Regarding the III Semester from the Academic year 2022 – 2023.

A) To implement 25 Marks for Internal Assessments and 75 Marks for External Assessment regarding the III Semester from the Academic year 2022 – 2023.

B) Out of these 25 marks, 15 Marks are allocated for internal tests, 5 marks are Allocated for assignment and 5 Marks for activity Regarding the III Semester from the Academic year 2022 – 2023.

- 4) Discussed and recommended the syllabi, Model question papers under CBC system and guidelines to be followed by the question paper setters of I,III and V semesters of B.A Classes for the Academic year 2022-2023.
- 5) To follow the teaching and evaluation methods, it is also resolved to use various other methods like Group discussions, Quiz, Organizing Seminars, Guest Lectures and Workshops to upgrade the knowledge of the students and impart new skills of learning as frequently as possible.

Resolved to authorize the chairman of Board of studies to suggest the panel of paper setters and Examiners to the controller of Examinations as for the requirement.

6) The APSHE was introduced new skill development course financial markets in the 3rd semester for 2nd B.A Students from the academic year 2021-2022. No internal Examination for this paper only External Examination will be conducted for 50 Marks
But the question paper setting pattern is changed from Academic year 2022-2023. 10 marks Allocated for internal Examinations and 40 marks Allocated for External Examinations

- 7) The APSHE was introduced Two New choice Subjects i.e. Insurance Services and Banking and Financial Services in the V Semester of III Degree B.A from the Academic year 2022 – 2023. It is resolved to Follow the APSCHE New syllabus in the V Semester of III Degree B.A from the Academic year 2022 – 2023. Internship in V Semester and new syllabus is followed in VI semester.

It is resolved to follow further changes if any in the syllabus by the competent Authority.

Chairman

(A Statutory body of the Government of Andhra Pradesh)
REVISED UG SYLLABUS UNDER CBCS
(To Be Implemented from Academic Year 2022-23)
PROGRAMME: FOURYEAR B.A. (Hons)
Domain Subject: ECONOMICS

Skill Enhancement Courses (SECs) for Semester V
(Syllabus with Learning Outcomes, References, Co-curricular Activities & Model
Q.P.
Pattern)

Structure of SECs for 5th Semester
(To Choose One pair from the Four (A, B, C, & D) alternative pairs of SECs)

Unl Code	Course Number 6 & 7	Name of Course	Hours/Week	Credits	Marks	
					IA – 20 Fieldwork/Project work 5	Sem End
	6A	Rural Entrepreneurship	5	4	25	75
	7A	Farmer Producer Organizations	5	4	25	75
OR						
	6B	Urban Entrepreneurship and MSMEs	5	4	25	75
	7B	Retail and Digital Marketing	5	4	25	75
OR						
	6C	Insurance Services	5	4	25	75
	7C	Banking and Financial Services	5	4	25	75
OR						
	6D	Inferential Statistics and Software Packages	5	4	25	75
	7D	Project Designing and Report Writing	5	4	25	75

***Note-1:** For Semester-V, for the domain subject, Economics, any one of the four pairs of SECs shall be chosen as courses 6 and 7, i.e., 6A & 7A or 6B & 7B or 6C & 7C or 6D & 7D. The pair shall not be broken (ABCD allotment is random, not on any priority basis).*

***Note-2:** One of the main objectives of Skill Enhancement Courses (SEC) is to inculcate skills related to the domain subject among students. The syllabus of SEC will be partially skill oriented. Hence, teachers shall also impart practical training to students on the skills embedded in syllabus citing related real field situations*

SEMESTER -I

Course Code	Title of the Course	Instruction Hours per week	Credits	Evaluation		
				CIA MARKS	SEE	
		MARKS			DURATION	
(ECO T11B)	MICROECONOMIC ANALYSIS	5	4	30	70	3 Hrs.

SEMESTER –III

Course Code	Title of the Course	Instruction Hours per week	Credits	Evaluation		
				CIA MARKS	SEE	
					MARKS	DURATION
(ECO T31B)	DEVELOPMENT- ECONOMICS	5	4	25	75	3 Hrs.
(SDC ECO T01)	FINANCIAL MARKETS (SDC)	2	2	10	40	2 Hrs.

SEMESTER -V/VI

Course Code	Title of the Course	Instruction Hours per week	Credits	Evaluation		
				CIA MARKS	SEE	
		MARKS			DURATION	
ECO – 501C	INSURANCE SERVICES	5	4	30	70	3 Hrs.
ECO – 502C	BANKING AND FINANCIAL SERVICES	5	4	30	70	3 Hrs.

A.G&SG SIDDHARTHA DEGREE COLLEGE OF ARTS & SCIENCE

(An Autonomous College in the Jurisdiction of Krishna University)

Siddhartha Nagar, Vijayawada – 520 010

Autonomous -ISO 9001 - 2015 Certified

I B.A (HEP) – SEMESTER-I MICRO ECONOMIC ANALYSIS (ECOT11B)

No of Hours per week : 5

Credits :4

Course Outcomes : At the end of this course, students should be able to:

CO1 : Students are able to understand fundamentals of microeconomics

CO2 : Students are able to understand the behavior of consumer.

CO3 : Students are able to understand the behavior of producer.

CO4 : Student can evaluate the different market structures.

CO5 : Students can analyze the different theories of distribution.

Syllabus

Unit	Learning Units
I	ECONOMIC ANALYSIS AND METHODOLOGY : Definitions of Economics-Wealth Definition, Welfare Definition, Scarcity Definition, Growth Oriented Dynamic Definition Methodology in Economics - Micro and Macro Economics, Deductive and Inductive Methods, Production Possibility Curve (PPC)
II	THEORY CONSUMPTION: Demand Analysis- Concept & Factors Determining Demand, Law of Demand and Exceptions. Elasticity of Demand - Types of Price Elasticity of Demand, Methods to Measure Price Elasticity of Demand. Indifference Curve Analysis - Indifference Schedule & Indifference map, Marginal Rate of Substitution, Properties of Indifference curves, Budget line & Consumers Equilibrium through Indifference Curve, Consumer's Surplus through Indifference Curve Analysis
III	THEORY OF PRODUCTION: Concept of Production Function-Cobb-Douglas Production Function, The law of variable proportions, The law of Return to Scale, Economies of large Scale Production. Concepts of cost - Short run Cost Curves. Law of supply. Revenue Concepts - (T.R., A.R. & M.R), Relationship between AR, MR & E.D, Cost minimization, Profit Maximization.
IV	THEORY OF EXCHANGE : Classification of Markets, Features of Perfect Market Conditions, Price Determination under Perfect Competition Market, Features of Monopoly Market, Features of Monopolistic Competition Market, Features of Oligopoly Market, Kinky Demand Curve Analysis
V	THEORY OF DISTRIBUTION : Concepts of Functional and Personal Distribution. Marginal Productivity Theory of Distribution. Theories of Rent-Ricardian Theory of Rent, Marshall's Economic rent. Theories of Wages - Standard of Living Theory of wages, Modern Theory of wages. Theories of Interest - Classical Theory of Interest, Loanable Funds Theory of Interest, Keynes Liquidity Preference Theory of Interest. Theories of Profit - Risks Theory of Profit, Uncertainty Theory of Profit, Dynamic Theory of Profit, Innovation Theory of Profit

Textbook:

Micro Economics, Telugu Akademi Publications.

Recommended Reference book:

H.L. Ahuja – Advanced Economic Theory - S.Chand & Company Publishers

H.S. Agarwal – Principles of Economics

M.L. Seth – Micro Economics, Lakshmi Narayana Agarwal Publishers

A.W. Stonier & D.C Hague – A Text Book of Economic Theory, E.L.B.S

Koutsoyiannis : Modern Micro Economics, Mc. Millan

Course Delivery method : Face-to-face

Course has focus on :

Foundation

Websites of Interest :

1. <https://www.economicnetwork.ac.uk/teaching/simulations/principlesofmicroeconomics.htm>
2. <http://xlab.berkeley.edu/>

Co-curricular Activities:

1. Student Seminar on Microeconomic Analysis.
2. Quiz to test critical understanding of the fundamentals of microeconomic analysis.
3. Group discussion on the different market structures.
4. Poster presentation.

A.G & S.G Siddhartha Degree College of Arts and Science (Autonomous)
Vuyyuru - 521165

SEMESTER – I

MODEL PAPER (W.E.F 2022 – 2023)

Course Code: ECOTIIB Course Title : Micro Economic Analysis
SEMESTER – I BA w.e.f. 2022 -23
Model Question Paper
Time: 3 Hours Max. Marks : 70M

Time:3Hrs

Max.Marks:70M

Section – A

Answer all questions. All questions carry equal marks. 5x14 = 70M

1. A (i) Critically examine the Robbins Scarify definition toEconomics L1 10M
(or)

(ii) Distinguish between micro and macro Economics L1 10M

B (i) Write about the deductive method L2 4M
(or)

(ii) Explain the production possibility curve L2 4M

2. A (i) Explain the various types of price elasticities of demand L2 10M
(or)

(ii) Explain the properties of indifference curves L2 10M

B (i) What are the exceptions to the law of demand? L2 4M
(or)

(ii) Explain the concept of marginal rate of substitution L2 4M

3. A (i) Explain the Law of variable proportions L2 10M
(or)

(ii) Explain the relationship between different short runcost curves L2 10M

B (i) Explain the Cobb-Douglas production function L3 4M
(or)

(ii) Explain the mathematical relationship between AR, MR and Electricity of demand
L3 4M

4. A (i) Explain the price determination and under perfect competition market
L2 10M

(or)

(ii) Explain the kinky demand curve analysis L2 10M

B (i) Write about the classification of markets L2 4M
(or)

(ii) Explain the features of monopoly market L2 4M

5. A (i) Critically examine the Ricardian theory of Rent L2 10M
(or)

(ii) Critically examine the Keynes liquidity preference theory of interest L2 10M

B (i) Explain the standard of living theory of wages L2 4M
(or)

(ii) Explain the J.B. Clark's Dynamic theory of profit L2 4

A.G & S.G Siddhartha Degree College of Arts and Science (Autonomous)

Vuyyuru - 521165

(An Autonomous College in the Jurisdiction of Krishna University)

II B.A (HEP) – SEMESTER-III

Development Economics

(ECOT31B)

No of Hours per week : 5

Credits :4

Course Outcomes : At the end of this course, students should be able to:

CO1 : To acquire the knowledge about the scope, importance of economic growth and economic development

CO2 : To acquire the knowledge about the modern theories of economic growth

CO3 : To acquire the knowledge about the theories of Development and under Development

CO4 : To acquire knowledge about the strategies of economic development

CO5 : To acquire knowledge about the role of institutions in economic development

UNIT –I ECONOMIC GROWTH AND DEVELOPMENT

Introduction to Economic growth and development, Emergence of Economic development as a branch of Economics, Scope and Importance of Economic Development- *Desirability of Economic Development, Nature Of Development Problem, Nature of Economic Growth.* Meaning and Definitions of Economic growth and Economic development, Measurement of Economic Development and their limitations, Indicators of Economic Development, Economy and Environment, Concept of Green GDP, Sustainable Development and Inclusive Growth

UNIT – II MODERN ECONOMIC GROWTH

Meaning and definitions of Modern Economic Growth, World Bank(IBRD) classification of countries, International Monetary Fund(IMF) classification of countries, Simon Kuznets' Six characteristics of Modern Economic Growth, Obstacles to Economic Development- *Vicious Circle of Poverty, Market Imperfections, Economic and Non-Economic obstacles, Impact of International Trade and Colonialism.*

Factors of Governing Economic Development

UNIT – III THEORIES OF DEVELOPMENT AND UNDER DEVELOPMENT

Classical theories of Economic Development- Adam Smith's theory of Economic Growth, Ricardian theory of Economic Growth, Malthusian theory of Economic Growth, Marxian theory of Economic Development, Schumpeter theory of Economic Development, **Theories/Models of Economic Growth** - W.W. Rostow stages of Economic Growth, Harrod-Domar Two sector growth model, R.M. Solow Model of Economic Growth, Joan Robinson's Golden Age of Economic Growth

UNIT – IV STRATEGIES OF ECONOMIC DEVELOPMENT

Introduction to growth strategies/models- Big Push Theory (Rodon's Theory), The Theory of Balanced Growth, The Theory of Unbalanced Growth, Mahalanobis Model of Economic Growth. **Techniques for Economic Development** - Agriculture vs. Industry, Capital Intensive Techniques vs Labour Intensive Techniques, Role of Infrastructure in Economic Development

UNIT – V INSTITUTIONS AND ECONOMIC DEVELOPMENT

Meaning of Market Economy and State Economy - Role of market and reasons for market failure, Role of state regulation on economic systems and problems, Interdependence of market and state, Public sector vs private sector. **Economic Planning** - Concept and Objectives of Economic Planning, Types of Economic Planning, NITI Aayog. **Economic Federalism and Financial Institutions in Economic Development** - Role of Financial institutions in Economic Development, Role of World Bank (IBRD) in Economic Development, Role of Asian Development Bank (ADB) in Economic Development, Role of International Monetary Fund (IMF) in Economic Development, Role of Foreign Trade in Economic Development, Concept of FIIs and FDIs in Economic Development

Textbook:

Indian Economy, Telugu Akademi Publications

Recommended Reference book:

- 1.Dhingra, I.C - "Indian Economy", Sultan Chand, 2014.
- 2.Ruddar Dutt and K.P.M. Sundaram - "Indian Economy", S.Chand & Co., 2015.
- 3.G.M.Meier -"Leading Issues in Economic Development", Oxford University Press, New York,.
- 4.M.P.Todaro - "Economic Development", Longman, London 6/e, 1996.
- 5.Reserve Bank of India – “Hand book of Statistics on Indian Economy” (Latest).
- 6.S.K.Misra & V,K,Puri - "Indian Economy", Himalaya Publishing House, 2015.
- 7.R.S.Rao, V.Hanumantha Rao & N.Venu Gopal (Ed) – “Fifty Years of Andhra Pradesh (1956-2006)”, Centre for Documentation, Research and Communications, Hyderabad, 2007.
- 8.G.Omkarnath – “Economics - A Primer for India” - Orient Blackswan, 2012.
- 9.Benjamin Higgins - Economic Development

Course Delivery method : Face-to-face

Course has focus on :

Foundation

Websites of Interest :

1. <https://www.adb.org/countries/india/economy>
2. <https://www.indiabudget.gov.in/economicssurvey/>
3. <https://www.imf.org/en/Countries/IND>
4. <https://www.investopedia.com/terms/d/development-economics.asp>

Co-curricular Activities:

1. Assignments on the models and the strategies of economic development adopted in Indian Economy.
2. Student Seminar on development oriented themes relating to Indian Economy.
3. Quiz to test critical understanding of the fundamental concepts of growth and development and the growth models and strategies.
4. Group discussion on the effectiveness of the roles played by various institutions in India's economic development
5. Group project work to examine specific aspects of growth like poverty, unemployment, human development, gender development as Indian Experience in the context of economic development preferably at the state and local level.
6. Poster presentation.

A.G & S.G Siddhartha Degree College of Arts and Science (Autonomous)
Vuyyuru - 521165

II B.A (HEP) – SEMESTER-III
DEVELOPMENT ECONOMICS
(ECOT31B)
Model Question Paper

TIME : 3 HRS

Max.: 75 Marks

Section-A

Answer Any Five of the Following

(5 x 5M = 25Marks)

1. Distinguish between Economic Growth and Economic Development L1
□□□□□ □□□□□ □□□□ □□□□□□□□□□□□□□□□ □□□□ □□□□□□□□□□□
2. Explain the concept of sustainable development L1
□□□□□□□□□□□□□□ □□□□□ □□□□□ □□□□□□□□□□□
3. Explain the World Bank classification of the countries L3
□□□□□□ □□□□□□□ □□□□□ □□□□□ □□□□□□□□□□□ □□□□□□□□□□□
4. Explain the vicious circle of poverty L2
□□□□□□ □□□□□□□□□□□ □□□□□□□□□□□
5. Explain the W.W. Rostow stages of economic growth L3
□□□□□□□□□□□□□□□□□□□□ W. W. □□□□□□□□ □□□□□ □□□□□□□□□□□
6. Write about unbalanced growth strategy L1
□□□□□□□□ □□□□□□ □□□□□□□□□□□ □□□□□□ □□□□□□□□□□
7. What are the objectives of planning? L1
□□□□□□□ □□□□□□□□□□ □□□□ ?
8. Write about NITI Aayog. L2
□□□□ □□□□□ □□□□□□ □□□□□□□□□□

Section-B

Answer the following questions

(5 x 10M = 50Marks)

9. a. What is Economic Development? How do you measure it? L3

After successful completion of this course, the student will be able to

1. Acquire knowledge of financial terms
2. Know the concepts relating to markets and different avenues of investment
3. Understand the career skills related to stock exchanges
4. Comprehend the personal financial planning and money market skills

UNIT –I INTRODUCTION

Structure of Indian Financial System and its components,
Financial markets and institutions

UNIT –II MONEY MARKET

Structure and Components of Money markets, Submarkets (Call money, Commercial Bills, Treasury Bills, Certificate of Deposits, Commercial Papers), Defects in Indian Money market

UNIT –III CAPITAL MARKET

Functions of Capital Market, Elements of Capital Markets (Shares, Debentures, Bonds, Mutual funds), Equity Market (Structures and Functions of SEBI), Secondary Market (BSE, NSE)

Textbook:

LM Bhole, Financial Markets, S.Chand and Company Publishers

Recommended Reference book:

- 1.T.R. Jain, R.L. Sarma, Indian Financial System, VK Global Publishers
- 2.Jithendra Gala – Guide to Indian Stock Markets Buzzing Stock Publishing House
- 3.Saha Siddhartha –Indian Financial System and Markets – Mc. Grawhill Publishers
- 4.Websites on Indian Financial Markets.

Course Delivery method : Face-to-face

Course has focus on :

Foundation

Websites of Interest :

1. <https://www.sebi.gov.in/>
2. <https://www.nseindia.com/>

Co-curricular Activities:

1. Collection and Study of pamphlets, Application forms etc.,
2. Invited Lectures on the field topics by local experts
3. Introducing online classes from NSE
4. Field visit to Mutual fund offices and share brokers
5. Observation, study and analysis of selected companies share prices
6. Assignments, Group Discussions, Quiz

MODEL QUESTION PAPER

SKILL DEVELOPMENT COURSE

**II B.A. (HEP) SEMESTER – III
FINANCIAL MARKETS**

Course Code (SDCECOT 01) w.e.f. 2021-2022

Time : 2 Hours

Max Makes 40

Section A

Answer any TWO of the following:

2x5=10M

1. What are the components of financial intermediaries?
2. Briefly explain the instruments of Money Market ?
3. Write about Bombay Stock Exchange (BSE)?

Section B

Answer any THREE of the following:

3x10=30M

4. Explain the role of financial markets in economic development
5. Explain the structure of Indian financial System
6. Write about the defects of Indian Money Market
7. Distinguish between Money Market and Capital Market
8. Explain the functions of SEBI

A.G & S.G Siddhartha Degree College of Arts and Science (Autonomous)

Vuyyuru - 521165

An autonomous college in the jurisdiction of Krishna university

III B.A (HEP), SEMESTER – V/VI

COURSE – VI(ECO-501C)

INSURANCE SERVICES

No of Hours per week : 5

Credits :4

- Co1 : Students are able to acquire the knowledge about principles of insurance since and functioning of insurance science
- Co2 : Students are about know importance of life insurance and products
- Co3 : Students are able to gain the knowledge about general and health insurance
- Co3 : Students are able to acquire the knowledge about practicing as an insurance agent
- Co5 : Students are able to acquire the knowledge about understanding the continuous midst and case studies related to the general or health

UNIT I : INSURANCE CONCEPT AND PRINCIPLES

Risk Management: Risk and Uncertainty, Risk Classification – Concept, Importance and Types of Insurance– Principles of Insurance – Insurance Regulations in India - Role of IRDA and Insurance Ombudsman –Scope for Insurance Business in India.

UNIT II : LIFE INSURANCE AND PRODUCTS

Life Insurance: Nature and Features - Major Life Insurance Companies in India - Important Life Insurance Products/policies and their Features: Conventional, Unit Linked, Annuities, Group Policies – Medical Examiner.

UNIT III : GENERAL AND HEALTH INSURANCES AND PRODUCTS

General Insurance: Nature, Features and Types - Major General Insurance Companies in India - Important General Insurance Products/Policies and their Features - Surveyor – Health Insurance: Nature and Features - Health Insurance Companies in India - Major Health Insurance Products/policies and their Features: Individual, Family, Group.

UNIT IV : PRACTICING AS AN INSURANCE AGENT

Insurance Contract and Terms of Insurance Policy - Registration of Insurance Agency with the Company - Procedure to issue a Policy: Application and Acceptance – Policy Lapse and Revival – Premium Payment, Assignment, Nomination and Surrender of Policy – Policy Claim - Important Websites and Apps of Insurance in India.

UNIT V : UNDERSTANDING THE CUSTOMER AND CASE STUDIES

Insurance Customer and Categories – Understanding Customer Mindset and Satisfaction - Addressing the Grievances of the Customer – Ethical Behavior in Insurance – Moral Hazard –Discussion of two different Case Studies related to Life or General or Health Insurance Services.

References:

1. Insurance Institute of India: Principles of Insurance (IC-01), Mumbai, 2011.
2. Insurance Institute of India: Practice of Life Insurance (IC-02), Mumbai, 2011.
3. Insurance Institute of India: Practice of General Insurance (IC-11), Mumbai, 2011
4. IGNOU: Life Insurance
<https://egyankosh.ac.in/bitstream/123456789/6472/1/Unit-20.pdf>
5. IGNOU: Non-Life Insurance
<https://egyankosh.ac.in/bitstream/123456789/6470/1/Unit-21.pdf>
6. P. Periyaswamy: Principles and Practice of Insurance, Himalaya Publishers, New Delhi (2nd Edition), 2019.
7. G. Dionne and S.E. Harrington (Eds.): Foundations of Insurance Economics, Kluwer Academic Publishers, Boston, 1997.
8. K. Jr. Black, and H.D. Skipper Jr.:Life and Health Insurance, Prentice Hall, Upper Saddle River, New Jersey, 2000.
9. <https://www.irdai.gov.in>
10. <https://www.insuranceinstituteofindia.com>
11. <https://licindia.in/>
12. Other Relevant web resources suggested by the teacher and college librarian

Co-Curricular Activities:

- a) Mandatory (Training of students in the related skills by the teacher for a total 10 Hours)

1) For Teacher: Training of students by teacher in the classroom and in the field for a total of not less than 10 hours on skills and hands on experience like explaining the details of an insurance policy to a customer – life, health and general policy, filling up application for a policy, calculation of premium and claim, make use of important websites and apps etc. pertaining to insurance and make a field visit to any insurance organization in local area. The expertise of practicing insurance agent or trainer can be utilized for this purposes.

A.G & S.G Siddhartha Degree College of Arts and Science (Autonomous)

Vuyyuru – 521165

An autonomous college in the jurisdiction of Krishna university

III B.A (HEP), SEMESTER – V

COURSE – VI ECO-501C /601C

MODEL QUESTION PAPER

INSURANCE SERVICES

Time : 3 Hours

Max. Marks : 70M

Min. Pass : 30 M

Section – A

Answer any TWO of the following.

2 x5= 10M

1. Types of Risk.
2. Benefits of Life Insurance.
- 3 Explain the types of general insurance
- 4.Grievance

Section – B

Answer Any FOUR of the following Questions

4 x15= 60M

- 5.Explain the difference between risk and uncertainty
- 6.Explain the scope for insurance business India
- 7.Explain the major health insurance policies/products/plans
- 8.Explain features of general insurances
- 9.Explain the process framing insurance contract
- 10.Explain the difference between assignment and nomination and in the insurance policy
11. What do you mean by customer satisfaction? Explain the importance of customer satisfaction
12. Explain the importance of ethical insurance

**A.G. & S.G.SIDDHARTHA DEGREE COLLEGE OF ARTS & SCIENCE
(AUTONOMOUS), VUYYURU (2021-2022)**

INSURANCE SERVICES

**The Guidelines to be followed by the question paper setters
in INSURANCE SERVICES for the 5th semester-end exams (2022 - 2023)**

PAPER TITLE :INSURANCE SERVICES

PAPER CODE ;ECO -501C

Course – VI Semester – V

Maximum marks : 70

Duaration;3Hours

Syllabus	Section-A (Short answer questions)	Section-B (essay questions)
Unit-1 (35Marks)	1	2
Unit-2 (5Marks)	1	----
Unit-3 (35Marks)	1	2
Unit-4 (30Marks)	---	2
Unit-5 (35Marks)	1	2
TOTAL =140	20	120

- Each short answer question carries 5 marks in Section-A
- Each Essay question carries 15 marks in Section –B

The Question papers setters are requested to cover all the topics in the syllabus stipulated as per the weightage given by US.

**A.G & S.G Siddhartha Degree College of Arts and Science (Autonomous)
Vuyyuru – 521165**

An autonomous college in the jurisdiction of Krishna university

III B.A (HEP), SEMESTER – V/VI

COURSE – VII ECO502C /602C

No of Hours per week : 5
Credits :4

BANKING AND FINANCIAL SERVICES

- Co1 : Students are able to acquire the knowledge about the principles of banking and Indian Banking system.
- Co2 : Students are able to acquire the knowledge about Deposits, Loans and Digital Banking Systems.
- Co3 : Students are able to acquire the knowledge about Banking correspondents and common service centers
- Co4 : Students are able to acquire the knowledge about Financial service of NBFIs.
- Co5 : Students are able to acquire the knowledge about more with Finance service Company (FSC).

UNIT I : PRINCIPLES OF BANKING AND INDIAN BANKING SYSTEM

Meaning of Banking – Principles of Banking – Functions of Banking – Structure of Indian Banking System – Regulations of Banking in India – Role of RBI in Banking – Anti-money Laundering - Basics of Financial literacy - Problems and Challenges of Banking in India.

UNIT II : DEPOSITS, LOANS AND DIGITAL BANKING

Bank Deposit Account Types – Account Opening and Closing – Banking Customer types – KYC Norms – Negotiable Instruments: Cheque, Bill of Exchange, Promissory Note, Endorsement - Principles of Lending – Different categories of Loans – Mortgaging -Priority Sector Lending – E-Banking facilities: Debit Card, Credit Card, Net Banking, Mobile Banking, Tele-banking, Micro ATMs, Digital Currency – Core Banking Solutions.

UNIT III : BANKING CORRESPONDENTS AND COMMON SERVICE CENTERS

Banking Correspondent Model - Activities of Banking Correspondent: Deposit Mobilization.

Identification of Borrowers, Collection and Recovery Loan, Other Banking Services – Common Services Centre (CSC) - Provision of Services by CSC – Requirement for Registering CSC and Telecentre - Case Study of Banking Correspondents with any Bank or CSC in Local Area.

UNIT IV : FINANCIAL SERVICES OF NBFIS

Non-Banking Financial Institutions (NBFIs): Types and Major Players of NBFIs in India – Important Financial Services offered by NBFIs and their Features – Concept of EMI - Micro Finance: Concept and Operation - Chit Funds: Concept and Operations– Payment Banks - Regulations of NBFIs in India – Problems and Challenges of NBFIs in India.

UNIT V : WORK WITH FINANCE SERVICE COMPANY (FSC)

Types of loans by Finance Service Company (FSC) – Customer of FSC: Types and Needs - Marketing of FSC's Loans – Procedures and Requirements in FSC's Loan Sanction - Collection and Recovery of FSC Loans - Case Study of a FSC's services in Local Area.

References:

1. Indian Institute of Banking and Finance: Principles and Practices of Banking, Macmillan India Limited, 2021.
<https://drive.google.com/file/d/1VU7aN4s5ikPQl7nX6mTBW-sVLQCNhfvK/view>
2. Indian Institute of Banking and Finance: Retail Banking, Macmillan India Limited, 2015.
3. D.R.Patade Babasaheb Sangale and T.N.Salve : Banking and Finance: Fundamental of Banking, Success Publications, Pune, January 2013.
<https://app1.unipune.ac.in/external/course-material/Fundamental-of-Banking-English.pdf>
4. N. Mukund Sharma: Banking and Financial Services, Himalaya Publishers, 2015.
5. Akhan Ali Jafor: Non-Banking Financial Companies in India: Functioning and Practice, New Century Publications, New Delhi, 2010.
6. RBI: “Non-Banking Financial Institutions” in Report on Trend and Progress of Banking in India 2019-20.

7. RBI: Discussion Paper on Engaging Business Correspondents.

https://www.rbi.org.in/scripts/bs_viewcontent.aspx?Id=2234

8. Govt. of India: Ministry of Electronic and Information Technology: Digital Seva-Operational Manual for Common Service Centres.

<https://csc.gov.in/assets/cscmanual/digitalsevaoperationalmanual.pdf>

9. <http://www.cscentrepneur.in/> for Telecentre Entrepreneurship Course

A.G & S.G Siddhartha Degree College of Arts and Science (Autonomous)
Vuyyuru – 521165

An autonomous college in the jurisdiction of Krishna university
III B.A (HEP), SEMESTER – V
COURSE – VII ECO502C
MODEL QUESTION PAPER

BANKING AND FINANCIAL SERVICES

Time : 3 Hours

Max. Marks : 70M

Min. Pass : 30 M

Section – A

Answer any TWO of the following.

2 x5=10M

- 1.KYC Norms
- 2.Loan recovery process
- 3.Operations of Micro finance institutions
- 4.Types of loan offered by finance services company

Section – B

Answer any FOUR of the following Questions.

4 x15= 60M

5. Define Bank? Explain the functions of banking
- 6.Explain the role of R.B.I in Indian banking system
- 7.Define the term negotiable instrument? Explain the features of negotiable instruments
- 8.Explain the advantages and disadvantages of digital currency
- 9.What is banking (Business) Correspondent model ? Explain the activities of it
- 10.Discuss about common services center(CSC)
- 11.Explain the Important financial services offered NBFI
- 12.Explain the Problems and Challenges of NBFIs in India

**A.G. & S.G.SIDDHARTHA DEGREE COLLEGE OF ARTS & SCIENCE
(AUTONOMOUS), VUYYURU (2021-2022)**

BANKING AND FINANCIAL SERVICES

The Guidelines to be followed by the question paper setters in BANKING AND FINANCIAL SERVICES for the 5th semester-end exams (2022 - 2023)

PAPER TITLE :BANKING AND FINANCIAL SERVICES

PAPER CODE ;ECO -502C

Course – VII Semester – V

Maximum marks : 70

Duaration;3Hours

Syllabus	Section-A (Short answer questions)	Section-B (essay questions)
Unit-1 (35Marks)	---	2
Unit-2 (5Marks)	1	2
Unit-3 (35Marks)	1	2
Unit-4 (30Marks)	1	2
Unit-5 (35Marks)	1	-----
TOTAL =140	20	120

- Each short answer question carries 5 marks in Section-A
- Each Essay question carries 15 marks in Section –B

The Question papers setters are requested to cover all the topics in the syllabus stipulated as per the weightage given by US.

THE END

**A.G&S.G SIDDHARTHA DEGREE COLLEGE OF ARTS AND SCIENCE
(AUTONOMOUS), VUYYURU**



DEPARTMENT OF ENGLISH

BOARD OF STUDIES MEETING

GENERAL ENGLISH

VENUE

ENGLISH LANGUAGE LABORATORY

DATE





22nd October, 2022

Minutes of the meeting of Board of Studies in General English for the Autonomous Courses of AG & SG Siddhartha Degree College of Arts & Science, Vuyyuru, held on 22-10 -2022 in the English Language Laboratory at 11:00 am.

Mr.B.Bulli Babu

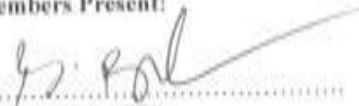
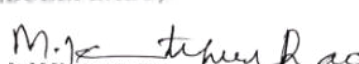
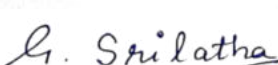
.. Presiding

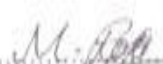
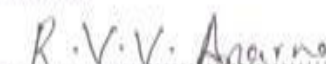
Members Present:

- 1) 
.....
(B.BULLI BABU) Chairman Head, Department of English
AG & SG S Degree College
Vuyyuru-521165
- 2) 
.....
(Dr.M.KOTESWARA RAO) University Nominee Professor,
Department of English
Krishna University,
Machilipatnam.
- 3) 
.....
(Dr.G.SRILATHA) Academic Council Nominee Head,
Department of English
P.B.S College, Vijayawada.
- 4) 
.....
(G.SONI) Academic Council Nominee Head,
Department of English
GDC, Ravulapalem
- 5) 
.....
(M.ROJA) Member Lecturer in English
A.G & S.G.S Degree College,
Vuyyuru-521165
- 6) 
.....
(R.V.V.APARNAY) Member Lecturer in English
A.G & S.G.S Degree College,
Vuyyuru-521165
- 7) 
.....
(ANEESA BEGUM) Member Lecturer in English
A.G & S.G.S Degree College,
Vuyyuru - 521165

**Agenda for B.O.S Meeting of General English for I & III SEMESTERS
for the Academic Year 2022-23**

The following proposals are submitted as a part of the agenda for the consideration and approval of the honorable members of Board of Studies, at the meeting held on 22nd October, 2022.

1. To recommend syllabi for 1st and 3rd semesters of I & II Degree students of all disciplines for the Academic Year 2022-23.
2. To Consider and approve the additional inputs and minor modifications if any, in the I & III Semester papers of General English.
3. To recommend the Model Question Papers of 1st and 3rd semesters of I & II Degree of all disciplines for the Academic Year 2022-23.
4. To recommend the Guidelines to be followed by the question paper setters in General English for the 1st and 3rd semester-end exams of I & II Year students of all disciplines.
5. To recommend the teaching and evaluation methods to be followed under Autonomous status.
6. To recommend topics for online teaching and evaluation patterns.
7. To consider and approve the implementation of Pedagogy methods like Quiz, classroom seminar, Assignment or Case study, Test, puzzles, viva and few more innovative methods in classroom teaching as indicated in the curricular plans.
8. To consider and approve to arrange Guest Lectures by Subject Experts @ 1(minimum) per Semester rounded up to more than 3 per academic year.
9. Any suggestions regarding Certificate/Add-on Courses, Seminars, Workshops, Guest Lectures and student competitions to be organized.
10. To note any changes in the syllabus if made by APSCH for the admitted batch of I Semester of the academic year 2022-23.
11. Any other matter.

RESOLUTIONS

1. Discussed and recommended the syllabus for 1st and 3rd semesters of I & II Degree students of all disciplines for the approval of the Academic Council.
2. Discussed and recommended the syllabi prescribed by APSCHE without any changes for 1st and 3rd semesters of I & II Degree students of all disciplines for the approval of the Academic Council.
3. Discussed and recommended the I & III Semester Model Question Papers of General English for the approval of the Academic Council.
4. Discussed and recommended the guidelines to be followed by the question paper setters of General English for 1st & 3rd Semesters of I & II year students of all disciplines for the approval of the Academic Council.
5. Discussed and recommended the teaching methodology to be taken up and the evaluation patterns to be done.

Teaching methods:

Besides the conventional methods of teaching (The Direct Method, The Structural Approach), Grammar-Translation Method, Audio-lingual Method, Communicative Language Teaching (CLT), Task-Based Language Learning etc., are practiced. We use modern technology i.e. using of an LCD projector, display on U boards, you tube videos etc., for better understanding of concepts.

There are two components in the Valuation and Assessment of a student – Internal Assessment (IA) and Semester Examinations (SE).

Internal Assessment (IA)

I SEMESTER

- The maximum mark for IA is 30 and SE is 70 for theory. Out of these 30 marks, 20 marks are allocated for announced tests.
- Each IA written examination is of 1 hour 30 minutes duration for 20 marks. The tests will be conducted centrally. The average of two such IA is calculated for 20 marks.
- Other Innovative Components will be for 5 Marks. The innovative component is for 5 marks, conducted during the class hours by the staff member/ in charge of the subject, in the form of assignments/ quiz/ seminars /presentations/Online/Open Book/Viva Voce/ Group work/ Mini Project/ Exhibition, etc. The topic and time for submission/ presentation will be announced by the staff member/ in charge of the subject in advance. Each student should explain and defend his/her presentation. For attendance 5 Marks are allotted.
- There is no passing minimum for IA.

Semester Examinations (SE)

- A student should register himself/herself to appear for the Semester Examinations by payment of the prescribed fee.
- The Semester Examinations will be in the form of a comprehensive examination covering the entire syllabus in each subject. It will be of 3 hours duration, with maximum 70 marks, irrespective of the number of credits allotted to it.

- Even though the candidate is absent for two IA exams/obtain zero marks, the external marks are considered (if he/she gets 40/70) and the result shall be declared as 'PASS'.
- The pass mark shall be 28 out of 70 in the Semester end examination.
- The maximum marks for each Paper shall be 100.

III SEMESTER

- The maximum mark for IA is 25 and SE is 75 for theory. Out of these 25 marks, 15 marks are allocated for announced tests.
- Each IA written examination is of 1 hour duration for 15 marks. The tests will be conducted centrally. The average of two such IA is calculated for 15 marks.
- Other Innovative Components will be for 5 Marks. The innovative component is for 5 marks, conducted during the class hours by the staff member/ in charge of the subject, in the form of assignments/ quiz/ seminars /presentations/Online/Open Book/Viva Voce/ Group work/ Mini Project/ Exhibition, etc. The topic and time for submission/ presentation will be announced by the staff member/ in charge of the subject in advance. Each student should explain and defend his/her presentation. For assignment 5 Marks are allotted.
- There is no passing minimum for IA.

Semester Examinations (SE)

- A student should register himself/herself to appear for the Semester Examinations by payment of the prescribed fee.
 - The Semester Examinations will be in the form of a comprehensive examination covering the entire syllabus in each subject. It will be of 3 hours duration, with maximum 75 marks, irrespective of the number of credits allotted to it.
 - Even though the candidate is absent for two IA exams/obtain zero marks, the external marks are considered (if he/she gets 40/75) and the result shall be declared as 'PASS'.
 - The pass mark shall be 30 out of 75 in the Semester end examination.
 - The maximum marks for each Paper shall be 100.
6. Discussed and recommended the topics for online teaching to be taught and the evaluation patterns to be taken up.
 7. Considered and approved the implementation of Pedagogy methods like Quiz, classroom seminar, Assignment or Case study, Test, puzzles, viva and few more innovative methods in classroom teaching as indicated in the curricular plans.
 8. Considered and approved to arrange Guest Lectures by Subject Experts rounded up to 3 per academic year.
 9. Discussed and recommended to organize Seminars, Guest lectures, Workshops to enhance the knowledge of students besides conducting Certificate Course in Competitive English. It has been suggested that the Bridge Course may be conducted for the I year students before the commencement of regular classes. All these recommendations are forwarded for the approval of the Academic Council.
 10. Discussed and recommended to implement the 100% of the new syllabus introduced / made by APSCHE for the admitted batch of the I Semester for the academic year 2022-23. All these recommendations are forwarded for the approval of the Academic Council.
 11. Nil.

Signatures of the BOS Members:

Dr. M. KOTESWARA RAO
(University Nominee)

Dr. G. SRI LATHA
(Academic Council Nominee)

Ms. G. SONI
(Academic Council Nominee)

M. ROJA
(Member)

R.V.V. APARNA
(Member)

MS. ANEESA BEGUM
(Member)

Chairman

**A.G & S.G SIDDHARTHA DEGREE COLLEGE OF ARTS AND SCIENCE,
VUYYURU – 521165**
(An Autonomous College in the Jurisdiction of Krishna University, Machilipatnam.)
Accredited with “A” Grade by NAAC, Bengaluru
Semester - I

ENGLISH PRAXIS COURSE-I
A COURSE IN COMMUNICATION AND SOFT SKILLS

Course Code	ENGT11B	Course Delivery Method	Class Room/ Blended Mode - Both
Credits	03	CIA Marks	30
No.of Lecture Hours / Week	4	Semester End Exam Marks	70
Total No.of Lecture Hours	60	Total Marks	100
Year of Introduction:	Year of Offering: 2022-23	Year of Revision: -----	Percentage of Revision: 0%
CLASS:	I YEAR DEGREE (ALL COURSES)		

Course objective:

The main objective of this course is to equip the learners with listening, speaking, reading, writing skills and also build up their ability to use Soft Skills in their professional and daily life effectively.

COURSE OUTCOMES:

At the end of the course, the learners will be able to:

- CO 1.** Gain more confidence in learning various kinds of listening techniques as well as create more effective strategies to improve one’s ability to listen and to understand people. **PO2**
- CO 2.** Improve their speaking ability in English both in terms of fluency and comprehensibility and practice in using English to perform preliminary communicative functions required for their everyday social and professional interactions with others. **PO3**
- CO 3.** Explore basic elements of grammar and test their abilities in concord, modals, tenses, articles, prepositions, question tags and transformation of sentences. **PO7**
- CO 4.** Develop their written expression of thought and discover opportunities to build connections within the areas of punctuations, spelling and paragraph writing. **PO2**
- CO 5.** Formulate problem solving skills, making appropriate and responsible decisions, improve their attitude, emotional intelligence, telephone etiquette and interpersonal skills. **PO1**

Academic Year 2022-23
Changes made in the syllabus
Semester-I General English

Course content suggested by APSCHE	Additions	Deletion
<p>UNIT-I Listening Skills</p> <ol style="list-style-type: none"> 1. Importance of Listening 2. Types of Listening 3. Barriers to Listening 4. Effective Listening <p>UNIT-II Speaking Skills</p> <ol style="list-style-type: none"> 1. Sounds of English: Vowels and Consonants 2. Word Accent 3. Intonation <p>UNIT – III Grammar</p> <ol style="list-style-type: none"> 1. Concord 2. Modals 3. Tenses (Present/Past/Future) 4. Articles 5. Prepositions 6. Question Tags 7. Sentence Transformation (Voice, Reported Speech & Degrees of Comparison) 8. Error Correction <p>UNIT-IV Writing</p> <ol style="list-style-type: none"> 1. Punctuation 2. Spelling 3. Paragraph Writing <p>UNIT-V Soft Skills</p> <ol style="list-style-type: none"> 1. SWOC 2. Attitude 3. Emotional Intelligence 4. Telephone Etiquette 5. Interpersonal Skills 	<p>Nil</p>	<p>Nil</p>

Learning Outcomes

By the end of the course the learner will be able to :

- Use grammar effectively in writing and speaking.
- Demonstrate the use of good vocabulary
- Demonstrate an understating of writing skills
- Acquire ability to use Soft Skills in professional and daily life.
- Confidently use the tools of communication skills

ENGLISH PRAXIS COURSE-I A COURSE IN COMMUNICATION AND SOFT SKILLS SYLLABUS

Unit	Learning Units	Lecture Hours
I	Listening Skills 1. Importance of Listening 2. Types of Listening 3. Barriers to Listening 4. Effective Listening	10
II	Speaking Skills 1. Sounds of English: Vowels and Consonants 2. Word Accent 3. Intonation	10
III	Grammar 1. Concord 2. Modals 3. Tenses (Present/Past/Future) 4. Articles 5. Prepositions 6. Question Tags 7. Sentence Transformation (Voice, Reported Speech & Degrees of Comparison) 8. Error Correction	15
IV	Writing 1. Punctuation 2. Spelling 3. Paragraph Writing	10
V	Soft Skills 1. SWOC 2. Attitude 3. Emotional Intelligence 4. Telephone Etiquette 5. Interpersonal Skills	15

REFERENCES:

1. English praxis-I—A Course in communication and soft skills by S.B.Fathima Mary, Vivanta publishers 2021
2. English praxis-I—A Course in communication and soft skills by Himalaya Publishing House 2021.

**A.G & S.G SIDDHARTHA DEGREE COLLEGE OF ARTS AND SCIENCE,
VUYYURU – 521165
(An Autonomous College in the Jurisdiction of Krishna University, Machilipatnam)
Accredited with “A” Grade by NAAC, Bengaluru**

ENGLISH	ENGT11B	2022-2023	B.A,B.Com & B.Sc
----------------	----------------	------------------	-----------------------------

Time: 3 hours

Max Marks: 70

**The Pattern of the Question Paper for Semester – I: ENGT11B
Semester - I**

SECTION – A

- I. Answer the following questions. 3 x 5 = 15M**
(6 Paragraph questions should be given from UNIT – I (Listening Skills), UNIT-II (Speaking Skills) & UNIT – IV (Writing))

SECTION – B

- II. Answer any FIVE of the following questions. 2 x 5 = 10M**
(4 Paragraph questions should be given from UNIT – I (Listening Skills) & UNIT-II (Speaking Skills))

SECTION – C 20 M

- III. Answer the following as directed. L3 20x1=20M**
- Insert the correct word given in brackets : (5 Sentences to be given) (5x1=5)
 - Select the modal form from the options that best completes the sentence. (5x1=5)
 - Fill in the following blanks with suitable verb forms given in brackets. (5x1=5)
 - Choose an appropriate article given in brackets to complete the sentences. (5x1=5)

SECTION – D

- VI. Answer the following as directed. L3 2x5=10M**
- 2 questions from punctuation and 3 questions from spelling to be given. (5 Marks)
 - 2 questions from Voice, 1 question from Speech 1 question from Degrees of Comparison and 1 question from Correction of Sentences to be given (5 Marks)

Section-E

- V. Answer the following questions. 3x5=15M**
(6 Paragraph questions to be given from Unit – V Soft Skills)

**A.G & S.G SIDDHARTHA DEGREE COLLEGE OF ARTS AND SCIENCE,
VUYYURU - 521165
(An Autonomous College in the Jurisdiction of Krishna University, Machilipatnam.)
Accredited with "A" Grade by NAAC, Bengaluru**

ENGLISH	ENGT11B	2022-2023	B.A,B.Com & B.Sc
----------------	----------------	------------------	-----------------------------

Time: 3 hours

Subject Code : ENGT11B

Max Mark: 70

Pass Marks: 28

**Semester – I
A COURSE IN COMMUNICATION AND SOFT SKILLS – I**

ENGLISH PRAXIS – I, SEMESTER - I

Section-A

I. Answer the following questions.

3x5=15M

1. (a) What are the different types of listening? Describe in brief each of them. L2

Or

(b) What are the main barriers of listening? Expand each in your own words. L2
2. (c) How many consonant sounds are there in English language? What are they? L1

Or

(d) How many vowel sounds are there in English language? What are they? L1
3. (e) What are the elements that are essential to effective paragraph writing? L2

Or

(f) Write a paragraph on your favourite hobby. L2

Section-B

II. Answer the following questions.

2x5=10M

4. (a) Describe the process of listening. L2

Or

(b) What are the differences between listening and hearing? L2
5. (c) How many types of Intonations are there in English? What are they? L1

Or

(d) What is discriminative listening? Explain in your own words. L2

Section-C

III. Answer the following as directed. L3 (20x1=20M)

- A. i. My sister or my brothers _____ (is / are) arriving by flight today. **5x1 =5**
ii. Cars and bikes ----- (is / are) my means of transportation.
iii. A number of people _____ (has / have) written in about this subject.

- iv. The students, who all belonged to the same neighbourhood _____(form / forms) a formidable cricket team.
- v. My dogs, along with my cat, _____ (is / are) chasing the ball.

- B.** i. Asha loves mangoes _____ we take some for her. (shall / might) **5x1 =5**
 ii. _____ I borrow your pen, please. (could / would)
 iii. They _____ play the drums as well as the guitar. (present ability)
 iv. The bus _____ (will / must) be coming any minute. (expectedness)
 v. She _____ (can, could) run fast. (to show ability)

- C** i. Raghu _____ (teach / teaches) art in a school in Mangalore. **5x1= 5**
 ii. I _____ (live) in Delhi since 1998.
 iii. He _____ (read) a novel now.
 iv. She _____ (complete) her home work just now.
 v. They _____ (go / goes) to school every day

- D.** i. Mary is _____ Australian, but her husband is _____ European. (a, an , the) **5x1 =5**
 ii. _____ Ganges is a holy river. (a, an , the)
 iii. His father is _____ university professor. (a, an , the)
 iv. He was proud ----- his work. (on, of)
 v. Seema sings well, -----? (don't she, doesn't she)

Section-D

IV. Answer the following as directed. L3 (2x5=10M)

- A.** i. John said I enjoyed the breakfast very much (punctuation marks) **5x1=5**
 ii. Run as fast as you can he shouted (punctuation marks)
 iii. Begining (correct the spelling)
 iv. Restaurent (correct the spelling)
 v. Parlament (correct the spelling)

- B.** i. My friend has completed the work. (change into passive voice) **5x1=5**
 ii. A beautiful picture was painted by Tony. (change into active voice)
 iii. Jameel said, “ I am going home tomorrow”. (change into Indirect speech)
 iv. The lotus is the most beautiful flower. (change into positive degree)
 v . I speak the Telugu. (correct the sentence)

Section-E

V. Answer the following questions. (3x5=15M)

6. (a) Explain how SWOC / T model can be used to analyze an Individual. **L2 1x5=5**

Or

- (b) What are the characteristics of Emotional Intelligence? Explain. **L2**

7. (c) What are the tips that will help you communicate better over the phone? L1 **1x5=5**

Or

(d) How do you develop the positive attitude? L1

8. (e) What is the importance Attitude? L2 **1x5=5**

Or

(f) What are the Interpersonal Skills? L2

**A.G & S.G SIDDHARTHA DEGREE COLLEGE OF ARTS AND SCIENCE,
VUYYURU – 521165**
(An Autonomous College in the Jurisdiction of Krishna University, Machilipatnam.)
Accredited with “A” Grade by NAAC, Bengaluru
Semester – III (CBCS)
ENGLISH PRAXIS COURSE-III

A COURSE IN CONVERSATIONAL SKILLS

Course Code	ENG T01A	Course Delivery Method	Class Room/ Blended Mode - Both
Credits	03	CIA Marks	25
No.of Lecture Hours / Week	4	Semester End Exam Marks	75
Total No.of Lecture Hours	60	Total Marks	100
Year of Introduction:	Year of Offering: 2022-23	Year of Revision: -----	Percentage of Revision: 0%
CLASS:	II YEAR DEGREE (ALL COURSES)		

COURSE OBJECTIVE:

The main objective of this course is to enrich student’s abilities to speak fluently, participate confidently in any social interaction, face any professional discourse, demonstrate critical thinking and enhance conversational skills by deservng the professional interviews.

COURSE OUTCOMES:

At the end of the course the learners will be able to:

- CO1.** Analyze interpret, appreciate and comprehend the specified text and the contexts in terms of their content, purpose and form. **PO1**
- CO2.** Comprehend effectively for a variety of professional and social settings, adapting other writer’s ideas as they explore and develop their own. **PO2**
- CO3.** Engage in simple, common and basic social and academic conversations, demonstrating the ability to open and close a conversation and to ask for clarification, information or assistance, as well as agreeing/disagreeing and giving examples. **PO3**
- CO4.** Convey their own interpretations by building dialogues and developing the learner’s performance level in spoken English through the activities. **PO4**
- CO5.** Acquaint the learner with the skills to debate, describe and role play. **PO5**

Academic Year 2022-23
Changes made in the syllabus
Semester-III General English

Course content suggested by APSCHE	Additions	Deletion
<p>UNIT-I Speech 1. Tryst with Destiny - Jawaharlal Nehru Skills 2. Greetings 3. Introductions</p> <p>UNIT-II Speech 1. Yes, We Can Barack Obama Interview 2. A Leader Should Know How to Manage Failure Dr.A.P.J.Abdul Kalam/India Knowledge at Wharton Skills 3. Requests</p> <p>UNIT-III Interview 1. Nelson Mandela's Interview With Larry King Skills 2. Asking and Giving Information 3. Agreeing and Disagreeing</p> <p>UNIT-IV Interview 1. JRD Tata's Interview With T.N.Ninan Skills 2. Dialogue Building 3. Giving Instructions/Directions</p> <p>UNIT-V Speech 1. You've Got to Find What You Love Steve Jobs Skills 2. Debates 3. Descriptions 4. Role Play</p>	<p>Nil</p>	<p>Nil</p>

Learning Outcomes

By the end of the course the learner will be able to :

- Speak fluently in English
- Participate confidently in any social interaction
- Face any professional discourse
- Demonstrate critical thinking
- Enhance conversational skills by observing the professional interviews

SYLLABUS

Unit	Learning Units	Lecture Hours
I	Speech 1. Tryst with Destiny - Jawaharlal Nehru Skills 2. Greetings 3. Introductions	10
II	Speech 1. Yes, We Can Barack Obama Interview 2. A Leader Should Know How to Manage Failure Dr.A.P.J.Abdul Kalam/India Knowledge at Wharton Skills 3. Requests	10
III	Interview 1. Nelson Mandela's Interview With Larry King Skills 2. Asking and Giving Information 3. Agreeing and Disagreeing	15
IV	Interview 1. JRD Tata's Interview With T.N.Ninan Skills 2. Dialogue Building 3. Giving Instructions/Directions	10
V	Speech 1. You've Got to Find What You Love Steve Jobs Skills 2. Debates 3. Descriptions 4. Role Play	15

REFERENCES:

1. ENGLISH PRAXIS III – A Course in Conversational Skills by S.B.Fatima Mary, VIVANTA PRESS -2021.
2. ENGLISH PRAXIS III – A Course in Conversational Skills by Himalaya Publishers – 2021.

**A.G & S.G SIDDHARTHA DEGREE COLLEGE OF ARTS AND SCIENCE, VUYYURU -
521165**

(An Autonomous College in the Jurisdiction of Krishna University, Machilipatnam.)

Accredited at 'A' Grade by NAAC

ENGLISH	ENG T01A	2022-2023	B.A,B.Com & B.Sc
----------------	-----------------	------------------	-----------------------------

The Pattern of the Question Paper for Semester – III: ENG T01A

Section - A

I. Answer any FIVE of the following questions. **5x5=25M**
(Any Six essay questions should be given from all speeches and interviews in the given syllabus)

Section – B

II. Answer any FIVE of the following questions. **5x2=10M**
(Any Six short answer questions should be given from all speeches and interviews in the given syllabus)

Section – C

- III. GREETINGS** **1x4=4 Marks**
(This question should be given from the prescribed text book, page no's 08-17)
- IV. INTRODUCTIONS** **1x4=4 Marks**
(This question should be given from the prescribed text book, page no's 17-26).
- V. V. REQUESTS** **1x4=4 Marks**
(This question should be given from the prescribed text book, page no's 40-46)
- VI. ASKING AND GIVING INFORMATION** **1x4=4 Marks**
(This question should be given from the prescribed text book, page no's 58-63)
(OR)
- VII. AGREEING DISAGREEING**
(This question should be given from the prescribed text book, page no's 63-72)
- VIII. DIALOGUE BUILDING** **1x4=4 Marks**
(This question should be given from the prescribed text book, page no's 78-85)
- IX. GIVING INSTRUCTIONS / DIRECTIONS** **1x4=4 Marks**
(This question should be given from the prescribed text book, page no's 86-97)
- X. DEBATES** **1x4=4 Marks**
(This question should be given from the prescribed text book, page no's 105-112)
- XI. DESCRIPTIONS** **1x4=4 Marks**
(This question should be given from the prescribed text book, page no's 113-120)
- XII. ROLE-PLAY** **1x3=3 Marks**
(This questions should be given from the prescribed text book, page no's 121-124)

**A.G & S.G SIDDHARTHA DEGREE COLLEGE OF ARTS AND SCIENCE, VUYYURU -
521165**

(An Autonomous College in the Jurisdiction of Krishna University, Machilipatnam.)

Accredited at 'A' Grade by NAAC

ENGLISH	ENG T01A	2022-2023	B.A,B.Com & B.Sc
----------------	-----------------	------------------	-----------------------------

Time: 3 hours

Max Mark: 75

Question Paper Model

SECTION-A

I. Answer any FIVE of the following questions. 5x6=30M

1. What was the pledge that Jawaharlal Nehru wanted every citizen of India to take?
CO 1 L2
2. What does Barack Obama in his speech say that change has come to America? CO4
L4
3. What are the challenges that the Americans are expected to face? CO1 L3
4. What are the six leadership traits that Kalam talks about? CO1 L2
5. Why did Nelson Mandela say that he never got angry? CO3 L2
6. What are the major changes in Indian business that were noticed by J.R.D.Tata? CO2
L4

SECTION-B

II. Answer any FIVE of the following questions. 5x2=10M

1. Why did Steve Jobs become interested in Calligraphy? CO4 L4
2. Who is Ann Nixon Cooper? What does Obama say about her? CO1 L1
3. How does Dr. A.P.J. Abdul Kalam describe his spirituality? CO3 L2
4. How does Tata describe Birla? CO3 L2
5. What does freedom and power bring? CO2 L4
6. What was the ambition of the greatest man of our generation? CO1 L4

SECTION-C (35 M)

III. Mr Krishna meets Ms Bhaskar, his son's teacher, at the school. Write a dialogue between them.

CO2. L2 1x4=4M

IV. Jagadish from Tiruamla Technologies, Tirupathi, goes to the office at Hyderabad to meet the Company's Finance Manager, on his prior appointment. Jagadish introduces himself to the Finance Manager's secretary, explaining who he is, where he is from, and why he is there. CO3. L1

1x4=4M

V. List any five debate points on Impact of Social Media on Youth. CO4. L4

1x4=4M

VI. Build up a conversation based on the hints given below.

Good morning – new to this place – in the Air Force – what do you do? – How fortunate! Need to enroll my daughter in a school – tell me about good schools in Vishakapatnam – thank you.

CO. L3

1x4=4M

- VII.** Rahul is a new student in the college. He asks Bharat for directions to the library. Give some directions. **CO3. L3** **1x4=4M**
- VIII.** Anu asks her friend Rajesh to get her college admission form from the college. Write a dialogue of request. **CO4. L2** **1x4=4M**
- IX.** Construct a dialogue between the customer and a shop keeper seeking information about the price of the groceries. **CO4. L1** **1x4=4M**
- X.** Your parents insist that you should cut down your extra-curricular activities in order to focus on your studies. Construct a dialogue either agreeing or disagreeing with your parent. **CO4. L1** **1x4=4M**
- XI.** Plan a role play between the principal and a parent asking him/her to take care of his/her child's attendance. **CO5. L2** **1x3=3M**

**A.G& S.G.SIDDHARTHA DEGREE COLLEGE OF ARTS &
SCIENCE**

VUYYURU-521165, KRISHNA Dt., A.P.(Autonomous)

Accredited by NAAC with "A" Grade

2022-2023



DEPARTMENT OF HINDI





MINUTES OF BOARD OF STUDIES

ODD SEMESTER

22-10-2022

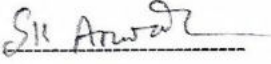
Minutes of the meeting of Board of Studies in Hindi for the Autonomous Courses of A.G & S.G Siddhartha Degree College of Arts & Science, Vuyyuru at 11.00AM on 22-10-2022 in the Department of Hindi.

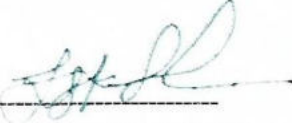
Members Present:

1. 
Sk. Anwar
Chairman
Head of the Department of Hindi
AG & SGS Degree College
Of Arts & Science, Vuyyuru.
2. 
Dr. V. Mohana Rao
University
Representative
Lecturer in Hindi, principal
KRK Govt Degree college.
Singarayakinda, Addanki
Prakashandistrict.
3. 
Dr. K. Srikrishna Nominee
Academic Council
Asst. Professor,
Department of Hindi,
Aacharya Nagarjuna University.
Guntur.
4. 
Smt. A. Ram Lakshmi
Academic Council
Asst. Professor,
Nominee Department of Hindi,
S. D.M siddharthamahilakalashala,
Vijayawada.
5. 
Dilshad Begum
Student's
Representative
Lecturer in Chemistry
AG & SGS Degree College of
Arts & Science, Vuyyuru

Agenda for BOS Meeting

1. To discuss about the syllabi, model question papers and guidelines of I and III semester of I & II degree in Hindi for the academic year 2022-2023.
2. To discuss about the change of question papers of I & III semester for the academic year 2022-23
3. Any other matter.

Resolutions

1. It is unanimously resolved that there is no change in the syllabi I & III semester of First And second degree in Hindi for the academic year 2022-23.

2. It is unanimously resolved that there is no change in the model question papers I & III semester of 1ST & 2ND degree in Hindi for the academic year 2022-23
3. It is unanimously resolved to follow the evaluation ratio 70:30(External and Internal) for the I & II degree for the academic year 2022-23
4. Nil.

S. K. Anand

HINDI	HINT11A	2022-23	B.A., B.Com., B.B.A., & B.Sc.
-------	---------	---------	-------------------------------

SEMESTER-I

Credits – 3

HINDI - I

COURSE OUTCOMES:

- CO1 - मानव मूल्यों को पहचानकर समाज कल्याण हेतु देने के लिए तैयार रहना ।
- CO2 - आधुनिक युग की भावनाओं को पहचानकर सामाजिक समस्याओं का सामना करते हुए, निरंतर आगे बढ़ना ।
- CO3 - विद्यार्थियों को शब्दावली से एक भाषा से दुसरे भाषा का अन्नवाद कर सकता है ।
- CO4 - छात्रों को इस व्याकरण के द्वारा भाषा में निपुणता आती हैं ।
- CO5 - छात्रों के इस पत्र-लेखन द्वारा लिखित कार्य बढ़ता है और संप्रेषण का विकास होता है ।

I. गद्य संदेश :

- 1. साहित्य की महत्ता
- 2. सच्ची वीरता
- 3. मित्रता

II. कथा - लेक :

- 1. मुक्तिधन
- 2. गूदड साई
- 3. उसने कहा था

III. व्याकरण : कार्यालयीन हिन्दी शब्दावली

(हिन्दी से अंग्रेजी में बदलना तथा अंग्रेजी से हिन्दी में बदलना)

IV. व्याकरण : लिंग, वचन, उल्टे शब्द, काल, वाच्य, वाक्य शुद्ध कीजिए

V. पत्र-लेखन : पत्र-लेखन (मित्र को पत्र, पिताजी को पत्र)

Recommended Books:

- 1. गद्य संदेश - Dr. V.L.Narasimham Siva Koti
- 2. कथा लेक - Dr. Ghana Shyam

Course Code: **HINT11A**

(Hindi-I)

Max. Marks: 75M

Time: 3 Hrs.

Pass Min. : 30M

~~~~~

**PART-A**

**निम्न लिखित प्रश्नों में से किन्हीं पाँच प्रश्नों का उत्तर दीजिए :**

**5 X 5 = 25M**

1. साहित्य की जीवन में क्या आवश्यकता हैं ? साहित्य द्वारा सभ्यता की परीक्षा किस प्रकार हो सकती हैं ?
2. वीरता किसे कहते हैं सच्ची वीरता तथा झूठी वीरता का क्या अंतर हैं ?
3. भारतीय इतिहास में आदर्श मित्रता के कुछ उदाहरण दीजिए ?
4. मुक्तिधन कहानी की विशेषताएँ बताइए ?
5. गूदड़ साई कहानी का उद्देश्य क्या है ?
6. नीचे दिए गए शब्दों का वचन बदलिए ।  
(i) लडकी (ii) वीर (iii) सेना (iv) रुपया (v) कविता
7. काल किसे कहते हैं तथा उसके कितने प्रकार हैं ?
8. नीचे दिए गए शब्दों का लिंग बदलिए ।  
(i) विद्वान (ii) अध्यापक (iii) मोर (iv) ठाकुर (v) धोबी

**PART-B**

**निम्न लिखित प्रश्नों का उत्तर दीजिए :**

**5 X 10 = 50M**

9. (अ) साहित्य की महत्ता पाठ का सारांश लिखिए ।  
अथवा  
(आ) सच्ची वीरता पाठ का सारांश लिखिए ।
10. (अ) मुक्तिधन कहानी का सारांश लिखिए ।  
अथवा  
(आ) गूदड़ साई कहानी का सारांश लिखिए ।
11. (अ) किन्हीं पाँच शब्दों को अंग्रेजी से हिन्दी में अनुवाद कीजिए ।  
(i) Acceptance (ii) Ballot Officer (iii) Chairman (iv) Duty  
(v) Supervisor (vi) High Court (vii) Fair Copy (viii) Eligibility  
(ix) Passport (x) Accountant  
अथवा  
(आ) वाच्य किसे कहते हैं तथा वाच्य के प्रकारों के बारे में स्पष्ट कीजिए ।



12. (अ) किन्हीं पाँच शब्दों का उल्टे शब्द लिखिए ।

- (i) वीरता      (ii) अच्छा      (iii) नया      (iv) आना  
(v) दिन      (vi) सस्ता      (vii) मित्र      (viii) लेना

अथवा

(आ) वाक्य शुद्ध कीजिए ।

- (i) मोहन पुस्कत पढ़ा ।  
(ii) सीता ने चार आम खाया ।  
(iii) राम ने गया ।  
(iv) दशरथ की तीन रानियाँ थी ।  
(v) चोरी कौन किया ?

13. (अ) हिन्दी सीखने की आवश्यकता बताते हुए अपने मित्र को एक पत्र लिखिए ।

अथवा

(आ) पैसे माँगते हुए अपने पिताजी को एक पत्र लिखिए ।



|       |         |          |                               |
|-------|---------|----------|-------------------------------|
| HINDI | HINT01A | 2022-'23 | B.A., B.Com., B.B.A., & B.Sc. |
|-------|---------|----------|-------------------------------|

SEMESTER-III/IV

Credits – 3

HINDI - III

COURSE OUTCOMES:

- CO1 - दोहों के द्वारा विध्यार्थियों में समाज सुधारता, मानव मूल्य बढ़ते हैं ।  
CO2 - हिन्दी साहित्य का इतिहास के द्वारा हिन्दी भाषा की प्रामुख्यता और कविताओं की प्रामुख्यता मिल जाती हैं ।  
CO3 - समाज कल्याण विषयों को समझकर अपना ज्ञान बढ़ाते हैं ।  
CO4 - समाज में भाषा पर प्रामुख्यत, भाषा में ज्ञान प्राप्त करके, दूसरों से आसानी से संप्रोषित करना सीखेंगे ।  
CO5 - सरकारी व्यवस्थाओं को लेख लिखना, भाषा की विशेषता, समाज में सरकारी भाषा सीखकर दूसरों को आदर्शवान बन सकेंगे ।

I. काव्य दीप :

- कबीरदास - साखी - 1-10,  
सूरदास - बालवर्णन,  
मानु भूमि - मैथिलीशरण गुप्त,  
तोडती पत्थर - सूर्यकांत त्रिपाठी निराला  
गीत फरोश - भवानी प्रसाद मिश्र

II. हिन्दी साहित्य का इतिहास :

- काल विभाजन-आचार्य रामचन्द्र शुक्ल जी के अनुसार,  
भक्ति काल: ज्ञानाश्रयी शाखा - कबीर,  
प्रेमाश्रयी शाखा - जायसी

III. साधारण निबन्ध : समाचार पत्र, पर्यावरण और प्रदूषण, बैकारी की समस्या, कंप्यूटर

IV. अनुवाद : अनुवाद अभ्यास

V. प्रयोजनमूलक हिन्दी : परिपत्र, कार्यालय ज्ञापन, राष्ट्रभाषा हिन्दी

Recommended Books:

1. गद्य संदेश - Dr. V.L.Narasimham Siva Koti
2. कथा लेक - Dr. Ghana Shyam

Course Code: **HINT01A**

Max. Marks: 75M

Time: 3 Hrs.

Pass Min. : 30M

~~~~~

PART-A

निम्न लिखित प्रश्नों में से किन्हीं पाँच प्रश्नों का उत्तर दीजिए :

5 X 5 = 25M

1. व्याख्या कीजिए ।
पाहन पूजे हरि मिलै, तो मैं पूजूँ पहाड़ ।
ताते ये चाकी भली, पीस खाय संसार ॥
2. किसी एक कवि का साहित्यिक परिचय दीजिए ।
(i) कबीर (ii) सूर्यकांत त्रिपाठा निराला
3. मातृभूमि कविता की विशेषताएँ लिखिए ।
4. व्याख्य कीजिए ।
जी गीत जनम का लिखूँ, मरन का लिखूँ,
जी गीत जीत का लिखूँ, शरण का लिखूँ ।
5. ज्ञानमार्ग शाखा की विशेषताएँ बताइए ।
6. प्रदूषण के निवारणोपाय लिखिए ।
7. परिपत्र की परिभाषा दीजिए ।
8. अनुवाद किसे है ।

PART-B

निम्न लिखित प्रश्नों का उत्तर दीजिए :

5 X 10 = 50M

9. किसी एक कविता का सारांश विशेषताओं सहित लिखिए ।
(i) गीत फरोश (ii) तोड़ती पत्थर
10. (अ) हिन्दी साहित्य का इतिहास-काल विभाजन के बारे में लिखिए ।
अथवा
(आ) प्रेमाश्रय शाखा की विशेषताओं का परिचय दीजिए ।
11. किसी एक निबंध पर प्रकाश डालिए ।
(i) बेकारी की समस्या (ii) पर्यावरण और प्रदूषण (iii) कंप्यूटर

12. (अ) हिन्दी में अनुवाद कीजिए ।

5 X 2 = 10M

- (i) India is our country
- (ii) We should respect our parents
- (iii) How many students are there in the class room?
- (iv) Where are you going now?
- (v) This is our college.

अथवा

(आ) अंग्रेजी में अनुवाद कीजिए ।

- (i) हम कॉलेज जाते हैं ।
- (ii) हिन्दी हमारी राष्ट्रभाषा है ।
- (iii) रमा नाचती है ।
- (iv) मानव सेवा ही माधव सेवा है ।
- (v) कल रविवार था ।

13. किसी एक पर टिप्पणि लिखिए ।

- (i) परिपत्र
- (ii) कार्यालय ज्ञापन
- (iii) राष्ट्र-भाषा हिन्दी



**A.G& S.G.SIDDHARTHA DEGREE COLLEGE OF ARTS &
SCIENCE**

VUYYURU-521165, KRISHNA Dt., A.P.(Autonomous)

Accredited by NAAC with "A" Grade

2022-2023



DEPARTMENT OF HISTORY

MINUTES OF BOARD OF STUDIES

ODD SEMESTER

26-10-2022

AGENDA

1. To Review and recommend any changes in the syllabi , Model Question Papers and Guidelines of 1st, 3rd and 5th Semesters of I, II and III Year B.A History Papers for the Academic Year 2022 - 2023.
2. To Discuss and recommend the pattern of internal Assessment , Guidelines and Model Question Papers in 1st, 3rdand 5th Semesters of B.A Degree History papers for the Academic Year 2022-2023.
3. To Recommend the guidelines to be followed by the Question Paper Setters in History for the 1st, 3rd and 5th Semester-end exams.
4. To Recommend the teaching and evaluation methods to be followed under the Autonomous Status.
5. To Propose the panel of Question paper setters and Examiners.
6. To Suggest innovative methods of teaching.
7. Any other matter.

RESOLUTIONS:

- 1) It is resolved to continue the same syllabi under CBC System approved by the Academic council of 2020- 2021 for I and III Semesters of I and II B,A Papers in the I and III Semesters of I and II B.A classes.

The APSHE was introduced Two New Subjects and New syllabus in the V Semester of III Degree B.A from the Academic year 2022 – 2023.

- 2) Out of maximum 100 marks in each paper 30 marks shall be allocated for Internal Assessments regarding I and V Semesters.

A) To implement 30 marks for internal assessment and 70 marks for External Assessment from the academic year 2019-20 and that is also implemented to the I and V Semesters from 2020-21 Academic year 2021 – 2022 Academic year and 2022 – 2023 Academic year also.

B) Out of these 30 marks, 20 marks are allocated for internal tests, 5 marks are allocated for assignment for I and V Semesters. The two tests will be conducted and average of these two tests shall be deemed as the marks obtained by a student, and remaining 5 marks are allocated for attendance.

3) Out of maximum 100 marks 25 Marks shall be allocated for Internal Assessments

Regarding the III Semester from the Academic year 2022 – 2023.

A) To implement 25 Marks for Internal Assessments and 75 Marks for External Assessment regarding the III Semester from the Academic year 2022 – 2023.

B) Out of these 25 marks, 15 Marks are allocated for internal tests, 5 marks are Allocated for assignment and 5 Marks for activity Regarding the III Semester from the Academic year 2022 – 2023.

- 4) Discussed and recommended the syllabi, Model question papers under CBC system and guidelines to be followed by the question paper setters of I,III and V semesters of B.A Classes for the Academic year 2022-2023.

5) To follow the teaching and evaluation methods, it is also resolved to use various other methods like Group discussions, Quiz, Organizing Seminars, Guest Lectures and Workshops to upgrade the knowledge of the students and impart new skills of learning as frequently as possible.

Resolved to authorize the chairman of Board of studies to suggest the panel of paper setters and Examiners to the controller of Examinations as for the requirement.

- 6) **The APSHE was introduced Two New choice Subjects i.e Tourism and Hospitality Services and Tourism Guidance and Operating Skills in the V Semester of III Degree B.A from the Academic year 2022 – 2023. It is resolved to Follow the APSCHE New syllabus in the V Semester of III Degree B.A from the Academic year 2022 – 2023.**

It is resolved to follow further changes if any in the syllabus by the competent Authority.

T. Narasimha R.
Chairman

AG & SG SIDDHARTHA DEGREE COLLEGE OF ARTS & SCIENCE VUYURU**A.P- 521165**

(An autonomous college in the jurisdiction of Krishna university, Machilipatnam)

PROGRAMME: B.A**STRUCTURE OF HISTORY SYLLABUS UNDER CBCS FOR 3-YEAR B.A.
PROGRAMME**

YEAR	CODE	SEM	Name of course <i>(each course consists 5 units with each unit having 12 hours of class work)</i>	Hours/week	Credits	Marks	
						Internal	Sem end
I		I	Ancient Indian history and culture (From Indus valley Civil to 13 century(A.D))	5	4	30	70
II		III	Modern Indian history and culture(1764-1947 A.D)	5	4	25	75
III		V	Tourism and Hospitality Services	5	4	30	70
		V	Tourism Guidance and Operating Skills	5	4	30	70

AG & SG SIDDHARTHA DEGREE COLLEGE OF ARTS & SCIENCE VUYURU

A.P- 521165

(An autonomous college in the jurisdiction of Krishna university, Machilipatnam)

HISTORY		2022-23	B.A/HEP
----------------	--	----------------	----------------

SEMESTER-1

Course -1
No. of Credits: 4

(ANCIENT INDIAN HISTORY & CULTURE FROM INDUS VALLEY CIVILIZATION TO 13TH CENTURY A. D) (NEW SYLLABUS)

Learning objectives:

1. To Identify the various kinds of sources and various stages of Indian civilization and religions like Buddhism and Jainism
2. To impart knowledge about religions like Buddhism and Jainism and Mouryan empire.
3. Inculcating awareness on ancient kingdoms of south Indian rulers.
4. Enlighten them with great Indian rulers like Gupta 's and Harshvardhan.
5. To provide the knowledge about the Cholas and Kakatiyas

Course Outcomes:

1. It encourages students to think explicitly about the aims of Indian history and culture
2. Acquire knowledge of Indian religions such Buddhism and Jainism. Acquainted with Indian kingship and culture -Mouryas and Satavahanas
3. Evaluate the south Indian administration and cultural contribution of Pallavas.
4. Ancient knowledge of golden age Guptas and cultural contribution oh Harsha.
5. Evaluate the administration of Cholas and greatness of Kakatiyas.

Unit - 1

12 hrs

1.1-Ancient Indian Civilization (from Circa 3000 BC to 6th BC):

1.2 Indus Valley Civilization - Salient Features

1.3 Vedic Age - Society, Polity, Economy, Culture during early and later Vedic period

Unit - II

12 hrs

2.1- Ancient Indian History & Culture (6th Century BC to 2nd Century AD):

2.2- Doctrines and Impact of Jainism and Buddhism;

2.3- Mauryan Administration, Society, Economy & Culture - Ashoka's Dharma;

2.4- Kanishka's Contribution to Indian Culture

Unit - III

12 hrs

3.1-History & Culture of South India (2nd Century BC to 8th Century AD):

3.2 Sangam Literature; Administration, Society, Economy and Culture under Satavahanas

3.3 Cultural contribution of Pallavas

Unit - IV

12 hrs

4.1- India from 3rd century AD to 8th century AD: Administration, Society, Economy, Religion, Art, Literature and Science & Technology under Guptas - Samudragupta.

- 4.2- Cultural contribution of Harsha:
- 4.3 Arab Conquest of Sind and its Impact

Unit - V

12 hrs

- 5.1-History and Culture of South India (9th century AD to 13th century AD):
- 5.2 Local Self Government of Cholas
- 5.3 Administration, Society, Economy and Culture under Kakatiyas – Rudramma Devi

CO-CURRICULAR ACTIVITIES AND ASSESSMENT METHODS:

Continuous Evaluation:

1. Monitoring the students progress of learning by Class Tests.
2. Map pointing
3. Projects, Assignments and Group Discussions, Enhances critical thinking skills and Personality.
4. Semester-End Examination: Critical indicator of students learning and teaching methods adopted by teachers throughout the semester

TEXT BOOKS:

1. Prachina Bhasha DesaCharitra – Si.K. Krishna Reddy.
2. BharathaDesaCharitra – Telugu Academy

REFERENCES:

1. A.L. Basham, The Wonder That Was India
2. D.N.Jha, Ancient India
3. D.D.Kosambi, An Introduction to the Study of Indian History
4. D.P.Chattopadhyay, Science and Society in Ancient India
5. B.N.Mukherjee, The Rise and Fall of the Kushana Empire
6. K.A. NilakanthaShastri, A History of South India
7. R.C.Majumdar, K.K.Dutta&H.C.RoyChowdhuri (ed.), Advanced History of India
8. Kumkum Roy, The Emergence of Monarchy in North India: eighth to fourth centuries BC
9. RomilaThapar (et. al). India: Historical Beginnings and the Concept of the Aryan
10. M.L.K. Murthy, Pre-and Protohistoric Andhra Pradesh upto 500 B.C., New Delhi, 2003 11 K. Sathyanarayana, A Study of the History and Culture of Andhras

AG & SG SIDDHARTHA DEGREE COLLEGE OF ARTS & SCIENCE VUYYURU

A.P- 521165

(An autonomous college in the jurisdiction of Krishna university, Machilipatnam
**(ANCIENT INDIAN HISTORY & CULTURE FROM INDUS VALLEY CIVILIZATION TO
13TH CENTURY A. D)**

HISTORY Model Question Paper
(NEW MODEL PAPER)
B.A/ HEP – SEMESTER - I

Time : 3 hrs

Max. Marks : 70

PART – A

Answers All Questions :All Questions Carry Equal Marks
(Restrict a Maximum of 2 Sub-Division)

14x5=70

1.A)Explain about the Indus Valley Civilization. Co1 L2 (10M)

OR

B)What are the main features of Vedic civilization Co1 L1 (10M)

2. A)Explain the Archeological Sources Co1 L2 (4M)

OR

B). Explain Mahavira and his teachings Co1 L2 (4M)

3. A)Explain Early life and teachings of Buddha. Co2 L2 (10M)

OR

B)Examine about Mauryan administration Co2 L3 (10M)

4.A).Analyse Ashoka's contributions to Buddhism Co2 L3 (4M)

OR

B)Explain the role of kanishka.Co2 L2 (4M)

5.A)Explain the general conditions of Satavahanna's. Co3 L2 (10M)

OR

B).Define the cultural contribution of pallava's Co3 L1 (10M)

6.A)What are the main aspects of sangam age Co3 L1 (4M)

OR

B)Estimate the invasions of SamudraGuptaCo4 L4 (4M)

7. A)Illustrate the Golden age of Gupta's Co4 L2 (10M)

OR

B)Define the role of harshavardhana in Indian History Co4 L1 (10M)

8 A)..Analyse Arab invasions. Co4 L3 (4M)

OR

B)Estimate the role of Raja raja chola Co5 L4 (4M)

9. A)Explain Chola's administration Co5 L2) (10M)

OR

B).Examine the administration Of Kakatiyas Co5 L3 (10M)

10A)Gauthamiputrasatakarni (4M)

OR

B)Rudramadevi (4M)

AG & SG SIDDHARTHA DEGREE COLLEGE OF ARTS & SCIENCE VUYURU

A.P- 521165

(An autonomous college in the jurisdiction of Krishna university, Machilipatnam)

HISTORY		2022-23	B.A/HEP
----------------	--	----------------	----------------

SEMESTER - III

Course- III

No. of Credits: 4

MODERN INDIAN HISTORY & CULTURE (1764-1947 A. D) **(NEW SYLLABUS)**

Learning objectives:

1. To impart the knowledge about British rule, policies and 1857 revolt.
2. To enlighten the students about the socio-religious movements
3. To inspire students by freedom struggle.
4. To make understand the role of Gandhiji and Subhash Chandra Bose in freedom movement
5. To give right knowledge about the Partition of India and integration of princely states.

Course Outcomes:

1. Acquired the knowledge of British rule and 1857 revolt
2. Learnt about the social and religious system of India
3. Gained the knowledge about freedom struggle
4. Inspired by the National leaders like gandhiji and their ideologies
5. Thoroughly learned about partition of india and integration of princely states

Unit - 1

12 hrs

1.1-Policies of Expansion -Warren Hastings, Cornwallis - Subsidiary Alliance & Doctrine Of Lapse Causes & Results of 1857 Revolt - Lytton, Rippon, Curzon

Unit - II

12 hrs

2.1- Social, Religious & Self-Respect Movements - Raja Rammohan Roy,
2.2 - DayanandaSaraswathi, Swami Vivekananda, JyotibaPhule, Narayana Guru, Periyar, Dr. B. R. Ambedkar

Unit -III 12 hrs

3.1- Causes for the growth of Nationalism - Freedom Struggle from 1885 to 1920:
3.2 - III Moderate Phase - Militant Phase: Vandemataram Movement - Home Rule Movement

Unit - IV

12 hrs

4.1. Freedom Struggle from 1920 to 1947: Gandhiji's Role in the National Movement - Revolutionary Movement - Subash Chandra Bose

Unit - V

12 hrs

Muslim League & the Growth of Communalism - Partition of India - Advent of Freedom - Integration of Princely States into Indian Union - SardarVallabhai Patel

Co-curricular activities and Assessments Methods:

Continuous Evaluation:

1. Monitoring the progress of student's learning, Class Tests
2. Map pointing
3. Projects, Assignments and Group Discussions, Enhances critical thinking skills and Personality.
4. Semester-end Examination: Critical indicator of students learning and teaching methods adopted by teachers throughout the semester

TEXT BOOKS:

1. Bhasha DesaCharitra - Madhya yugam- Si.K. Krishna Reddy.
2. BharathaDesaCharitra - Telugu Academy

References:

- 1 Anil Seal, Emergence of Indian Nationalism
- 2 Banerjee, Sekhar, From Plassey to Partition
- 3 Bipan Chandra, Rise and Growth of Economic Nationalism in India

AG & SG SIDDHARTHA DEGREE COLLEGE OF ARTS & SCIENCE VUYURU

A.P- 521165

(An autonomous college in the jurisdiction of Krishna university, Machilipatnam)

MODERN INDIAN HISTORY & CULTURE (1764-1947 A. D)

MODEL PAPER

HISTORY Model Question Paper
(NEW MODEL PAPER)
B.A/ HEP –SEMESTER -III

Time : 3 hrs

Max. Marks : 75

PART– A

I) Answer any FIVE of the following : 5 x 5=25M
(one Questions to be set from each unit)

1. Explain the reforms of Warren Hastings. Co1 L2
2. How far Lord Dalhousie was responsible for the 1857 revolt. Co1 L1
3. Analyse the contributions of Dr. B. R. Ambedkar. Co2 L3
4. Define Theosophical society and its contributions. Co2 L1
5. What is the role of moderates in freedom movement Co3 L1
6. Explain the role of Bhagat Singh Co4 L2
7. What is Lucknow Pact Co5 L1.
8. Examine role of Muslim League Co5 L3

PART – B

II. Answer any FIVE of the following:
50M

5 x 10=

(one Questions to be set from each unit)

- 1 A) What are the causes for the outbreak of 1857 revolt. Co1 L1

OR

- b.) Explain Lord Rippon's reforms Co1 L2
2.A) Explain the role of Raja Ram Mohan Ray Co2 L2

OR

- b.) How did social reform movements play a role in the freedom struggle Co2 L1

- 3A) What are the causes for the rise of nationalism Co3 L1

OR

- b.) What is the role of extremists in the freedom movement Co3 L1

- 4A) What was the role of Mahatma Gandhi in the freedom struggle Co4 L1

OR

- b.) Explain the role of Subhash Chandra Bose Co4 L2

- 5A) What are the causes for the growth of communalism and the partition of India Co5 L1

OR

b.)What role did sardar vallabhaipatel played in the integration of princely states Co5 L1

AG & SG SIDDHARTHA DEGREE COLLEGE OF ARTS & SCIENCE VUYYURU

A.P- 521165

(An autonomous college in the jurisdiction of Krishna university, Machilipatnam)

(2021 – 2022)

III BA History Syllabus:: Semester – V (CBCS) Paper – V

Title of the Paper : **TOURISM AND HOSPITALITY SERVICES 6B**

Paper Code; SECHIS601

No.of Hours per week:5

No. of Credits:4

I. Learning Outcomes:

Students after successful completion of the course will be able to:

1. Understand hospitality as a career
2. Inculcate interpersonal skills
3. Develop the ability for multitasking and crisis management
4. Understands the spirit of teamwork
5. Acknowledge the importance of guest service and satisfaction

Unit: 1

Tourism – Definition – Nature and Scope – History of Tourism–Types of Tourism – Domestic and International Tourism – Causes of rapid growth of tourism – National Institute of Tourism and Hospitality Management

Unit: 2

Relationship between history and tourism - Major tourist spots in AP – Gandikota, Nagarjunakonda, Salihundam, Konaseema

Unit: 3

Characteristics of Hospitality Industry - Inflexibility, Intangibility, Perish ability- Types of Hospitality jobs – Hotel Manager, Hotel Receptionist, Restaurant Manager, Catering Assistant, Executive Chef etc - Concepts of Atithi Devo Bhavah - Types of hotels in India

Unit: 4

Duties, responsibilities & skills of front office staff – duties, responsibilities and skills of housekeeping staff - guest stay process in a hotel - major processes and stages associated with it

Unit: 5

Different types of services offered in selected Hotels/Motels/Restaurants - Room Service, Catering Services -Different types of managerial issues - Service etiquettes

III. References:

1. Marketing for Tourism and Hospitality, Philip Kotler, Bowen and James Makens, Pearson Pub, New Delhi, 2010
2. Soft Skills for Hospitality, Amitabh Devendra, Oxford Higher Edn, 2015
3. The Indian Hospitality Industry: Dynamics and Future Trends, Ed: Sandeep Munjal, Sudhanshu Bhushan, CRC Press, 2017
4. Hotel Front Office: Operation and Management, Jatashankar Tewari, Oxford Higher Edn, 2016

5. www.ilo.org
6. <https://riginstitute.com>
7. nitahm.ac.in
8. web sources as suggested by teacher/librarian

IV. Co-Curricular Activities:

a) Mandatory:

(Training of student in skills by Teacher: Total 10 Hours)

1) For Teacher: Training of students by the teacher in the classroom and in the field for a total of

not less than 10 hours on various practical aspects related to tourism and hospitality industry. The

teacher shall also train students with the help of experts in skills such as flower arrangements, cooking and catering supervision, speaking to guests etc. related to hospitality services.

2) For Student: Students shall visit any one of the local tourism offices, tourism sites, hotels, restaurants, catering offices to make personal observations and to gain hands-on experience. These individual observations shall be written as a Fieldwork/Project work Report not exceeding

10 pages and submit to teacher in the given format.

3) Suggested Fieldwork/Project work Format:

Title Page, Student Details, Acknowledgments, Index of Contents: Objectives, Step-wise process, Findings & References

4) Max Marks for Fieldwork/Project work Report: 05

5) Unit Tests/Internal Examinations

b) Suggested Co-Curricular Activities

- 1) Invited Lectures
- 2) Hands on Experience with the help of Field Experts.
- 3) Debates on Interesting Topics
- 4) Seminars, Group Discussions, Quiz, etc.
- 5) Assignments
- 6) Alumni Interactions
- 7) Periodical Interactions with HR Managers

AG & SG SIDDHARTHA DEGREE COLLEGE OF ARTS & SCIENCE VUYURU

A.P- 521165

(An autonomous college in the jurisdiction of Krishna university, Machilipatnam)

Model Question Paper

HISTORY Model Question Paper
(NEW MODEL PAPER)
B.A/ HEP – SEMESTER – V/VI

Time : 3 hrs

Max. Marks : 70

Title: Tourism and Hospitality services

paper code; 3HIS6B

Section-A

I.ANSWER ANY TWO OF THE FOLLOWING QUESTIONS 2x5=10

- 1 Explain the causes of rapid growth of tourism?**
- 2 Types of restaurants services?**
- 3 Konasema ?**
- 4 Atithi devo bhava ?**

Section - B

II. Answer any four of the following questions

4x15=60

- 5. Define tourism write about nature and scop of tourism?**
- 6. Discuss about different types of services offered in a selected hotels?**
- 7. Major tourism spots in Andhra Pradesh?**
- 8. Write about domestic tourism and international tourism?**
- 9. Explain duties and responsibilities of house keeping staff?**
- 10. Explain different types of hotels in india ?**
- 11. Discuss about hospitality industry?**
- 12. Explain the relationship between history and tourism?**

AG & SG SIDDHARTHA DEGREE COLLEGE OF ARTS & SCIENCE VUYYURU

A.P- 521165

(An autonomous college in the jurisdiction of Krishna university, Machilipatnam)

Title: Tourism and Hospitality services

paper code; 3HIS6B

Section	Unit – I	Unit – II	Unit – III	Unit - IV	Unit-V
A 5 Marks Questions	1	1	1		1
B 15 Marks Questions	2	2	2	1	1
Weightage	35	35	35	15	20

AG & SG SIDDHARTHA DEGREE COLLEGE OF ARTS & SCIENCE VUYURU

A.P- 521165

(An autonomous college in the jurisdiction of Krishna university, Machilipatnam)

Course 7B: Tourism Guidance and Operating Skills SECHIS602

(Skill Enhancement Course (Elective), 4 Credits)

II. Learning Outcomes:

Students after successful completion of the course will be able to:

1. Acquire tour guiding, operating and soft skills
2. Understand different situations under which one has to work
3. Cultivate cultural awareness and flexibility
4. Understand and apply team spirit
5. Plan and organize tour operations efficiently

Unit: 1

12hrs

Meaning of tour guide - types of tour guide: heritage guide, nature guide, adventure guide, business guide, special interest guide etc – duties and responsibilities of guides -various roles of tour guide.

Unit: 2

12hrs

Guiding techniques: leadership skills, social skills, presentation skills, communication skills - Guide's personality skills: passion, empathy, enthusiasm, punctuality, humouretc - Personal hygiene and grooming – code of conduct.

Unit: 3

12hrs

Guest Relationship Management- Handling emergency situations- Medical, Personal, Official, VISA/Passport, Death, Handling Guest with special needs/Different Abilities/ Different age groups.

Unit: 4

12hrs

Conducting Tours: Pre-Tour Planning, Route Chart, Modes of Transportation, Security Measures, and Check list etc. - Conducting various types of tours- Relationship with Fellow Guides - Coordination with hospitality institutions.

Unit: 5**12hrs**

Travel Agency and Tour operations – Difference between Travel Agent and Tour operator – Functions of Tour Operator – Types of Tour Operations and of Tour Operators - A brief study of tour operating agencies like APTDC, Southern Travels etc.

III. References:

1. Jagmohan Negi, Travel Agency and Tour Operations, Kanishka Publishers, New Delhi, 2006
2. Mohinder Chand, Travel Agency and Tour Operations: An Introductory Text, Anmol Publications Pvt. Limited, New Delhi, 2009
3. Dennis L Foster – Introduction to Travel Agency Management
4. Pat Yale (1995); Business of Tour Operations, Longman Scientific & Technical, New
5. Pond K L, The Professional Guide: Dynamics of Tour Guiding, 1993
6. www.tourism.gov.in
7. www.qtic.com
9. www.cedeop.europe
10. web sources as suggested by teacher/librarian

IV. Co-Curricular Activities:

- a) Mandatory: (Training of students in the related skills by the Lecturer, Total 10 Hours)
- 1) For Teacher: Training of students by the teacher in the classroom and in the field for a total of not less than 10 hours on various practical skills related to guidance and operating tours in tourism sector, with the help of local experts. The teacher shall lead students to local tourist sites and guide them to work with local tourist guides or local tourist operators.
 - 2) For Student: Students shall individually choose and visit a local tourist place/monument such as a historical site, temple etc., and talk to local guides personally. Observe their functioning to gain experience, including suggestions for the improving the guidance. These individual observations shall be written in the given format not exceeding 10 pages and submit to the teacher as Fieldwork/Project work Report.

3) Suggested Fieldwork/Project work Format:

Title Page, Student Details, Acknowledgments, Index page, Objectives, Step-wise process, Findings & References

4) Max Marks for Fieldwork/Project work Report: 05

5) Unit Tests/Internal Examinations

a) Suggested Co-Curricular Activities

1) Invited Lectures

2) Hands on experience with the help of field experts.

3) Debates on interesting topics

4) Seminars, Group Discussions, Quiz, etc.

5) Assignments

6) Alumni Interactions

7) Periodical interactions with Tour Mana

AG & SG SIDDHARTHA DEGREE COLLEGE OF ARTS & SCIENCE VUYYURU

A.P- 521165

(An autonomous college in the jurisdiction of Krishna university, Machilipatnam)

III BA.Semester – V

Subject; History 3HIS7B

Title of the Paper – TOURISM AND HOSPITALITY SERVICES 7B

Paper Code

Time : 3Hrs

Max. Marks : 70

Model Question Paper

SECTION – A

I. Answer any TWO of the following

2x5=10 M

1. Responsibilities of the Guide?
2. Explain Types of Tour Guide?
3. Explain Guides Personality skills?
4. Handling of the Guest in different situations?

SECTION – B

II. Answer any FOUR of the following

4x15= 60 M

- 5.Explain the meaning of the Tour Guide?
- 6.Explain duties of the Guide?
- 7..Write about the guiding techniques?
- 8.Explain hygiene and grooming of the guide?
- 9.Explain Relationship Management?
- 10..Passport and Visa process?
- 11.Write about Travel Agency and Tour operations?
- 12..Explain the functions of Tour operator?

AG & SG SIDDHARTHA DEGREE COLLEGE OF ARTS & SCIENCE VUYYURU

A.P- 521165

(An autonomous college in the jurisdiction of Krishna university, Machilipatnam)

III BA.Semester – V

Subject; History 3HIS7B

Title of the Paper – TOURISM AND HOSPITALITY SERVICES 7B

Section	Unit – I	Unit – II	Unit – III	Unit - IV	Unit-V
A 5 Marks Questions	2	1		1	
B 15 Marks Questions	1	2	2	1	2
Weightage	35	35	30	20	30

**A.G& S.G.SIDDHARTHA DEGREE COLLEGE OF ARTS &
SCIENCE**

VUYYURU-521165, KRISHNA Dt., A.P.(Autonomous)

Accredited by NAAC with "A" Grade

2022-2023



DEPARTMENT OF MATHEMATICS

MINUTES OF BOARD OF STUDIES

ODD SEMESTER

29-10-2022

Minutes of the meeting of BOS in Mathematics for B. Sc Degree Courses of
AG & SG Siddhartha Degree College of Arts & Science, Vuyyuru, held at 2.30
PM on 29 – 10 – 2022 through online mode.

N.V. Srinivasa Rao

Presiding

Members Present:

- 1) *N.V. Srinivasa Rao*
(N.V. Srinivasa Rao) Chairman Head, Department of Mathematics,
AG & SG S Degree College.
- 2) _____
(Dr. K. Jaya Lakshmi) University Nominee Department of Mathematics,
Krishna University,
Machilipatnam.
- 3) _____
(M. Venkateswara Rao) Subject Expert Department of Mathematics,
Govt. Degree College,
Avanigadda.
- 4) _____
(I. V. Venkateswara Rao) Subject Expert Department of Mathematics,
P. B. Siddhartha College,
Vijayawada
- 5) *D. Sunitha*
(D. Sunitha) Member Lecturer in Mathematics
AG & SG S Degree College.
- 6) *A. Bhargavi*
(A. Bhargavi) Member Lecturer in Mathematics
AG & SG S Degree College.
- 7) *Noor Mohammad*
(Noor Mohammad) Member Lecturer in Mathematics
AG & SG S Degree College.
- 8) *K. Rajya Lakshmi*
(K. Rajya Lakshmi) Member Lecturer in Mathematics
AG & SG S Degree College.
- 9) *G. Jahnvi*
(G. Jahnvi) Student Member III B.Sc M.P.Cs
AG & SG S Degree College.
- 10) *N. Pavan Sai Kumar*
(N. Pavan Sai Kumar) Student Member III B.Sc M.P.C (E)
AG & SG S Degree College.

Agenda of B.O.S Meeting:

1. To discuss and recommend the Syllabi, Model Question Papers and Guidelines to be followed by question paper setters in Mathematics for 1st Semester as per the guidelines and instructions prescribed APSCHE and Krishna University from the Academic Year 2022-23.
2. To discuss and recommend the Syllabi, Model Question Papers and Guidelines to be followed by question paper setters in Mathematics and Analytical Skills for 3rd Semester as per the guidelines and instructions prescribed APSCHE and Krishna University from the Academic Year 2022-23.
3. To discuss and recommend the Syllabi, Model Question Papers and Guidelines to be followed by question paper setters in Mathematics for 5th/ 6th Semester as per the guidelines and instructions prescribed APSCHE and Krishna University from the Academic Year 2022-23.
4. Any other matter.

Resolutions.

1. Discussed and recommended that no changes are required in Syllabi. Changes are required in Model Question Papers and Guidelines to be followed by the question paper setters in Mathematics for 1st Semesters from the Academic year 2022-23. The maximum marks for IA is 30 and SE is 70. Each IA written examination is of 1 Hr. 30 min duration for 20 marks. The tests will be conducted centrally. The average of two such IA is calculated for 20 marks. 5 marks will be allotted for attendance and 5 marks are allotted for Assignment/ Activity. There is no minimum passing for IA and there is no provision for improvement in IA. Even though the candidate is absent for two IA exams/obtain zero marks the external marks are considered (if he/ she gets 40 out of 70) and the result shall be declared as 'PASS' from the Academic year 2022-23.
2. Discussed and recommended that changes are required in Syllabi, Model Question Papers and Guidelines to be followed by the question paper setters in Mathematics and Analytical Skills for all degree programs of 3rd Semesters from the Academic year 2022-23. The maximum marks for IA is 25 and SE is 75. Each IA written examination is of 1 Hr. duration for 15 marks. The tests will be conducted centrally. The average of two such IA is calculated for 15 marks. 5 marks will be allotted basing on Assignment and 5 marks are allotted for activity. There is no minimum passing for IA and there is no provision for improvement in IA. Even though the candidate is absent for two IA exams/obtain zero marks the external marks are considered (if he/ she gets 40 out of 75) and the result shall be declared as 'PASS' from the Academic year 2022-23. There is 10 marks IA (There is no minimum passing for IA) for Analytical Skills and minimum pass marks is 16 out of 40 in SE.
3. Discussed and recommended that changes are required in syllabi, Model Question Papers and Guidelines for question paper setters in Mathematics for the 5th/ 6th Semester for the Academic year 2022-23.
4. Discussed and recommended for organizing seminars, Guest lecturers, Online Examinations and Workshops to upgrade the knowledge of students for Competitive Examinations for the approval of the Academic Council.

N.V. Selivana
Chairman

A . G & S . G Siddhartha Degree College of Arts and Science (Autonomous), Vuyyuru

(An Autonomous College in the jurisdiction of Krishna University, Machilipatnam)
NAAC reaccredited at 'A' level and *ISO 9001 – 2015 Certified*

Department of Mathematics**COURSE STRUCTURE****Paper Title :- DIFFERENTIAL EQUATIONS****Semester : I**

Course Code	MATT11A	Course Delivery Method	Class Room / Blended Mode - Both
Credits	5	CIA Marks	30
No. of Lecture Hours / Week	6	Semester End Exam Marks	70
Total Number of Lecture Hours	90	Total Marks	100
Year of Introduction : 2018-19	Year of Offering: 2022 - 23	Year of Revision: ----	Percentage of Revision: 0%

Programme Outcomes

S. No	P.O
	At the end of the Programme the student will be able to:
1	Demonstrate the ability to use mathematical skills such as formulating and tackling mathematics related problems and identifying and applying approximate physical principles and methodologies to solve a wide range of problems associated with mathematics.
2	Apply the underlying unifying structures of mathematics and the relationships among them.
3	Investigate and apply mathematical problems and solutions in variety of contexts related to science and technology, business and industry.

Course Outcomes of MATT11A

S. No	C.O	Mapping
	Upon successful completion of this course, students should have the knowledge and skills to:	
1	Determine the solution of differential equations of the first order and of the first degree by Exact, Linear and Bernoulli's method.	L2, PO – 1
2	Understand the basic concepts of first order differential equations to find Orthogonal trajectories.	L2, PO - 1
3	Determine the solution of differential equations of the first order and of a degree higher than first by using methods of solvable for P, X, and Y.	L2, PO - 1
4	Compute all solutions of second and higher order linear differential equations with constant coefficients, linear equations with variable coefficients.	L3, PO – 1
5	Calculate the solutions of higher order differential equations by Cauchy Euler and Variation of parameters.	L2, PO – 1

A . G & S . G Siddhartha Degree College of Arts and Science (Autonomous), Vuyyuru

(An Autonomous College in the jurisdiction of Krishna University, Machilipatnam)

MATHEMATICS	MAT T11A	2021 – 22 onwards	B.Sc (MPC, MPCs, MCCS, MSCS)
--------------------	-----------------	--------------------------	-------------------------------------

DIFFERENTIAL EQUATIONS

SEMESTER-I

No of Credits: 5

OBJECTIVES:

1. Understand all of the concepts relating to the order and linearity of ODEs, analytic and computational solution methods for ODEs, and the real-world applications of ODEs.
2. Apply your understanding of the concepts, formulas, and problem-solving procedures to thoroughly investigate relevant physical models.
3. Explain the concepts of linear systems, ODE solution methods, and related ideas at a fundamental level, as well as how and why we use the solution techniques that we use.

UNIT-I: DIFFERENTIAL EQUATIONS OF FIRST ORDER & FIRST DEGREE (12Hrs)

- 1.1 Linear Differential Equations
- 1.2 Differential Equations Reducible to Linear Form, Bernoulli's differential equations.
- 1.3 Exact Differential Equations
- 1.4 Integrating Factors, $1/Mx+Ny$, $1/Mx-Ny$, $e^{\int f(x)} dx$, $e^{\int g(y)} dy$, and Inspection method
- 1.5 Change of Variables

UNIT-II: ORTHOGONAL TRAJECTORIES & DIFFERENTIAL EQUATIONS OF FIRST ORDER BUT NOT FIRST DEGREE (12Hrs)

- 2.1 Orthogonal Trajectories
- 2.2 Self-Orthogonal Trajectories
- 2.3 Equations solvable for p
- 2.4 Equations solvable for y
- 2.5 Equations solvable for x
- 2.6 Equations Homogeneous in X & Y
- 2.7 Equations that do not contain x (or y)
- 2.8 Clairaut's Equation and Equations reducible to Clairaut's form.

UNIT – III: Higher order linear differential equations-I (12Hrs)

- 3.1 Solution of homogeneous linear differential equations of order n with constant coefficients
- 3.2 Solution of the non-homogeneous linear differential equations with constant coefficients by means of polynomial operators.
- 3.3 General Solution of $f(D)y=0$
- 3.4 General Solution of $f(D)y=Q$ when Q is a function of x.
- 3.5 $1/f(D)$ is Expressed as partial fractions.
- 3.6 P.I. of $f(D) y = Q$ when $Q = be^{ax}$
- 3.7 P.I. of $f(D) y = Q$ when Q is $b \sin ax$ or $b \cos ax$.

UNIT – IV: Higher order linear differential equations-II (12Hrs)

- 4.1 Solution of the non-homogeneous linear differential equations with constant coefficients.
- 4.2 P.I. of $f(D) y = Q$ when $Q = bx^k$
- 4.3 P.I. of $f(D) y = Q$ when $Q = e^{ax} V$
- 4.4 P.I. of $f(D) y = Q$ when $Q = xV$
- 4.5 P.I. of $f(D) y = Q$ when $Q = x^m V$ where $v = \sin bx$ and $\cos bx$

UNIT-V: Higher order Differential Equations –III (12Hrs)

- 5.1 The Cauchy-Euler Equation.
- 5.2 Linear differential Equations with non-constant coefficients
- 5.3 Method of Variation of parameters.

Student Activities:

- 1) **Class-room activities:** Power point presentations, Assignments
- 2) **Library activities:** Visit to library and preparation of notes for Assignment problems.
- 3) **Activities in the Seminars, workshops and conferences:** Participation/presentation in seminar/workshop/conference.

CO-CURRICULAR ACTIVITIES:

- Quiz Competitions, Seminars
- Group Discussions

WEB LINKS:

https://en.wikipedia.org/wiki/Differential_equation

<https://tutorial.math.lamar.edu/classes/de/de.aspx>

<https://www.mathsisfun.com/calculus/differential-equations.html>

Prescribed Text book:				
S.NO	AUTHOR	TITLE OF THE BOOK	PUBLISHER	YEAR OF PUBLICATION
1	V. Krishna Murthy	A text book of Mathematics for B.A/B.ScVol – I	S-Chand&co	2015

Reference books:				
S.NO	AUTHOR	TITLE OF THE BOOK	PUBLISHER	YEAR OF PUBLICATION
1	Dr.A. Anjaneyulu	A text book of mathematics for B.A/B.ScVol – I	Deepthi Publications	2015
2	Rai Singhania	Ordinary& Partial Differential Equations	S-Chand	2009
3	Zafar Ahsan	Differential Equations and their applications	Prentice-Hall of India Pvt Ltd, McGraw Hill	2000

Recommended Question Paper Pattern and Model BLUE PRINT FOR QUESTION PAPER
PATTERN COURSE-I, DIFFERENTIAL EQUATIONS

Unit	TOPIC	S.A.Q(including choice)	E.Q(including choice)	Total Marks
I	Differential Equations of 1 st order and 1 st degree	2	2	28
II	Orthogonal Trajectories, Differential Equations of 1 st order but not of 1 st degree	2	2	28
III	Higher Order Linear Differential Equations (with constant coefficients) – I	2	2	28
IV	Higher Order Linear Differential Equations (with constant coefficients) – II	2	2	28
V	Higher Order Linear Differential Equations (with non-constant coefficients)	2	2	28
TOTAL		10	10	140

S.A.Q. = Short answer questions (4 marks)

E.Q. = Essay questions (10 marks)

Total Marks = 70 M

.....

COURSE-I, DIFFERENTIAL EQUATIONS

B.Sc MATHEMATICS MODEL PAPER (W.E.F 2022 – 2023)

Time: 3Hrs

Max.Marks:70M

Answer the following questions.

5 x 14 = 70M

1. (a) i) ----- 10 M
ii) ----- 4M

(OR)

- (b) i) ----- 10M
ii) ----- 4 M

2. (a) i) ----- 10 M
ii) ----- 4M

(OR)

- (b) i) ----- 10M
ii) ----- 4 M

3. (a) i) ----- 10 M
ii) ----- 4M

(OR)

- (b) i) ----- 10M
ii) ----- 4 M

4. (a) i) ----- 10 M
ii) ----- 4M

(OR)

- (b) i) ----- 10M
ii) ----- 4 M

5. (a) i) ----- 10 M
ii) ----- 4M

(OR)

- (b) i) ----- 10M
ii) ----- 4 M

A . G & S . G Siddhartha Degree College of Arts and Science (Autonomous), Vuyyuru

(An Autonomous College in the jurisdiction of Krishna University, Machilipatnam)

NAAC reaccredited at 'A' level and *ISO 9001 – 2015 Certified*

Department of Mathematics

COURSE STRUCTURE

Paper Title :- ABSTRACT ALGEBRA

Semester : III

Course Code	MATT31	Course Delivery Method	Class Room / Blended Mode - Both
Credits	5	CIA Marks	25
No. of Lecture Hours / Week	6	Semester End Exam Marks	75
Total Number of Lecture Hours	90	Total Marks	100
Year of Introduction : 2018-19	Year of Offering: 2022 - 23	Year of Revision: ----	Percentage of Revision: 0%

Programme Outcomes

S. No	P.O
	At the end of the Programme the student will be able to:
1	Demonstrate the ability to use mathematical skills such as formulating and tackling mathematics related problems and identifying and applying approximate physical principles and methodologies to solve a wide range of problems associated with mathematics.
2	Apply the underlying unifying structures of mathematics and the relationships among them.
3	Investigate and apply mathematical problems and solutions in variety of contexts related to science and technology, business and industry.

Course Outcomes of MATT31

S. No	C.O	Mapping
	Upon successful completion of this course, students should have the knowledge and skills to:	
1	Understand concepts of groups and its properties.	L2, PO –1
2	Determine subgroups and whether the given subsets of a group are subgroups.	L4, PO – 1
3	Explain the significance of cosets, normal subgroups and factor groups.	L2,PO – 2
4	Determine group homomorphisms and isomorphisms.	L4, PO – 1

MATHEMATICS	MATT31	2022-2023	B.Sc.(MPC, MPCs, MCCS, MSCS)
-------------	--------	-----------	------------------------------

ABSTRACT ALGEBRA

SEMESTER - III

No of Credits: 5

OBJECTIVE: TO ENHANCE THE DATA EVALUATIONAL SKILLS, LOGICAL THINKINGNESS OF THE STUDENT

UNIT-I : GROUPS

(16hrs)

- 1.1 Binary Operation, Semi group, Algebraic Structure, Monoid, Cancellation laws, Group definition, Abelian group, Elementary Properties.
- 1.2 Finite and Infinite groups with examples, Order of a group with examples.
- 1.3 Addition modulo m – Definition – theorem – Problems.
- 1.4 Multiplication Modulo P – definition- $\{1, 2, 3, \dots, p-1\}$ where P is a prime number is a group – theorem – Problems.
- 1.5 Order of an element of a group – Definition – Theorems.

UNIT-II: SUB GROUPS

(20 hrs)

- 2.1 Complex definition, Multiplication of two complexes, Inverse of a complex, subgroup definition, Identity and Inverse of a subgroup.
- 2.2 Criterion for a complex to be a subgroup, Criterion for the product of two subgroups to be a subgroup.
- 2.3 Union and Intersection of subgroups.
- 2.4 Cosets Definition – Properties of cosets.
- 2.5 Index of a subgroups of a finite groups, Lagrange’s Theorem.

UNIT-III: NORMAL SUBGROUPS

(18 hrs)

- 3.1 Definition of a normal subgroup, Proper and improper normal subgroups.
- 3.2 Intersection of two normal subgroups, Subgroup of index 2 is a normal subgroup, Simple Group.
- 3.3 Quotient group, Criteria for the existence of a Quotient group.

UNIT-IV: HOMOMORPHISM

(16hrs)

- 4.1 Definition of a Homomorphism, Image of a Homomorphism, Properties of a Homomorphism.
- 4.2 Isomorphism, Automorphism definitions and elementary properties.
- 4.3 Kernel of a homomorphism, Fundamental theorem on homomorphism of groups and Applications.
- 4.4 Inner automorphism, Outer automorphism.

UNIT-V: PERMUTATIONS AND CYCLIC GROUPS**(20 hrs)**

- 5.1 Definition of a permutation group, Equal permutations, Permutation multiplications, Order of a permutation, Inverse of a permutation, Orbits and cycles of permutation
- 5.2 Transposition, Even and odd permutations – Theorem – Related Problems.
- 5.3 Cayley's theorem – Related Problems.
- 5.4 Definition of a cyclic group – Properties of Cyclic group.
- 5.5 Standard theorems on cyclic groups – related problems.

Prescribed Text book:				
S.NO	AUTHOR	TITLE OF THE BOOK	PUBLISHER	YEAR OF PUBLICATION
1	V.Venkateswara Rao, BVSS Sharma, S.AnjaneyaSastry & Others	A textbook of mathematics for B.A/B.ScVol – I	S-Chand	2015

Reference books:				
S.NO	AUTHOR	TITLE OF THE BOOK	PUBLISHER	YEAR OF PUBLICATION
1	Dr.A. Anjaneyulu	A text book of mathematics for B.A/B.ScVol – I	Deepthi Publications	2015
2	M.L.Khanna	Modern Algebra	Jaya Prakashnadh & Co	2012

A.G & S.G Siddhartha Degree College of Arts and Science, Vuyyuru

(An Autonomous College in the jurisdiction of Krishna University, Machilipatnam)

SEMESTER – III

Model Paper

COURSE CODE: MATT 31

TITLE OF THE PAPER: ABSTRACT ALGEBRA

Time: 3hrs.

Max. Marks: 75

Section – A

Answer any FIVE questions

5x5=25

1. In a group G , Show that the inverse of an element is unique. (L1,CO1)
2. H is a non-empty complex of a group G . Show that the necessary and sufficient condition for H to be a sub group of G is $a, b \in H \Rightarrow ab^{-1} \in H$. (L1,CO2)
3. Show that any two left (right) cosets of a sub group are either disjoint (or) identical.(L2,CO3)
4. Show that every subgroup of an abelian group is normal. (L3,CO3)
5. Prove that Every Quotient group of an abelian group is abelian. (L2,CO3)
6. If ' f ' is a homomorphism of a group G into a group G' , then show that the Kernel of f is a normal subgroup of G . (L3,CO3)
7. Use Cayley's theorem to find the regular permutation group isomorphic to the multiplicative group $\{1, -1, i, -i\}$. (L3,CO5)
8. Prove that every cyclic group is abelian. (L2,CO5)

Section – B

Answer ALL questions.

(5 x 10 = 50)

Unit - I

9. (a). Prove that the set Z of all integers from an abelian group w.r.t to the operation defined by $a * b = a+b+2 \forall a, b \in Z$. (L3, CO1)
(OR)
(b). Prove that $G = \{0,1,2,3,4,5\}$ is an abelian group w.r.t. addition modulo 6.(L3,CO1)

Unit – II

10. (a). Prove that the union of two sub groups of a group G is a sub group of G if and only if one is contained in the other. (L1,CO2)
(OR)
(b). State and prove Lagrange's theorem on groups. (L1,CO2)

Unit – III

11. (a). If H is a normal subgroup of a group G , then prove that the set of all cosets of H in G is a group with respect to coset multiplication. (L1,CO3)
(OR)
(b). Prove that H is a normal subgroup of a group G iff product of two right cosets of H is again a right coset of H . (L1, CO3)

(P.T.O)

Unit – IV

12. (a).State and Prove Fundamental Theorem of Homomorphism. (L1,CO4)

(OR)

(b).Let 'a' be a fixed element of a group G. Prove that the mapping $f_a : G \rightarrow G$ defined by $f_a(x) = a^{-1}xa \forall x \in G$ is an automorphism of G. (L2, CO4)

Unit - V

13.(a).Prove that every finite group G is isomorphic to a permutation group. (L1,CO5)

(OR)

(b).Prove that every subgroup of a cyclic group is cyclic. (L1,CO5)

A.G & S.G Siddhartha Degree College of Arts and Science, Vuyyuru
(An autonomous college in the jurisdiction of Krishna University, Machilipatnam, A.P., India)

LIFE SKILL COURSE	LSC003	2022 -'23	All Degree Programs
--------------------------	---------------	-----------	---------------------

SEMESTER – III

Credits: 2

(Total 30 Hrs)

ANALYTICAL SKILLS

- CO1: After studying this chapter student update them to analyze the data in Graphs, tables, passages etc.
- CO2: After studying this chapter student understand to find missing object in a sequence and analyze the objects. And also the student easily identify the family relations, find the day of the week for a particular date and improve the calculations in an easy way.
- CO3: After studying this chapter student understand the age related problems and how to calculate speed in different methods and also the student can update themselves to solve business related problems and banking related problems.

UNIT – 1 (5 Hours)

Data Interpretation:-The data given in a Table, Graph, Bar Diagram, Pie Chart, Venn diagram or a passage is to be analyzed and the questions pertaining to the data are to be answered.

UNIT – 2 (10 Hours)

Verbal Reasoning:- Analogies of numbers and alphabets completion of blank spaces following the pattern in A:b::C: d relationship odd thing out; Missing number in a sequence or a series. Coding & Decoding. Calendar Problems, Clock Problems, Blood Relationship

Arithmetic ability:- Algebraic operations BODMAS, Fractions, Divisibility rules, LCM&GCD (HCF).

UNIT - 3 (15Hours)

Quantitative aptitude:- Averages, Ration and proportion, Problems on ages, Time-distance – speed.

Business computations:- Percentages, Profit &loss, Partnership, simple compound interest.

Reference Books:

1. Quantitative Aptitude for Competitive Examination by R S Agrawal, S.Chand publications.
2. Quantitative Aptitude and Reasoning by R V Praveen, PHI publishers.
3. Quantitative Aptitude : Numerical Ability (Fully Solved) Objective Questions, Kiran Prakashan, Pratogitaprakasan, Kic X, Kiran Prakasan publishers
4. Quantitative Aptitude for Competitive Examination by Abhijit Guha, Tata Mc Graw hill publications.
5. Old question Paper of the exams conducted by (Wipro, TCS, Infosys, Etc) at their recruitment process, source-Internet.

Note: The teachers/students are expected to teach /learn the contents by not converting them to the problems of algebra at the maximum possible extent, but to use analytical thinking to solve the exercises related to those topics. This is the main aim of the course.

A.G & S.G SIDDHARTHA DEGREE COLLEGE OF ARTS AND SCIENCE: VUYYURU-521165
(An Autonomous College in the jurisdiction of Krishna University, Machilipatnam)
Accredited with "A" Grade by NAAC, Bengaluru
DEPARTMENT OF MATHEMATICS
ANALYTICAL SKILLS
(Model paper)

TIME:2HRS

MAX.MARKS: 40MARKS

Choose the correct answer from the following.. (80questions* $\frac{1}{2}$ =40M)

Directions (Q.No:1 to 5): Study the following pie chart carefully and answer the questions given below it.

The following Pie chart shows the Hourly distribution
(in degrees) of all the major activities of a Student.

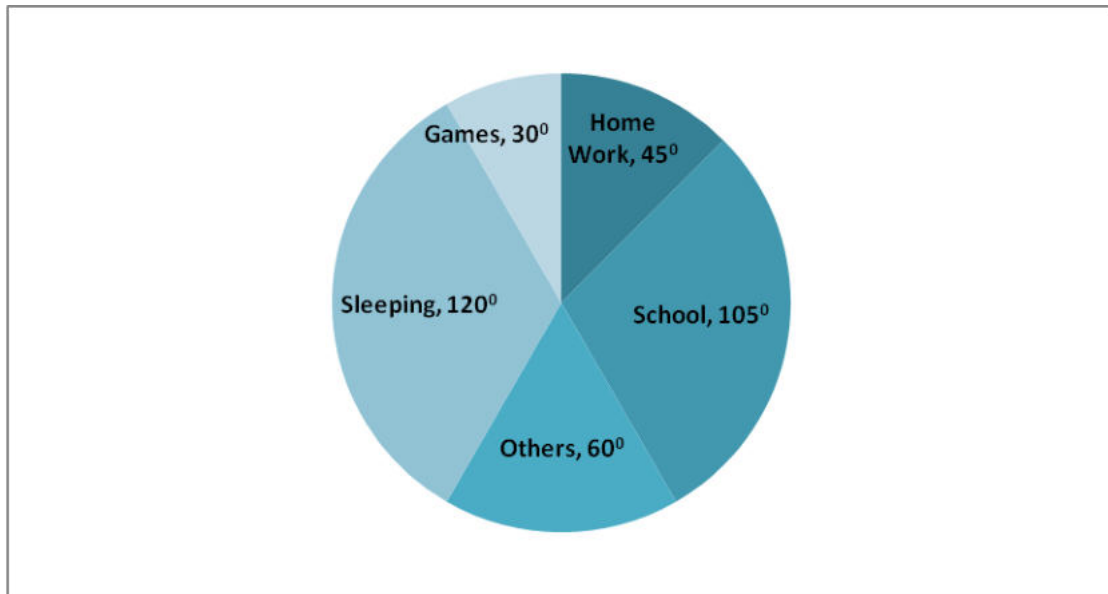

- The Approximate percentage of time, which he spends in School is?
a)38% b)30% c)40% d)25% e)None
- How much time(in percentage) does he spends in games in comparison to sleeping?
a)30% b)40% c)25% d)75% e)None
- What is the ratio of time spend in sleeping to time spend in Home Work respectively?
a)9:5 b)7:4 c)5:2 d)8:3 e)None
- If he spends $\frac{1}{3}$ rd of time for homework in Mathematics, then the number of hours he spends in rest of the subjects in homework is...
a)2hrs b)5hrs c)7hrs d)18hrs e)None
- The ratio of time spend in sleeping and games together to time spend in others respectively
a)9:11 b)5:7 c)13:11 d)7:9 e)None

6. What is the value of $0.99999\dots$ in the form of p/q ?
 a)1 b)1.2 c)2/3 d)7/9 e)None
7. $(4 \times 4 \times 4 \times 4) \div (4 \times 4 \times 4) + 4 = ?$
 a)20 b)4 c)14 d)3/4 e)None
8. Find the square root of 3721
 a)49 b)51 c)61 d)59 e)None
9. Difference of any two even numbers..
 a)Odd b)Even c)Prime d)Composite e)None
10. Find the least value of '*' so that the number $12*25253$ is divisible by 3
 a)3 b)4 c)1 d)2 e)None
11. What is the units place in 2528^{2529}
 a)7 b)1 c)8 d)9 e)None of These
12. Find the LCM of 28, 35, 56 and 84
 a)840 b)140 c)255 d)250 e)None
13. LCM and HCF of two numbers is 180 and 20 respectively. One of the two numbers is 30. find the another number..
 a)100 b)90 c)120 d)70 e)150
14. Find the total number of factors of 169 ?
 a)1 b)2 c)3 d)9 e)None

Directions (Q.No:15 to 19): These questions are based on the data in the following table, study it carefully and answer the questions given below it.

Population (in Lakh) of various states over the years

Years	STATES									
	A	B	C	D	E	F	G	H	I	J
2000	56	37	62	48	63	53	71	69	53	73
2001	64	42	60	46	64	56	72	72	52	75
2002	70	39	63	45	61	52	69	73	55	76
2003	69	43	61	47	65	55	73	68	54	77
2004	73	40	65	49	62	54	71	67	57	79
2005	65	45	66	52	63	58	74	75	56	80
2006	72	47	69	51	60	57	72	74	58	81
2007	77	52	67	52	64	59	75	76	59	83
2008	76	50	68	53	66	60	76	78	60	84
2009	75	53	70	50	68	61	74	77	62	85

15. The population of which state was the highest in the year 2003?
 a)A b)E c)I d)J e)None
16. The population of state C in 2007 was equal to the population of which state in 2004?
 a)A b)H c)I d)J e)None
17. What was the difference between the population of state C in 2007 and state E in 2002
 a)6 lakhs b)7 lakhs c)4 lakhs d)5 lakhs e)None
18. Which state had the lowest population in 2009?
 a)C b)B c)D d)A e)None
19. The population of state 'I' was the lowest in which year?
 a)2008 b)2009 c)2001 d)2000 e)None

20. If $A:B=3:5$ and $B:C=5:3$. Find $A:B:C$?
- a)15:25:15 b)4:5:3 c)3:5:3 d)9:12:20 e)None
21. Rs.189 has been divided among A,B,C in the ratio 2:3:4. What is the share of A?
- a)Rs.48 b)Rs.32 c)Rs.54 d)Rs.42 e)None
22. The salaries of A,B,C are in the ratio 3:5:7. If the increments of 15%,10% and 20% are allowed respectively in their salaries then what will be the new ratio of their salaries?
- a)3:5:7 b)10:11:20 c)23:33:60 d)69:110:168 e)None
23. $A/2=B/3=C/5$ then find $A:B:C$?
- a)2:3:5 b)5:4:3 c)3:4:5 d)4:5:3 e)None
24. A,B and C entered into a partnership. A contributes Rs.3600 for 4 months, B contributes Rs.1800 for 3 months. C contributes Rs.2700 for 5 months. Find the ratio of their profits share.
- a) 16:6:15 b) 36:18:19 c) 3:1:2 d) 5:2:3 e) None
25. If the capitals of P & Q are in the ratio of 7:9 and the times of their investments are in the ratio 81:49. Then find their Profits Ratio?
- a) 4:9 b) 7:9 c) 9:7 d)5:9 e) None
26. A, B and C together started a business and their capitals are in the ratio 5:3:2 the timing of their investments being in the ratio 4:5:6. In what ratio would their profits be distributed?
- a) 20:15:12 b) 12:13:15 c)14:15:16 d) 12:5:5 e) None
27. In a business A,B and C invested Rs.8000, Rs,5000 & Rs.12000 respectively find the share of B in the total profit of 62500/-
- a) Rs.12600 b) Rs. 12800 c) Rs. 12500 d) Rs. 12400 e) None
28. The difference between the ages of Rajesh and Vinod is 9yrs and they are in the ratio 2:3 then the ratio of their ages after 2 yrs is..
- a)10:11 b)10:19 c)20:11 d)20:29 e)None
29. The ratio of the present ages of Father and His son is 4:3. Six years hence it will be 7:6. What is the present age of the son?
- a)7yrs b)5yrs c)10yrs d)9yrs e)None
30. Before 6yrs, the ratio of ages of A & B was 4:5 and present their ages ratio is 6:7. What is the present age of A.?
- a)6yrs b)17yrs c)7yrs d)5yrs e)None

31. The ratio between the present ages of Ramesh and Jayesh is 3:2. 4yrs ago Ramesh's age was 12yrs more than by Jayesh. What is the present age of Ramesh..?

- a)18yrs b)36yrs c)64yrs d)9yrs e)None

Directions(Q.no-32 to 36):

Study the following graph carefully and answer the questions that follow.

Runs scored by three different teams in five different cricket matches

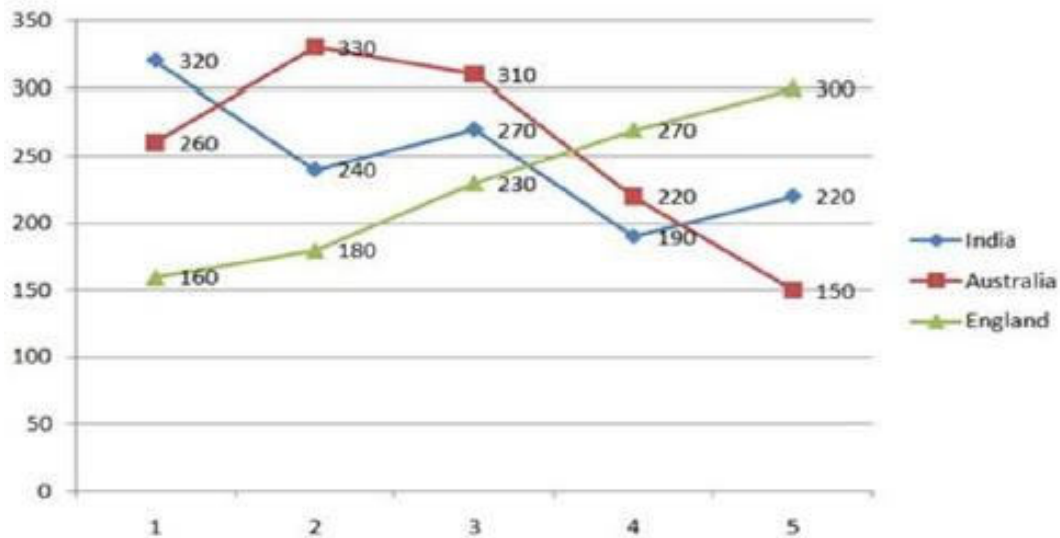

32. Total runs scored by India and Australia in Match 4 together is approximately, what percentage of the total runs scored by England in all five matches together?

- a) 42% b)18% c)36% d)24% e) 28%

33. In which match, is the difference between the runs scored by Australia and England second lowest?

- a) 1 b)2 c)3 d) 4 e)5

34. In which match the total runs scored by India and England is the third highest/lowest?

- a) 1 b)2 c) 3 d) 4 e) 5

35. What is the respective ratio between the runs scored by India in Match 5 Australia in Match 1 and England in Match 2 ?

- a) 11 : 13 : 7 b) 11 : 7 : 13 c)11 : 3 : 9 d)11 : 13 : 9 e)NONE OF THESE

36. What was the average runs scored by all the three teams in Match 3 together?

- a) 280 b)270 c) 275 d)285 e) NONE OF THESE

Directions(Q.No-37 to 41): Complete the Series

37. 64 125 216 343 ___

- a)512 b)513 c)514 d)625 e)None

38. 127 218 345 514 ___

- a)729 b)731 c)730 d)728 e)None

39. 9,27,31,155,161,1127 ___

- a)1144 b)1212 c)1692 d)1135 e)None

40. R U X A D ___
 a)H b)G c)X d)W e)None
41. ABCDEABCDABCA ___
 a)B b)C c)D d)A e)None

Directions(Q.No:42 to 47): Analyse the elements

42. 342:24::543:___
 a)12 b)16 c)60 d)30 e)None
43. 9:18::6:___
 a)24 b)12 c)18 d)21 e)None
44. EIGHTY:GIEYTH::OUTPUT:
 a)TUOTUP b)OUTTUP c)TUOPUT d)PUTTUO e)None
45. A2C:D5F::G8H:___
 a)J 11 L b)I 11 K c)I 10 K d)I 12 M e)None
46. Girl:Beautiful::Boy:___
 a)Smart b)Heroic c)Courageous d)Handsome e)None
47. Train:Trail::Grain:___
 a)Grial b)Grail c)Gairl d)Giarl e)None

Directions(Q.No-48 to 52): Find the odd thing in

48. a)127 b)53 c)63 d)111 e)89
49. a)8 b)12 c)15 d)20 e)24
50. a)A 4 C b)D 10 F c)I 20 K d)G 16 I e)W 25 Y
51. a)47 B144 C)169 d)49 e)64
52. a)51 b)85 c)119 d)102 e)76

53. What % is equivalent to $\frac{3}{4}$?

- (a)50% (b)60% (c)75 % (d)16.66% (e) None of these.

54. What fraction equivalent to 325%?

- (a) $\frac{19}{4}$ (b) $\frac{13}{4}$ (c) $\frac{7}{4}$ (d) $\frac{9}{4}$ (e) None of these.

55. 40% of a number is added to 42.The resultant is that number.Find the number?

- (a) 150 (b) 200 (c) 100 (d) 300 (e) None of these.

56. The population of village is decreased from 4000 to 3500. Find the decreased percentage?

- (a) 25% (b) 22.5% (c) 12.5% (d) 14.5% (e) None of these

57. The ratio between the cost price and selling price is 9:11. Find the profit percentage?

- a)25% b)22.33% c)22.11% d)22.22% e)None

58. A dishonest dealer sold his goods at cost price but he uses 2 kg instead of 3kg. Then what is the profit percentage?

- a)50% b)25% c)12% d)33.33% e)None

59. Rajesh sold a TV set for Rs.2500 at 25% profit then what is cost price of the TV set?

- a)Rs.1000 b)Rs.2750 c)Rs.2220 d)Rs.2400 e)None

60. Arun sold an article for Rs.3200 at a loss of 20% find the cost price?
 a)Rs.2000 b)Rs.1800 c)Rs.3200 d)Rs.4000 e)None
61. Pointing a photograph of Arshita, Rajesh said, "Her father is the only son of my father." How is Arshita related to Rajesh?
 a)mother b)sister c)niece d)daughter e)none
62. A and B are children of C. C is the father of A but B is not the son of C. How is A related to C?
 a)daughter b)cousin c)son d)nephew e)none
63. What is my mother's husband's father-in-law's son's daughter to me ?
 a)brother b)brother-in-law c)uncle d)cousin e)None of these
64. Pointing to a man in photograph, Asha said, "His mother's only daughter is my mother."
 How is Asha related to that man?
 a)nephew b)sister c)wife d)niece e)none
65. April 16th 2019 was Tuesday. What day of the week will it be on January 26th 2020.
 (a)Wednesday (b)Tuesday (c)sunday (d)Saturday (e)None of these.
66. The year next to 2019 having same calendar as that of 2019 is
 (a)2020 (b)2025 (c)2030 (d)2031 (e)None of these.
67. Find the number of odd days on 226 days
 (a)6 (b)3 (c)2 (d)5 (e) None of these.
68. Number of odd days in 1600 years?
 (a)3 (b)1 (c)5 (d)0 (e)None of these.
69. Express 150mps in kmph.?
 a)250kmph b)590kmph c)580kmph d)540kmph e)None
70. The speed of a car is 30kmph after completion every one hour the speed of the car is increased by 2kmph. How much distance travelled by the car in 10hrs?
 a)390km b)200km c)210km d)305km e)None
71. Ram goes to city B from city A at 80kmph and returns to A from B at 30kmph. What is the average speed of the whole journey?
 a)48kmph b)60kmph c)65kmph d)35kmph e)None
72. The speed of a train is 90kmph. What is the distance covered by it in 25seconds?
 a)500m b)600m c)575m d)625m e)None

73. What is the mirror image of 12:30 AM

- a)11:30am b)11:30pm c)12:30pm d)10:30pm e)None

74. How many times the hands of a clock coincide in 24 hours

- a)12 b)11 c)13 d)22 e)NoneOfThese

75. At what angle the hands of a clock are coincide when the time is 10:20PM

- a)190⁰ b)160⁰ c)120⁰ d)110⁰ e)NoneOfThese

76. The hands of a correct clock coincide after every?

- a)60min b)65 $\frac{5}{11}$ min c)64 $\frac{6}{11}$ min d)65min e)NoneOfThese

77. A person borrow Rs.5000 at $16\frac{2}{3}\%$ (mixed fraction) per annum after 3 years how much amount will he pay (if simple interest is calculated annually)

- a)Rs.7000 b) Rs.8000 c) Rs 7500 d) Rs.8500 e) None of these

78. A person borrow Rs.4000 at 10% per annum after 2 years how much amount will he pay (if compound interest is calculated annually)

- a) Rs.4440 b) Rs.4242 c) Rs.4700 d) Rs.4840 e) None of these

79. A person borrow Rs.10000 at 30% per annum after 2 years how much interest will he pay (if compound interest is calculated annually)

- a) Rs.6500 b) Rs.6900 c) Rs.6000 d) Rs.7900 e) None of these

80. A lent Rs.1,20,000 to B. After 5yrs A received Rs.36,000 as interest. Find the rate of interest per annum (if simple interest is calculated annually)

- a)42% b)14% c)4% d)8% e)6%

A.G & S.G SIDDHARTHA DEGREE COLLEGE OF ARTS & SCIENCE
(An Autonomous College in the jurisdiction of Krishna University, Machilipatnam)

2022 - 2023

Course Code: **SECMAT501**

Domain Subject: **MATHEMATICS**

Max. Marks: **100** (CCIA: 30 + SEE: 70)

Offered to: MPC, MPCs, MCCs

Semester – **V**

Theory Hrs./Week: **6**

Course 6B: MULTIPLE INTEGRALS AND APPLICATIONS OF VECTOR CALCULUS

Type of the Course: (**Skill Enhancement Course** (Elective)),

Credits: 05

I. Course Outcomes: Students at the successful completion of the course will be able to:

CO1: Students learn about Multiple Integrals, Change of Order of Integration in Double Integral, Area and Volume by Double Integration. Triple Integrals.

CO2: To set up and evaluate multiple integrals for regions in the plane. To find Area of the region bounded by curves and to find volume, surface area, Mass, C.G and M.I of solid geometric figures.

CO3: Recognize vector fields and vector calculus, and define Gradient, Divergence and Curl operators.

CO4: Compute the derivatives and line integrals, surface integrals and volume integrals of vector functions and learn their Applications.

CO5: Students learn Green's theorem, Gauss Divergence theorem, Stoke's theorem and applications to evaluating line integrals and finding areas.

II. Syllabus:

(Total Theory Hours: 75)

UNIT-I: MULTIPLE INTEGRALS – I

(15 Periods)

1.1 Introduction, Double integrals, Evaluation of double integrals, Properties of double integrals.

1.2 Region of integration, double integration in Polar Co-ordinates,

1.3 Change of variables in double integrals, change of order of integration.

UNIT-II: MULTIPLE INTEGRALS – II

(15 Periods)

2.1 Triple integral, region of integration, change of variables.

2.2 Plane areas by double integrals, surface area by double integral.

2.3 Volume as a double integral, volume as a triple integral.

UNIT-III: VECTOR DIFFERENTIATION

(15 Periods)

3.1 Vector differentiation, ordinary derivatives of vectors.

3.2 Differentiability, Gradient, Divergence, Curl operators,

3.3 Formulae involving the separators.

UNIT-IV: VECTOR INTEGRATION

(15 Periods)

- 4.1 Line Integrals with examples.
- 4.2 Surface Integral with examples.
- 4.3 Volume integral with examples.

UNIT-V: VECTOR INTEGRATION APPLICATIONS

(15 Periods)

- 5.1 Gauss theorem and applications of Gauss theorem.
- 5.2 Green's theorem in plane and applications of Green's theorem.
- 5.3 Stokes's theorem and applications of Stokes theorem.

III References/ Text Book/ e-books/websites

1. Dr.M Anitha, Linear Algebra and Vector Calculus for Engineer, Spectrum University Press, SR Nagar, Hyderabad-500038, INDIA.
2. Dr.M.Babu Prasad, Dr.K.Krishna Rao, D.Srinivasulu, Y.AdiNarayana, Engineering Mathematics-II, Spectrum University Press, SR Nagar, Hyderabad-500038,INDIA.
3. V.Venkateswararao, N. Krishnamurthy, B.V.S.S.Sarma and S.Anjaneya Sastry, A text Book of B.Sc., Mathematics Volume-III, S. Chand & Company, Pvt. Ltd., Ram Nagar, NewDelhi-110055.
4. R.Gupta, Vector Calculus, Laxmi Publications.
5. P.C.Matthews, Vector Calculus, Springer Verlag publications.
6. Web resources suggested by the teacher and college librarian including reading material.

Reference Materials on the Web/web-links:

https://mate.unipv.it/moiola/ReaDG/VC2016/VectorCalculus_LectureNotes_2016.pdf

IV Co-Curricular Activities:

A) Mandatory:

For Teacher: Teacher shall train students in the following skills for 15 hours, by taking Relevant outside data (Field/Web).

1. The methods of evaluating double integrals and triple integrals in the class room and train to evaluate these integrals of different functions over different regions.
2. Applications of line integral, surface integral and volume integral.
3. Applications of Gauss divergence theorem, Green's theorem and Stokes's theorem.

For Student: Project work Each student individually shall undertake Project work and submit a report not exceeding 10 pages in the given format on the work-done in the areas like the following, by choosing any one of the following aspects.

1. Going through the web sources like Open Educational Resources to find the values of double and triple integrals of specific functions in a given region and make conclusions. (or)
2. Going through the web sources like Open Educational Resources to evaluate line integral, surface integral and volume integral and apply Gauss divergence theorem, Green's theorem and Stokes theorem and make conclusions.

Max. Marks for Project work Report: 5.

Suggested Format for Project work Report:

Title page, Student Details, Index page, Stepwise work-done, Findings, Conclusions and Acknowledgements.

Comprehensive Continuous Assessment Test (CCIA):

(2 tests will be conducted each carries 20 Marks, consider Average Mark: 20)

B) Suggested Co-Curricular Activities:

1. Assignments, Seminar, Quiz, Group discussions/Debates.
2. Visits to research organizations, Universities, ISI etc.
3. Invited lectures and presentations on related topics by experts in the specified area.

**A.G & S.G SIDDHARTHA DEGREE COLLEGE OF ARTS AND SCIENCE,
VUYYURU – 521165, KRISHNA Dt., A.P.**

(An Autonomous College in the jurisdiction of Krishna University, Machilipatnam)
Accredited with “A” Grade by NAAC, Bengaluru

EXAMINATION AT THE END OF SEMESTER (w.e.f 2022-23)

MATHEMATICS Paper VI SECMAT-501 MAX.MARKS: 70 TIME: 3 hrs

MULTIPLE INTEGRALS AND APPLICATIONS OF VECTOR CALCULUS

Section – A (short answer questions)

Answer any Four of the following questions.

4x5 = 20M

- 1.
- 2.
- 3.
- 4.
- 5.
- 6.
- 7.
- 8.

Section – B (long answer questions)

Answer any FIVE of the following questions.

5x10 = 50M

- 9.
- 10.
- 11.
- 12.
- 13.
- 14.
- 15.
- 16.

A.G & S.G SIDDHARTHA DEGREE COLLEGE, VUYYURU
(An Autonomous College in the jurisdiction of Krishna University, Machilipatnam)
Accredited with “A” Grade by NAAC, Bengaluru

DEPARTMENT OF MATHEMATICS

Guidelines of III B.Sc for Question Paper Setters V/VI Semester-End Exams: 2022-23

Time: 3 Hrs

SECMAT501

Max.Marks:70

Paper Title: MULTIPLE INTEGRALS AND APPLICATIONS OF VECTOR CALCULUS

Note :- 1). Answer any FOUR questions out of 8 in Section-A.

Each question carries 5 marks.

(4x5=20 Marks)

2). Answer any FIVE questions out of 8 in Section-B.

Each question carries 10 marks.

(5x10 =50 marks)

Questions to be set as follows:

	Unit-1	Unit-2	Unit-3	Unit-4	Unit-5
<u>Section-A</u> (Short Answer Questions)	1	1	2	2	2
<u>Section-B</u> (Essay Questions)	1	1	2	2	2

-The End -

A.G & S.G SIDDHARTHA DEGREE COLLEGE OF ARTS & SCIENCE
(An Autonomous College in the jurisdiction of Krishna University, Machilipatnam)

2022 - 2023

Course Code: **SECMAT502**

Domain Subject: **MATHEMATICS**

Max. Marks: **100** (CCIA: 30+ SEE: 70)

Offered to: MPC, MPCS, MCCs

Semester – **V**

Theory Hrs./Week: **6**

Course 7B: INTEGRAL TRANSFORMS WITH APPLICATIONS

Type of the Course: (**Skill Enhancement Course** (Elective)),

Credits: 05

I. Course Outcomes: Students at the successful completion of the course will be able to:

- CO1: Evaluate Laplace transforms of certain functions, find Laplace transforms of derivatives and integrals.
- CO2: Determine properties of Laplace transform which may be solved by application of special functions namely Dirac delta function, error function, Bessel function and periodic function.
- CO3: Understand properties of inverse Laplace transforms, find inverse Laplace transforms of derivatives and of integrals.
- CO4: Solve ordinary differential equations with constant/ variable coefficients by using Laplace transforms method.
- CO5: Comprehend the properties of Fourier transforms and solve problems related to finite Fourier transforms.

II. Syllabus:

(Total Theory Hours: 75)

UNIT-I: LAPLACE TRANSFORMS – I

(15 Periods)

- 1.1 Definition of Laplace transform, linearity property-piecewise continuous function.
- 1.2 Existence of Laplace transform, functions of exponential order and of class A.
- 1.3 First shifting theorem, second shifting theorem and change of scale property.

UNIT-II: LAPLACE TRANSFORMS – II

(15 Periods)

- 2.1 Laplace Transform of the derivatives, initial value theorem and final value theorem. Laplace transforms of integrals.
- 2.2 Laplace transform of $t^n \cdot f(t)$, division by t , evolution of integrals by Laplace transforms.
- 2.3 Laplace transform of some special functions-namely Dirac delta function, error function, Bessel function and Laplace transform of periodic function.

UNIT-III: INVERSE LAPLACE TRANSFORMS

(15 Periods)

- 3.1 Definition of Inverse Laplace transforms, linear property, first shifting theorem, second shifting theorem, change of scale property, use of partial fractions.
- 3.2 Inverse Laplace transforms of derivatives, inverse, Laplace transforms of integrals, multiplication by powers of 'p', division by 'p'.
- 3.3 Convolution, convolution theorem proof and applications.

UNIT-IV: FOURIER SERIES

(15 Periods)

- 4.1 Introduction, Euler's formulae for Fourier series expansion of a function $f(x)$, Dirichlet's conditions for Fourier series, convergence of Fourier series.
- 4.2 Functions having arbitrary periods. Change of interval, half range series.
- 4.3 Parseval's theorem, illustrative examples based on Parseval's theorem, some particular series.

UNIT-V: FOURIER TRANSFORMS

(15 Periods)

- 5.1 Integral transforms, Fourier integral theorem (without proof), Fourier sine and cosine integrals.
- 5.2 Properties of Fourier transforms, change of scale property, shifting property, modulation theorem.
- 5.3 Convolution, Convolution theorem for Fourier transforms, Parseval's Identify, finite Fourier transforms.

III References/ Text Book/ e-books/websites

1. Dr. S.Sreenadh, S.Ranganatham, Dr.M.V.S.S.N.Prasad, Dr. V.Ramesh Babu, Fourier series and Integral Transforms, S. Chand & Company, Pvt. Ltd., Ram Nagar, New Delhi-110055.
2. A.R. Vasistha, Dr. R.K. Gupta, Laplace Transforms, Krishna Prakashan Media Pvt. Ltd. Meerut.
3. M.D.Raisinghania, H.C. Saxsena, H.K. Dass, Integral Transforms, S. Chand & Company Pvt. Ltd., Ram Nagar, New Delhi-110055.
4. Dr. J.K. Goyal, K.P. Gupta, Laplace and Fourier Transforms, Pragathi Prakashan, Meerut.
5. Shanthi Narayana, P.K. Mittal, A Course of Mathematical Analysis, S. Chand & Company Pvt.Ltd. Ram Nagar, New Delhi-110055.
6. Web resources suggested by the teacher and college librarian including reading material.

Reference Materials on the Web/web-links:

1. <http://aurora.phys.utk.edu/~forrest/papers/fourier/index.html> An introduction to the Fourier Transform, Fast Fourier Transform, and Discrete Fourier Transform.
2. <http://risc1.numis.nwu.edu/fft/> Public Domain code related to Fast Fourier Transforms.

IV) Co-Curricular Activities:

A) Mandatory:

For Teacher: Teacher shall train students in the following skills for 15 hours, by taking Relevant outside data (Web).

1. Demonstrate on sufficient conditions for the existence of the Laplace transform of a function.
2. Evaluation of Laplace transforms and methods of finding Laplace transforms.
3. Evaluations of Inverse Laplace transforms and methods of finding Inverse Laplace transforms.
4. Fourier transforms and solutions of integral equations.

For Student: Project work: Each student individually shall undertake Project work and submit a report not exceeding 10 pages in the given format on the work-done in the areas like the following, by choosing any one of the aspects.

1. Going through the web sources like Open Educational Resources on Applications of Laplace transforms and Inverse Laplace transforms to find solutions of ordinary differential equations with constant /variable coefficients and make conclusions. (or)
2. Going through the web sources like Open Educational Resources on Applications of convolution theorem to solve integral equations and make conclusions. (or)
3. Going through the web source like Open Educational Resources on Applications of Fourier transforms to solve integral equations and make conclusions.

Max. Marks for Project work Report: 5.

Suggested Format for Fieldwork/Project work Report: Title page, Student Details, Index page, Stepwise work-done, Findings, Conclusions and Acknowledgements.

Comprehensive Continuous Assessment Test (CCIA):

(2 tests will be conducted each carries 20 Marks, consider Average Mark: 20)

B) Suggested Co-Curricular Activities:

1. Assignments/collection of data, Seminar, Quiz, Group discussions/Debates
2. Visits to research organizations, Universities, ISI etc.
3. Invited lectures and presentations on related topics by experts in the specified area.

**A.G & S.G SIDDHARTHA DEGREE COLLEGE OF ARTS AND SCIENCE,
VUYYURU – 521165, KRISHNA Dt., A.P.**

(An Autonomous College in the jurisdiction of Krishna University, Machilipatnam)
Accredited with “A” Grade by NAAC, Bengaluru

EXAMINATION AT THE END OF THE SEMESTER (w.e.f 2022-23)

MATHEMATICS Paper VII SECMAT-502 MAX.MARKS: 70 TIME: 3 hrs

INTEGRAL TRANSFORMS WITH APPLICATIONS

Section – A (short answer questions)

Answer any **Four** of the following questions.

4x5 = 20M

- 1.
- 2.
- 3.
- 4.
- 5.
- 6.
- 7.
- 8.

Section – B (long answer questions)

Answer any **FIVE** of the following questions.

5x10 = 50M

- 9.
- 10.
- 11.
- 12.
- 13.
- 14.
- 15.
- 16.

A.G & S.G SIDDHARTHA DEGREE COLLEGE, VUYYURU
(An Autonomous College in the jurisdiction of Krishna University, Machilipatnam)
Accredited with “A” Grade by NAAC, Bengaluru

DEPARTMENT OF MATHEMATICS

Guidelines of III B.Sc for Question Paper Setters V/VI Semester-End Exams: 2022-23

Time: 3 Hrs

SECMAT502

Max.Marks:70

Paper Title: INTEGRAL TRANSFORMS WITH APPLICATIONS

Note :- 1). Answer any FOUR questions out of 8 in Section-A.
Each question carries 5 marks.

(4x5=20 Marks)

2). Answer any FIVE questions out of 8 in Section-B.
Each question carries 10 marks.

(5x10 =50 marks)

Questions to be set as follows:

	Unit-1	Unit-2	Unit-3	Unit-4	Unit-5
<u>Section-A</u> (Short Answer Questions)	2	2	2	1	1
<u>Section-B</u> (Essay Questions)	2	2	2	1	1

-The End -

**A.G& S.G.SIDDHARTHA DEGREE COLLEGE OF ARTS &
SCIENCE**

VUYYURU-521165, KRISHNA Dt., A.P.(Autonomous)

Accredited by NAAC with "A" Grade

2022-2023



**DEPARTMENT OF PHYSICS
MINUTES OF BOARD OF STUDIES**

ODD SEMESTER







26-10-2022

Minutes of the meeting of Board of studies in Physics for the Autonomous course of A.G. & S.G. Siddhartha Degree College of Arts & Science, Vuyyuru held at 2.30 P.M on 26 - 10 - 2022 in the Department of Physics.

Sri J. Hareesh Chandra

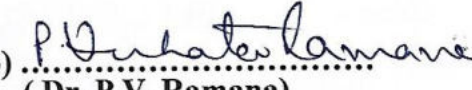
Presiding

Members Present:

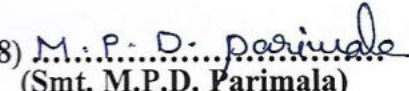
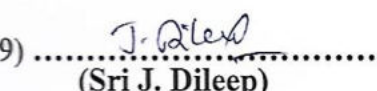
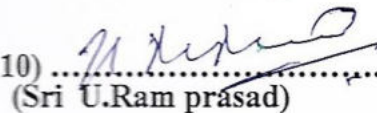
- 1)  Chairman
(Sri J. Hareesh Chandra) Head, Department of Physics
A.G. & S.G.S. Degree College
of Arts & Science, Vuyyuru
- 521165
- 2)  University Nominee
(Dr. M. Rami Reddy) Registrar
Krishna University,
Machilipatnam.
- 3)  Academic Council
(Dr. P.V. Ramana) Nominee H.O.D. Dent. of Physics,
SRI DNR Women's
College, Palakollu.
- 4)  Academic Council
(Dr. T. Srinivasa Krishna) Nominee Associate Professor,
H.O.D, Dept. of Physics,
P.B.Siddhartha College of
Arts & Science,
Vijayawada
- 5)  Representative from
(Sri I. Chintubabu) Industry Sub Divisional Engineer
BSNL , Vijayawada.
- 6)  Alumni
(Sri B. Dileep Kumar) Lecturer in Physics,
Dept.ofPhysics,IIIT,
Nuzivid.
- 7)  Member
(Sri M. Sateesh) Lecturer in Physics,
A.G.&S.G.S.Degree
College of Arts &
Science, Vuyyuru -
521165.
- 8)  Member
(Smt. M.P.D. Parimala) Lecturer in Physics
A.G. & S.G.S.Degree
College of Arts
& Science, Vuyyuru -
521165.
- 9)  Member
(Sri J. Dileep) Lecturer in Physics
A.G.&S.G.S.Degree
College of Arts & Science,
Vuyyuru - 521165.
- 10)  Member
(Sri U. Ram prasad) Lecturer in Physics,
A .G. & S.G.S.Degree,
College of Art. &
Science, Vuyyuru -521165

Agenda for B.O.S Meeting

1. To recommend the syllabi (Theory & Practical) and model paper for I semester of I Degree B.Sc (MPC, MPCs) Physics for the Academic year 2022-2023.
2. To recommend the syllabi (Theory & Practical) and model paper for III semester of II Degree B.Sc (MPC, MPCs) Physics for the Academic year 2022-2023.
3. To recommend the syllabi (Theory & Practical) and model paper for V semester of III Degree B.Sc (MPC, MPCs) Physics for the Academic year 2022-2023.
4. To recommend Skill Development Course “ELECTRICAL APPLIANCES” for II year (III SEMESTER) students in this academic year 2022-23.
5. To recommend the Blue print of question papers for I, III & V semesters of B.Sc. Physics for the Academic year 2022-2023.
6. To recommend the Guidelines to be followed by the question paper setters in Physics for I, III & V Semester – end exams.
7. To recommend the teaching and evaluation methods to be followed under Autonomous status.
8. Any suggestions regarding seminars, workshops, Guest lecture to be organized.
9. Recommend the panel of paper setters and Examiners to the controller of Examinations of autonomous Courses of A.G. & S.G.S.Degree colleges of Arts & Science, Vuyyuru.
10. Any other matter.

Chairman

RESOLUTIONS

The following resolutions are made in Board of studies in Physics for UG Programs of Odd - semester to recommend to the Academic Council for its approval.

1. It is resolved and recommended to continue the course with title “Mechanics, Waves and Oscillations” in I semester of B.Sc.(M.P.C & M.P.Cs.) for both theory and practical with no modifications for the batch of students admitted in 2022-23 and onwards. Model paper is prepared with levels of Bloom’s Taxonomy.
2. It is resolved and recommended to continue the course with title “Heat and Thermodynamics” in the III semester of B.Sc (M.P.C & M.P.Cs) for both theory and practical with no modifications for the batch of students admitted in the academic year 2021-22 and onwards. Model paper is prepared with levels of Bloom’s Taxonomy.
3. It is resolved and recommended the Skill Development Course “ ELECTRICAL APPLIANCES” in the III semester for the students admitted in the academic year 2021-22 and onwards.
4. As per the direction of APSCHE and Krishna University, it is mandatory to introduce Skill Enhancement courses for Semester-V. Therefore, the BOS committee chosen one pair from three alternate pairs from SECs. The titles of the courses are “APPLICATIONS OF ELECTRICITY AND ELECTRONICS” and “ELECTRONIC INSTRUMENTATION” for both theory and practical in the V-semester of B.Sc. (M.P.C, M.P.CS) and VI-semester of B.Sc. (M.P.C & M.P.CS) for the students admitted in the academic year 2020-21 and onwards. The modifications are made as per the recommendations of the BOS committee.
5. As per the direction of APSCHE and Krishna University, an INTERNSHIP is mandatory for final year B.Sc. students. So, the BOS committee recommended and approved the same.

1. It is resolved to follow the changed syllabi and model papers for I semester of I B.Sc. as per APSCHE guidelines from the Academic year 2022-2023.
2. It is resolved to follow the changed syllabi and model papers for III semester of II B.Sc. as per APSCHE guidelines from the Academic year 2022-2023.
3. It is resolved to follow the changed syllabi and model papers for v semester of III B.Sc. as per APSCHE guidelines from the Academic year 2022-2023 .
4. It is resolved to follow the Blue prints as proposed by members of BOS I,III& V semester of Degree B.Sc.for the Academic year 2022-2023.
5. It is resolved to follow the guidelines to be followed by the question paper setters of physics for I, III& V semesters of Degree B.Sc. for the Academic Year 2022-2023.
6. It is resolved to continue the following teaching and evolution methods for Academic year 2022-2023.

Teaching Methods:

Besides the conventional methods of teaching, we use modern technology i.e. using of LCD projector, U boards, virtual lab etc, for better understanding of concepts.

Evaluation of a student is done by the following procedure:

Internal Assessment Examinations:

- For I B.Sc (sem I), out of 100 marks in each paper, 30 marks shall be allocated for internal assessment.
- For II B.Sc (sem III), out of 100 marks in each paper, 25 marks shall be allocated for internal assessment.
- For III B.Sc (sem V) , out of 100 marks in each paper, 30 marks shall be allocated for internal assessment
- For I st Semester, Out of these 30 marks, 20 marks are allocated for announced tests (i.e. IA-1 & IA-2). Two announced tests will be conducted and average of these two tests shall be deemed as the marks obtained by the student, 5 marks are allocated on the basis of candidate's percentage of attendance, 5 marks are allocated for assignment /Activity .
- For III rd semester, Out of these 25 marks, 15 marks are allocated for announced tests (i.e. IA-1 & IA-2) . Two announced tests will be conducted and average of these two tests shall be deemed as the marks obtained by the student, 5 marks are allocated for assignment , 5 marks are allocated for component (class room seminars/group discussion) .

- for V th Semester, Out of these 30 marks, 20 marks are allocated for announced tests (i.e. IA-1 & IA-2). Two announced tests will be conducted and average of these two tests shall be deemed as the marks obtained by the student, 5 marks are allocated on the basis of candidate's percentage of attendance, 5 marks are allocated for assignment / class room seminars .

Semester – End Examination:

- The maximum marks for I B.SC, I Semester – End examination shall be 70 marks and duration of the examination shall be 3 hours.
 - The maximum marks for II B.SC, III Semester – End examination shall be 75 marks and duration of the examination shall be 3 hours.
 - The maximum marks for III B.SC. Semesters – End examination shall be 70 marks and duration of the examination shall be 3 hours.
 - Semester End examinations in theory papers and practical Examinations shall be conducted at the end of every semesters I, III & V
7. Discussed and recommended for organizing seminars, Guest lecturers, workshops to upgrade the knowledge of students, for the approval of the academic council.
 8. Discussed and empowered the Head of the department of Physics to suggest the panel of paper setters and examiners to the controller of examinations.
 9. Nil.

Chairman

LIST OF THE COURSES REVISED/ INTRODUCED IN I, III and V SEMESTERS 2022-2023

S.NO	Course	Course Code	Offered in SEM	Type of the Paper	Year of Introduction	Year of Revision	Revision /Introduce	OBE with BTL	Offerd to
1	Mechanics, waves and oscillations	PHYT11B	I	Core	2020-2021	2021-2022	No Revision	yes	B.Sc. (MPC & MPCS)
2	Mechanics, waves and oscillations lab	PHYP11B	I	Core lab	2020-2021	Nil	No Revision	yes	B.Sc. (MPC & MPCS)
3	Heat and Thermodynamics	PHYT31A	III	Core	2020-2021	2021-2022	No Revision	yes	B.Sc. (MPC & MPCS)
4	Heat and Thermodynamics lab	PHYP31A	III	Core lab	2020-2021	Nil	No Revision	yes	B.Sc. (MPC & MPCS)
5	ELECTRICAL APPLIANCES	SDCPHYT01	III	SDC	2020-2021	Nil	No Revision	yes	----
6	Optical instruments and optometry	6A	V	Skill Enhancement course (Elective)	2022-2023	-	Introduced	yes	B.Sc. (MPC,MP CS)
7	Optical instruments and optometry lab	6A	V	Skill Enhancement course (Elective)	2022-2023	-	Introduced	yes	B.Sc. (MPC.MP CS)
8	Optical Imaging and photography	7A	V	Skill Enhancement course (Elective)	2022-2023	-	Introduced	yes	B.Sc. (MPC,MP CS)
9	Optical Imaging and photography lab	7A	V	Skill Enhancement course (Elective)	2022-2023	-	Introduced	yes	B.Sc. (MPC,MP CS)
10	Low temperature physics and refrigeration	6B	V	Skill Enhancement course (Elective)	2022-2023	-	Introduced	yes	B.Sc. (MPC,MP CS)
11	Low temperature physics and refrigeration lab	6B	V	Skill Enhancement course (Elective)	2022-2023	-	Introduced	yes	B.Sc. (MPC,MP CS)
12	Solar Energy and applications	7B	V	Skill Enhancement course (Elective)	2022-2023	-	Introduced	yes	B.Sc. (MPC,MP CS)
13	Solar Energy and applications lab	7B	V	Skill Enhancement course (Elective)	2022-2023	-	Introduced	yes	B.Sc. (MPC,MP CS)
14	Applications of Electricity and Electronics	SECPHY501 C	V	Skill Enhancement course (Elective)	2022-2023	-	Introduced	yes	B.Sc. (MPC,MP CS)
15	Applications of Electricity and Electronics lab	SECPHY501 P	V	Skill Enhancement course (Elective lab)	2022-2023	-	Introduced	yes	B.Sc. (MPC,MP CS)
16	Electronic Instrumentation	SECPHY502 C	V	Skill Enhancement course (Elective)	2022-2023	-	Introduced	yes	B.Sc. (MPC,MP CS)
17	Electronic Instrumentation lab	SECPHY502 P	V	Skill Enhancement course(Elective lab)	2022-2023	-	Introduced	yes	B.Sc. (MPC,MP CS)

				MARKS	MARKS	DURATION
PHYT11B	Mechanics, waves and oscillations	4	3	30	70	3 Hrs.
PHYP11B	Mechanics, waves and oscillations lab	2	2	10	40	3 Hrs.

SEMESTER – I

SEMESTER- III

Course Code	Title of the Course	Instruction Hours per week	Credits	Evaluation		
				CIA MARKS	SEE	
					MARKS	DURATION
PHYT31A	Heat and Thermodynamics	4	3	25	75	3 Hrs.
PHYP31A	Heat and Thermodynamics lab	2	2	10	40	3 Hrs.
SDCPHY T01	ELECTRICAL APPLIANCES	2	2	10	40	2 Hrs.

SEMESTER – V

Course Code	Title of the Course	Instruction Hours per week	Credits	Evaluation	
				CIA	

				MARK	SEE	
				S	MARKS	DURATION
6A	Optical instruments and optometry	3	3	30	70	3 Hrs.
6A	Optical instruments and optometry lab	3	2	25	25	3 HRS
7A	Optical Imaging and photography	3	3	30	70	3 HRS
7A	Optical Imaging and photography lab	3	2	25	25	3 HRS
6B	Low temperature physics and refrigeration	3	3	30	70	3 HRS
6B	Low temperature physics and refrigeration lab	3	2	25	25	3 HRS
7B	Solar Energy and applications	3	3	30	70	3 HRS
7B	Solar Energy and applications lab	3	2	25	25	3 HRS
SECPHY501 C	Applications of Electricity and Electronics	3	3	30	70	3 HRS
SECPHY501 P	Applications of Electricity and Electronics lab	3	2	25	25	3 HRS
SECPHY502 C	Electronic Instrumentation	3	3	30	70	3 HRS
SECPHY502 P	Electronic Instrumentation lab	3	2	25	25	3 HRS



**A. G & S.G. SIDDHARTHA DEGREE COLLEGE OF ARTS
& SCIENCE VUYYURU-521165.**
NAAC recredited at 'A' level
Autonomous -ISO 9001 – 2015 Certified

**Title of the Paper: MECHANICS, WAVES AND
OSCILLATIONS**

Course Type: Core (TH)

SEMESTER: I

Max.Time: 3 Hours

Course Code	PHYT11B	Course Delivery Method	Class Room / Blended Mode - Both
Credits	3	CIA Marks	30
No. of Lecture Hours / Week	4	Semester End Exam Marks	70
Total Number of Lecture Hours per semester	60	Total Marks	100
Year of Introduction: 2020-21	Year of Offering: 2021 -22	Year of Revision: 2021-22	Percentage of Revision: NIL
CLASS:	I B.Sc (MPC & MPCs)		

Course Prerequisites (if any):

To be eligible for BSc Physics admission, students need to graduate 10+2 with PCBM, or PCM as compulsory subjects.

Course Description:

The students would learn about the behaviour of physical bodies it provides the basic concepts related to the motion of all the objects around us in our daily life. The course builds a foundation of various applied field in science and technology; especially in the field of mechanical engineering. The course comprises of the study laws of motion, momentum, energy, rotational motion, gravitation, special relativity and study of superposition of harmonic oscillations, waves motion (general), oscillators, sound.

Course Objectives:

1. provide an in-depth understanding of the principles of Newtonian mechanics and apply them to solve problems involving the dynamic motion of classical mechanical systems
2. explain the limitations of Newtonian mechanics for motion at very high velocities, and thus introduce the special theory of relativity
3. provide hands-on experience to perform experiments to study some properties of matter and oscillations
4. By Learning Fourier analysis, student can analyse different mechanical, optical and electro-magnetic waves
5. To attain the knowledge of Ultrasonic waves and apply to different fields

Course outcomes:

On successful completion of this course, the students will be able to:

- CO1:** Remember the rotational kinematic relations and its applications such as freely rotating symmetric top. Comprehend the general characteristics of central forces and the application of Kepler's laws to describe the motion of planets and satellite in circular orbit through the study of law of Gravitation.
- CO2:** Understand Newton's laws of laws of motion, reference frames, and its applications i.e., projectile motion, Rocket motion.
- CO3:** Apply the rotational kinematic relations, the principle and working of gyroscope and its applications and the precessional motion of a freely rotating symmetric top.
- CO4:** Analyze the features of central forces with respect to planetary motion, waves and oscillations and formulate the problem of coupled oscillations and solve them to obtain normal modes of oscillation and their frequencies in simple mechanical systems.
- CO5:** Figure out the formation of harmonics and overtones in a stretched string and acquire knowledge on Ultrasonic waves, their production and detection and their applications in different fields.

SYLLABUS

Unit	Learning Units	Lecture Hours
I	<p>1.Mechanics of Particles (5 hrs) Review of Newton's Laws of Motion, Motion of variable mass system, Multistage rocket, Concept of impact parameter, scattering cross-section, Rutherford scattering-Derivation.</p> <p>2.Mechanics of Rigid bodies (7 hrs) Rigid body, rotational kinematic relations, Equation of motion for a rotating body, Angular momentum and Moment of inertia tensor, Euler equations, Precession of a spinning top, Gyroscope, Precession of the equinoxes</p>	12
II	<p>3.Celestial mechanics Central force - definition and examples, characteristics of central forces, conservative nature of central forces, Equation of motion under a central force</p> <p>4. Orbital mechanics Kepler's laws of planetary motion- Proofs, Motion of satellites – escape velocity, orbital velocity, Basic idea of Global Positioning System (GPS)</p>	12
III	<p>5.Frames of reference and transformation (5 hrs) Introduction to relativity, Frames of reference - Galilean transformations, absolute frames, Michelson-Morley experiment & negative result.</p> <p>6. Consequences of relativistic transformations (7 hrs) Postulates of Special theory of relativity, Lorentz transformation, time dilation, length contraction, variation of mass with velocity, Einstein's mass-energy relation</p>	12
IV	<p>7.Undamped, Damped and Forced oscillations: (07 hrs) Simple harmonic oscillator, damped harmonic oscillator, forced harmonic oscillator - differential equations and its solutions, Resonance, Logarithmic decrement, Relaxation time and Quality factor.</p> <p>8.Fourier analysis (05 hrs) Fourier theorem (Statement & limitations), evaluation of the Fourier coefficients using Fourier's theorem, analysis of periodic wave functions - square wave, triangular wave.</p>	12
V	<p>9.Vibrating Strings: (07 hrs) Transverse wave propagation along a stretched string, General solution of wave equation and its significance, Modes of vibration of stretched string clamped at ends, Overtones and Harmonics.</p> <p>10.Ultrasonics: (05 hrs) Ultrasonics, General Properties of ultrasonic waves, Production of ultrasonics by piezoelectric and magnetostriction methods, Detection of ultrasonics, Applications of ultrasonic waves, SONAR</p>	12

TEXT BOOKS

1. B. Sc. Physics, Vol.1, Telugu Academy, Hyderabad
2. Unified Physics - Waves and Oscillations, Jai PrakashNath&Co.Ltd.

REFERENCE BOOKS:

1. Fundamentals of Physics Vol. I - Resnick, Halliday, Krane, Wiley
2. College Physics-I. T. Bhimasankaram and G. Prasad. Himalaya Publishing House.
3. University Physics-FW Sears, MW Zemansky& HD Young, Narosa Publications, Delhi
4. Mechanics, S.G. Venkatachalapathy, Margham Publication, 2003. Waves and Oscillations. N. Subramanyam and Brijlal, VikasPulications
5. Waves & Oscillations. S. Badami, V. Balasubramanian and K.R. Reddy, Orient Longman.
6. The Physics of Waves and Oscillations, N.K. Bajaj, Tata McGraw Hill
7. Science and Technology of Ultrasonics- Baldevraj, Narosa, New Delhi,2004

STUDENT ACTIVITY

1. Seminars
2. Assignments.

LIBRARY ACTIVITY

Student visit library to refer and gather information regarding seminar topics and assignments.

Course Delivery method: Face-to-face / Blended

Course has focus on: Foundation & Employability



A.G & S.G Siddhartha Degree College of Arts and Science (Autonomous),
Vuyyuru - 521165

SEMESTER – I

MODEL PAPER (W.E.F 2022 – 2023)

Time : 3Hrs

Max.Marks:70M

Answer ALL the following questions, Choosing one question from (a) and one question from (b) in each question **(5x14 = 70M)**

1. A) i) What is Rutherford scattering? Obtain an expression for number of particles scattered per unit area. (CO1, L1)---- 10 M

(OR)

ii) What is precessional motion? Find angular velocity of precession of a spinning top. Show that the rate of precession is independent of mass but depends on the distribution of mass. (CO2, L1).----- 10M

B) i) State Newton's laws of motion and give two examples each. (CO1, L1)----4M

(OR)

ii) The kinetic energy of metal disc rotating at a constant speed of 5 revolutions per second is joules. Find the angular momentum of the disc. (CO2, L3)---- 4M

2. A) i) What is conservative force ? Show that central forces are conservative.(CO2, L2)----10 M

(OR)

ii) State Kepler's third law of motion. And prove that the square of period of revolution of a planet moving in a circular orbit round the sun is proportional to the cube of its distance from the sun. (CO2, L2)-----10 M

B) i) Explain central forces with examples. (CO2, L1)----- 4 M

(OR)

ii) If the Earth be one-half of its present distance from the sun, what will be the number of days in a year (CO2, L3)----- 4 M

3.A)i) State the fundamental postulates of special theory of relativity and deduce the Lorentz transformations. (CO3,L2)-----10 M

(OR)

ii) Describe the Michelson-Morley experiment and explain the physical significance of negative results. (CO3,L2)-----10 M

B) i) Explain time dilation. (CO3, L1) ----- 4 M



(OR)

ii) A rocket ship is 100 meter long on the ground when it is in flight, its length, is 99 meters to an observer on the ground. What is its speed?(CO3, L3) --- 4 M

4. A) i) What are damped oscillations? Derive the differential equation of damped Harmonic oscillator and discuss the case of under damping. (L2, CO3)---- 10 M

(OR)

ii) State Fourier Theorem and evaluate Fourier coefficients. (L2, CO4)---10 M

B) i) What is logarithmic decrement and relaxation time? (CO4, L1)---- 4 M

(OR)

ii) If the energy note of frequency 100Hz decreases to one half of tis original value in one second, calculate the Q-factor, (CO4, L3)----- 4 M

5. A) i)What are transverse waves? Obtain the equation of velocity of transverse wave in a wire kept under tension. (L3. CO5)----- 10 M

(OR)

ii) What are ultrasonics? Describe Magnetostriction method of producing ultrasonics (L3, CO5)-----10 M

B) i) Explain overtones and harmonics. (CO5, L1)-----4M

(OR)

ii) A piezoelectric crystal has a thickness of 0.002m. If the velocity of sound wave in crystal is 5750m/s, calculate the fundamental frequency of crystal. (CO5, L3)----4M

A. G & S.G. SIDDHARTHA DEGREE COLLEGE OF ARTS & SCIENCE VUYYURU-521165.

NAAC recredited at 'A' level
Autonomous -ISO 9001 – 2015 Certified

Title of the Paper: MECHANICS, WAVES AND OSCILLATIONS

Offered to: I B.Sc. (MPC&MPCs)

Course Type: Core (L)

Year of Introduction: 2020-21

Year of Revision: Nil

Percentage of Revision: Nil

Semester: I

Credits: 02

Hours Taught: 30 hrs. per Semester

Max. Time: 2 Hours

Course outcomes (Practicals):

On successful completion of this practical course, the student will be able to:

- CO 1.** Perform experiments on Properties of matter such as the determination of moduli of elasticity viz., Young's modulus, Rigidity modulus of certain materials; Surface tension of water, Coefficient of viscosity of a liquid, Moment of inertia of some regular bodies by different methods and compare the experimental values with the standard values.
- CO 2.** Know how to determine the acceleration due to gravity at a place using Compound pendulum and Simple pendulum.
- CO 3.** Notice the difference between flat resonance and sharp resonance in case of volume resonator and sonometer experiments respectively.
- CO 4.** Verify the laws of transverse vibrations in a stretched string using sonometer and comment on the relation between frequency, length and tension of a stretched string under vibration.

EXPERIMENTS LIST:

1. Young's modulus of the material of a bar (scale) by uniform bending
2. Young's modulus of the material a bar (scale) by non- uniform bending
3. Surface tension of a liquid by capillary rise method
4. Simple pendulum- normal distribution of errors-estimation of time period and the error of the mean by statistical analysis
5. Determination of 'g' by compound/bar pendulum
6. Verification of laws of vibrations of stretched string –Sonometer
7. Bifilar suspension –Moment of inertia of a regular rectangular body.
8. Rigidity modulus of material of a wire-Dynamic method (Torsional pendulum)
9. Volume resonator experiment
10. Viscosity of liquid by the flow method (Poiseuille's method)
11. Determination of the force constant of a spring by static and dynamic method. Coupled oscillators
12. Determination of frequency of a bar –Melde's experiment.

Note :

1. 9 (NINE) experiments are to be done and recorded in the lab. These experiments will be evaluated in CIA.
2. For certification minimum of 7 (Seven) experiments must be done and recorded by student who had put in 75 % of attendance in the lab.
3. **Best 6 experiments are to be considered for CIA.**
4. 10 marks for CIA.
5. 40 marks for practical exam.

The marks distribution for the Semester End practical examination is as follows:

Formula/ Principle / Statement with explanation of symbols	05
Diagram/Circuit Diagram / Tabular Columns	05
Setting up of the experiment and taking readings/Observations	10
Calculations (explicitly shown) + Graph + Result with Units	05
Procedure and precautions	05
Viva-voce	05
Record	05
Total Marks	40



A. G & S.G. SIDDHARTHA DEGREE COLLEGE OF ARTS & SCIENCE VUYYURU-521165.

NAAC recredited at 'A' level

Autonomous -ISO 9001 – 2015 Certified

Title of the Paper: HEAT AND THERMODYNAMICS

Course Type: Core (TH)

SEMESTER: III

Max.Time: 3 Hours

Course Code	PHYT31A	Course Delivery Method	Class Room / Blended Mode - Both
Credits	3	CIA Marks	25
No. of Lecture Hours / Week	4	Semester End Exam Marks	75
Total Number of Lecture Hours per semester	60	Total Marks	100
Year of Introduction: 2020-21	Year of Offering: 2021 -22	Year of Revision: 2021-22	Percentage of Revision: NIL
CLASS:	II B.Sc (MPC & MPCs)		

Course Description:

The course makes the students able to understand the basic physics of heat and temperature and their relation with energy, work, radiation and matter. The students also learn how laws of thermodynamics are used in a heat engine to transform heat into work. The course contains the study of laws of thermodynamics, thermodynamic description of systems, thermodynamic potentials, kinetic theory of gases.

Course Objectives:

1. Introduce the microscopic approach through kinetic theory of gases and basic statistical thermodynamics
2. Give the fundamentals of thermodynamic systems, the laws of thermodynamics and their application to thermodynamic problems
3. Provide essential tools to analyze Carnot engine, heat engines and refrigerators with the help of their thermodynamic cycles
4. Highlight the use of mathematical methods to derive thermodynamic relationships
5. Analyses thermal conductivity and black body radiation

COURSE OUTCOMES

Upon successful completion of this course, students should have the knowledge and skills to:

- CO1 State the First Law and define heat, work, thermal efficiency and the difference between various forms of energy and describe energy exchange processes, reversible and irreversible process.
- CO2 Understand the microscopic behavior of molecules, interactions and the concepts of transport phenomena of heat transfer, mass transfer and momentum transfer.
- CO3 Use kinetic theory of gases to derive expressions for pressure of an ideal gas, heat capacities of solids and gases and transport properties
- CO4 Understand very low temperatures like the concept of Joule Thomson effect, Liquefaction of gases and the properties at very low temperatures.
- CO5 Ability to evaluate entropy changes in a wide range of processes and determine the reversibility or irreversibility of a process from such calculations. Examine the nature of black body radiations and the basic theories.

SYLLABUS

Unit	Learning Units	Lecture Hours
I	<p>1. Kinetic Theory of gases-Introduction, Maxwell's law of distribution of molecular velocities, Mean free path, Degrees of freedom, Principle of equipartition of energy (Qualitative ideas only),</p> <p>2. Transport phenomenon in ideal gases: viscosity, Thermal conductivity and diffusion of gases.</p>	12
II	<p>3. Introduction to Thermodynamics Introduction- Isothermal and Adiabatic processes - Work done in these processes, Heat engines - Reversible and irreversible processes, Carnot's engine and its efficiency, Second law of thermodynamics, Carnot's theorem, Thermodynamic scale of temperature and its identity with perfect gas scale.</p> <p>4. Entropy Entropy and its Physical significance, change in entropy in reversible and irreversible processes; Entropy and disorder-Entropy of Universe; Temperature-Entropy (T-S) diagram and its uses, change of entropy when ice changes into steam (Qualitative).</p>	12
III	<p>5 Thermodynamic potentials - Internal Energy, Enthalpy, Helmholtz Free Energy, Gibb's Free Energy and their significance, Derivation of Maxwell's thermodynamic relations from thermodynamic potentials,</p> <p>6.Applications of Maxwell's thermodynamic relations: (i) Clausius-Clapeyron's equation (ii) Value of $C_p - C_v$ (iii) Value of C_p/C_v (iv) Joule-Kelvin coefficient for ideal and Van der Waals' gases</p>	12
IV	<p>Low temperature Physics: (12hrs)</p> <p>7. Methods for producing very low temperatures: Joule Kelvin effect - Porous plug experiment, Joule expansion, Distinction between adiabatic and Joule Thomson expansion, Expression for Joule Thomson cooling</p> <p>8. Production of low temperature: Adiabatic demagnetization, Principle of Refrigeration, effects of chloro and fluoro carbons on ozone layer.</p>	12
V	<p>9. Radiation Laws: (7 hrs) Blackbody and its spectral energy distribution of black body radiation, Kirchoff's law, Wein's displacement law, Stefan-Boltzmann's law and Rayleigh-Jean's law (No derivations), Planck's law of black body radiation-Derivation, Deduction of Wein's law and Rayleigh- Jean's law from Planck's law.</p> <p>10. Measurement of Radiation (5 hrs) Pyrometers: Angstrom pyrheliometer and determination Solar constant, Estimation of surface temperature of Sun.</p>	12

TEXT BOOKS

1. BSc Physics, Vol.2, Telugu Akademy, Hyderabad
2. Unified Physics Vol.2, Optics & Thermodynamics, Jai Prakash Nath &Co.Ltd., Meerut

REFERENCE BOOKS:

1. Thermodynamics, R.C. Srivastava, S.K. Saha & Abhay K. Jain, Eastern Economy Edition.
2. Fundamentals of Physics. Halliday/Resnick/Walker.C. Wiley India Edition 2007
3. Heat, Thermodynamics and Statistical Physics-N Brij Lal, P Subrahmanyam, P S Hemne, S. Chand& Co., 2012
4. Heat and Thermodynamics- MS Yadav, Anmol Publications Pvt. Ltd, 2000
5. University Physics, HD Young, MW Zemanski Sears, Narosa Publishers, New Delhi

STUDENT ACTIVITY

1. Seminars
2. Assignments.

LIBRARY ACTIVITY

Student visit library to refer and gather information regarding seminar topics and assignments.

Course Delivery method: Face-to-face / Blended

Course has focus on: Foundation & Employability



A.G & S.G Siddhartha Degree College of Arts and Science
(Autonomous), Vuyyuru - 521165

SEMESTER – III

Title of the Paper: Heat and Thermodynamics

MODEL PAPER (W.E.F 2022 – 2023)

Time : 3Hrs

Max.Marks : 75M

Section-A

Answer ALL questions :-

(5X10=50M)

1. a) Derive an expression for Maxwell's law of distribution of molecular speeds in a gas. (CO1, L1)

(OR)

b) Define coefficient of viscosity. On the basis of kinetic theory of gases, derive an expression for the coefficient of viscosity. (CO1, L1)

2. a) Describe the working of Carnot's reversible engine and derive an expression for its efficiency. (CO2, L2)

(OR)

b) What are reversible and irreversible processes? How does the entropy change in each of these processes? (CO2, L2)

3. a) Define the four thermodynamic potentials. Obtain Maxwell's thermodynamic equations using these potentials. (CO3, L3)

(OR)

b) State and explain Joule-kelvin effect. Obtain an expression for Joule-kelvin coefficient. (CO3, L3)

4. a) What is adiabatic demagnetization? How is this principle used in producing low temperatures? (CO3, L2)

(OR)

b) Explain Joule-kelvin effect. Derive an expression for Joule-Thompson cooling. (CO4, L2)

5. a) Derive the Planck's formula for the distribution of energy in black body radiation. (CO5, L2)

(OR)

b) What is a pyrometer? Describe the construction and working of Angstrom pyrliometer (CO5, L2)

Section-B

Answer any THREE of the following:

3X5=15M

6. Write a note mean free path. (CO1, L1)
7. Explain the second law of thermodynamics in terms of entropy. (CO2, L2)
8. Prove $C_p - C_v = R$ (CO3, L3)
9. Write the principle of refrigeration. (CO4, L3)
10. How did you find the solar constant. (CO5, L2)

Section-C

Answer any TWO of the following:

2X5=10M

11. Find the R.M.S velocity of hydrogen at N.T.P and at C° (CO1, L3)
12. Calculate the efficiency of a reversible engine that operates between the temperatures 200°C and 120°C ? (CO1, L3)
13. Calculate the temperature inversion of helium gas. Given $a=3.44 \times 10^{-3}\text{ntm}^4/\text{mol}^2$ and $b = 0.023 \times 10^{-3}\text{m}^3/\text{mol}$. (CO1, L3)
14. Find the wavelength at which maximum energy is radiated by a black at a temperature of 227°C and wien's constant is $2.877 \times 10^{-3}\text{mk}$. (CO1, L3)

**A. G & S.G. SIDDHARTHA DEGREE COLLEGE OF ARTS &
SCIENCE VUYYURU-521165.
NAAC recredited at 'A' level
Autonomous -ISO 9001 – 2015 Certified
Title of the Paper : HEAT AND THERMODYNAMICS (LAB)**

Offered to : II B.Sc (MPC&MPCs)

Course Type: Core (L) PHYP31A

Year of Introduction: 2020-21

Percentage of Revision: NIL

Semester: III

Hours Taught: 30 hrs. per Semester

Year of Revision: NIL

Credits: 02

Max. Time: 2 Hours

Course Description

Students would gain practical knowledge about heat and radiation, thermodynamics, thermo emf, RTD etc. and perform various experiments.

Course Objectives:

1. The primary objective of this course is to provide the fundamental knowledge to understand the behaviour of thermal systems.
2. This course provides a detailed necessary transfer through solids, fluids, and experimental analysis, including the application and heat vacuum.
3. Convection, conduction, and radiation heat transfer in one and two dimensional steady and unsteady systems are examined.

COURSE OUTCOMES

Upon successful completion of this course, students should have the knowledge and skills to:

- CO1: Determine the thermal conductivity of bad conductor-Lee's method, thermal conductivity of rubber and Coefficient of thermal conductivity of copper by using Searle's apparatus.
- CO2: Study the heating efficiency of electrical kettle with varying voltages.
- CO3: Determine Specific heat of a liquid by Joule's calorimeter and study Barton's radiation correction by plotting a graph between temperature and time and Specific heat of a liquid by applying Newton's law of cooling correction.
- CO4: Study temperature variation of resistance in a thermostat.

List of experiments

1. Study of variation of resistance with temperature - Thermistor.
2. Thermal conductivity of bad conductor-Lee's method
3. Thermal conductivity of rubber.
4. Measurement of Stefan's constant - emissive method

5. Heating efficiency of electrical kettle with varying voltages.
6. Specific heat of a liquid –Joule’s calorimeter –Barton’s radiation correction
7. Specific heat of a liquid by applying Newton’s law of cooling correction.
8. Thermo emf- thermo couple - Potentiometer
9. Thermal behavior of an electric bulb (filament/torch light bulb)
10. Measurement of Stefan’s constant

Note :

1. 9 (NINE) experiments are to be done and recorded in the lab. These experiments will be evaluated in CIA.
2. For certification minimum of 7 (Seven) experiments must be done and recorded by student who had put in 75 % of attendance in the lab.
3. **Best 6 experiments are to be considered for CIA.**
4. 10 marks for CIA.
5. 40 marks for practical exam.

The marks distribution for the Semester End practical examination is as follows:

Formula/ Principle / Statement with explanation of symbols	05
Diagram/Circuit Diagram / Tabular Columns	05
Setting up of the experiment and taking readings/Observations	10
Calculations (explicitly shown) + Graph + Result with Units	05
Procedure and precautions	05
Viva-voce	05
Record	05
Total Marks:	40

A. G & S.G. SIDDHARTHA DEGREE COLLEGE OF ARTS & SCIENCE,

VUYYURU-521165.



NAAC recredited at 'A' level
Autonomous -ISO 9001 – 2015 Certified
Title of the Paper: ELECTRICAL APPLIANCES

(AS PART OF SKILL DEVELOPMENT COURSES)

Semester: III

Course Code	SDCPHYT01	Course Delivery Method	Class Room / Blended Mode - Both
Credits	2	CIA Marks	10
No. of Lecture Hours / Week	2	Semester End Exam Marks	40
Total Number of Lecture Hours per semester	30	Total Marks	50
Year of Introduction: 2020-21	Year of Offering: 2021 -22	Year of Revision: -----	Percentage of Revision: NIL
CLASS :	II B.Sc		

Learning Outcomes:

By successful completion of the course, students will be able to:

- CO 1. Acquire necessary skills/hand on experience/ working knowledge on multimeters, galvanometers, ammeters, voltmeters, ac/dc generators, motors, transformers, single phase and three phase connections, basics of electrical wiring with electrical protection devices.
- CO2. Understand the working principles of different household domestic appliances.
- CO3. Check the electrical connections at house-hold but will also learn the skill to repair the electrical appliances for the general troubleshoots and wiring faults.

SYLLABUS

UNIT-I

(6 hrs)

Voltage, Current, Resistance, Capacitance, Inductance, Electrical conductors and Insulators, Ohm's law, Series and parallel combinations of resistors, Galvanometer, Ammeter, Voltmeter, Multimeter, Transformers, Electrical energy, Power, Kilowatt hour (kWh), consumption of electrical power .

UNIT-II

(10 hrs)

Direct current and alternating current, RMS and peak values, Power factor, Single phase and three phase connections , Basics of House wiring, Star and delta connection, Electric shock, First aid for electric shock, Overloading , Earthing and its necessity, Short circuiting , Fuses , MCB , ELCB, Insulation, Inverter, UPS .

UNIT-III

(10 hrs)

Principles of working, parts and servicing of Electric fan, Electric Iron box, Water heater; Induction heater, Microwave oven; Refrigerator, Concept of illumination, Electric bulbs, CFL, LED lights, Energy efficiency in electrical appliances, IS codes & IE codes.

Co-curricular Activities (Hands on Exercises): (04 hrs)

[Any four of the following may be taken up]

1. Studying the electrical performance and power consumption of a given number of bulbs connected in series and parallel circuits.
2. Measuring parameters in combinational DC circuits by applying Ohm's Law for different resistor values and voltage sources
3. Awareness of electrical safety tools and rescue of person in contact with live wire.
4. Checking the specific gravity of lead acid batteries in home UPS and topping-up with distilled water.
5. Identifying Phase, Neutral and Earth on power sockets.
6. Identifying primary and secondary windings and measuring primary and secondary voltages in various types of transformers.
7. Observing the working of transformer under no-load and full load conditions.
8. Observing the response of inductor and capacitor with DC and AC sources.
9. Observing the connections of elements and identify current flow and voltage drops.
10. Studying electrical circuit protection using MCBs, ELCBs
11. Assignments, Model exam etc.

Reference Books:

1. A Text book on Electrical Technology, B.L.Theraja, S.Chand& Co.
2. A Text book on Electrical Technology, A.K.Theraja.
3. Performance and design of AC machines, M.G.Say, ELBSEdn.,
4. Handbook of Repair & Maintenance of domestic electronics appliances; BPB Publications
5. Consumer Electronics, S.P.Bali, Pearson
6. Domestic Appliances Servicing, K.P.Anwer, Scholar Institute Publications

**A.G. & S.G.SIDDHARTHA DEGREE COLLEGE OF ARTS & SCIENCE
(AUTONOMOUS), VUYYURU.**

ACADEMIC YEAR-2022-23

SEMESTER – III	COURSE CODE : SDCPHYT01
PAPER TITLE : ELECTRICAL APPLIANCES	

Model Paper

Time: 2 Hours

Maximum marks : 40 M

Pass marks : 16M

SECTION-A

Answer any Two Questions . Each question carries 5 marks. (2X5=10Marks)__

1)

2)

3)

4)

SECTION-B

Answer any THREE Questions. Each question carries 10 marks. (3X10=30M)

5)

6)

7)

8)

9)

10)

The Guidelines to be followed by the question paper setters in PHYSICS for the
III-Semester - end exams. ACADEMIC YEAR-2022-23

Weightage for the question paper - ELECTRICAL APPLIANCES

syllabus	Section-A (Short answer questions)	Section-B (Essay questions)
Unit-1 (30Marks)	2	2
Unit-2 (25Marks)	1	2
Unit-3 (25Marks)	1	2

- Each Short answer question carries 5 marks in Section –A
- Each Essay question carries 10 marks in Section –B
- The Question papers setters are requested to cover all the topics in the syllabus stipulated as per the weightage given by us.



**A. G & S.G. SIDDHARTHA DEGREE COLLEGE OF ARTS &
SCIENCE , VUYYURU-521165.
NAAC recredited at 'A' level
Autonomous -ISO 9001 – 2015 Certified**

Title of the Paper: OPTICAL INSTRUMENTS AND OPTOMETRY

Semester: V/VI [Skill Enhancement Course (Elective)] Offered to: III B.Sc (MPC & MPCs)

Course Type: Core (TH)

Course Code	6A	Course Delivery Method	Class Room / Blended Mode
Credits	3	CIA Marks	30
No. of Lecture Hours / Week	3	Semester End Exam Marks	70
Total Number of Lecture Hours	45	Total Marks	100
Year of Introduction : 2022-23	Year of Offering: 2022-23	Year of Revision: -----	Percentage of Revision: 0

I. Learning Outcomes: Students at the successful completion of the course will be able to:

1. Understand the construction and working principles of various optical instruments used in daily life.
2. Acquire a critical knowledge on the various defects of eye and their correcting methods with suitable lenses.
3. Demonstrate skills of using biological microscope through hands on experience.
4. Understand the various techniques used in optometry and computer based eye testing.
5. Comprehend the various applications of microscopes and telescopes.

II. Syllabus: (Total Hours: 90 including Teaching, Lab, Field Training, Unit tests etc.)

UNIT-I OPTICAL MICROSCOPES (9hrs)

Introduction to Microscopes, Need of a Microscope, Different types of microscopes and their uses, Simple microscope-Construction, Magnifying power, normal adjustment; Compound microscope-Construction, Magnifying power, normal adjustment, Phase contrast microscope-Operating principle, Travelling microscope-Construction, working and uses

UNIT-II TELESCOPES (9hrs)

Introduction to Telescopes, Different types of Telescopes and their uses, Refracting Telescopes and Reflecting telescopes, Construction, working and magnifying power of Astronomical Telescope and Terrestrial Telescopes, Binoculars – working principle and applications.

UNIT-III APPLICATIONS OF OPTICAL INSTRUMENTS (9hrs)

Introductory ideas and applications of various microscopes viz., (i) Optical microscopes (Compound microscope, Stereo microscope, Confocal microscope) (ii) Electron microscopes (TEM, SEM), (iii) Scanning Probe microscope (iv) Scanning Acoustic microscope and (v) X-ray microscope.

Introductory ideas and applications of various telescopes viz., (i) Optical telescopes (ii) Radio telescopes (iii) Solar telescopes (iv) Infrared telescope (v) Ultraviolet telescope (vi) X-ray telescope and (vii) Gamma ray telescope

UNIT-IV OPTICAL VISION (9hrs)

Introduction to optical Vision, Eye as an optical instrument, Formation of image in the eye and the camera, Ophthalmic lenses, Power of the lenses, Far point and near points, Myopia and Hypermetropia defects, Removal of defects in vision using ophthalmic lenses, Contact lenses- Working principle, Different types of Contact lenses.

UNIT-V OPHTHALMIC TECHNIQUES AND OPTOMETRY (9hrs)

Ophthalmoscope and keratometer and their working principles, Evaluation of eye disorders, Guidelines for standardized eye chart preparation, Simple phoropter and its working principle and its uses, Checking the power of lenses, Principles of Computer based eye testing

References:

1. Optics and Optical Instruments: An Introduction by B. K. Johnson, Dover Publications.
2. Modern Optical Instruments and their construction by or ford Henry-Publisher: Biblio Life, LLC.
3. A Text Book of Optics by Brj Lal and N.Subramanyam, S.Chand& Co.
4. Practical Optics by Menn Naftly, Elsevier Science Publishing.
5. Applications of Optics in daily life | CK-12 Foundation. <https://flexbooks.ck12.org> ›
6. Web sources suggested by the teacher concerned and the college librarian including Reading material.

Course 6A: Optical Instruments and Optometry

PRACTICAL SYLLABUS (30 Hrs. Max Marks: 50)

IV. Learning Outcomes: On successful completion of this practical course, student shall be able to:

1. List out, identify and handle various equipments like binoculars, telescopes and microscopes.
2. Learn the procedures of operation of various optical instruments.
3. Demonstrate skills on testing the power of lenses, improving the resolution of telescopes and microscopes.
4. Acquire skills in observing and measuring the power, focal length and different refractive errors of eye.
5. Perform some techniques related to testing the blood and other biological samples.
6. Understand the technique of operation of Computer eye testing and evaluation.

V. Practical (Laboratory) Syllabus: (30 hrs)

1. Evaluation of magnifying power of simple microscope.
2. Measurement of reflection and transmission coefficient of certain materials using a microscope.
3. Resolving power of telescope
4. Determination of radii of different capillary tubes using travelling microscope.
5. Refractive index of a liquid (water) using (i) concave mirror and (ii) convex lens and a plane mirror.
6. Removal of refractive errors of eye using combination of lenses.
7. Determination of power of a convex lens by finding its focal length.

VI. Lab References:

1. A Practical Guide to Experimental Geometrical Optics by Yuriy A. Garbovskiy-Cambridge Univ. Press
2. <https://physics.columbia.edu/sites/default/files/content/Lab%20Resources/1292%20Lab%20Manual.pdf>
3. https://www.lnmiit.ac.in/Department/Physics/uploaded_files/lab-manual.pdf
4. Basic Optics Experiments -<http://www.phys.unm.edu> > Optics Lab > Basics
5. A Practical Guide to Experimental Geometrical Optics by Yuriy A. Garbovskiy, Anatoliy V. Glushchenko, Cambridge Univ. Press
6. Web sources suggested by the teacher concerned.
http://www.phy.olemiss.edu/~thomas/weblab/Optics_lab_Items/Telescope_Microscope

VII. Co-Curricular Activities

(a) Mandatory: (*Training of students by teacher in field related skills: (lab:10 + field: 05)*)

1. **For Teacher:** Training of students by the teacher (if necessary, by a local expert) in laboratory/field for a total of not less than 15 hours on the field techniques/skills on the familiarization of various optical instruments available in the laboratory; construction of different types of telescopes and their comparison in construction, operation and their utility and limitations; the details of construction of eye and various defects in the eye sight, emerging techniques in the design of eye lenses including contact lenses and making the student to understand on the testing of a biological sample using a clinical microscope

For Student: Students shall (individually) visit and observe the functioning of optical instruments at any one of the following places /centres like (a) pathological laboratory **or** (b) a local ophthalmologist **or** (c) a local optician to understand the various types of eye lenses **or** (d) a local computer based eye testing centre **or** (e) an optician, who fixes contact lenses **or** (f) a local cinema theatre **or** (g) a planetarium. Student shall write the observations and submit a hand-written Fieldwork/Project work not exceeding 10 pages in the given format to the teacher.

2. Max marks for Fieldwork/Project work: 05.

3. Suggested Format for Fieldwork/Project work: *Title page, student details, index page, details of place visited, observations, findings and acknowledgements.*

4. Unit tests (IE).

(b) Suggested Co-Curricular Activities

1. Training of students by related industrial experts.
2. Assignments (including technical assignments like identifying tools in the lens grinding, frame fitting, lens cleaning culture and other operational techniques with safety and security, IPR)
3. Seminars, Group discussions, Quiz, Debates etc. (on related topics).
4. Preparation of videos on tools and techniques in optical instruments and optical lenses, contact lenses.
5. Making a model microscope and measuring its magnification.
6. Making a simple astronomical telescope using two convex lenses.
7. Checking the power of your spectacles or lenses at home.
8. Students shall take up making their own (i) Telescope and (ii) Binoculars with the accessories available at home.

<https://paksc.org/pk/science-experiments/physics-experiments/how-to-make-astronomical-telescope>

<https://kids.nationalgeographic.com/nature/article/make-a-telescope>

<https://learning-center.homesciencetools.com/article/how-to-make-a-telescope-optical-science-project/>

<http://scipop.iucaa.in/Amateurs/telemaking.html>

9. Collection of material/figures/photos related to various types of lenses and their power.

10. Visit to any eye research laboratories, if available

11. Invited lectures and presentations on related topics by field/industrial experts

**The Guidelines to be followed by the question paper setters in PHYSICS for the
V/VI- Semester - end exams**

SEMESTER – V/VI	PAPER CODE : 6A
PAPER TITLE : OPTICAL INSTRUMENTS AND OPTOMETRY ACADEMIC YEAR-2022-2023	

Weightage for the question paper :

syllabus	Section-A (Short answer questions)	Section-B (essay questions)
Unit-1 (20 Marks)	2	1
Unit-2 (25Marks)	1	2
Unit-3 (25Marks)	2	1
Unit-4 (30Marks)	2	2
Unit-5 (15 Marks)	1	2

- Each Short answer question carries 5 marks in Section –A
- Each Essay question carries 10 marks in Section –B
- The Question papers setters are requested to cover all the topics in the syllabus stipulated as per the weightage given by us.



& S.G.SIDDHARTHA DEGREE COLLEGE OF ARTS & SCIENCE

(AUTONOMOUS), VUYYURU.

(Accredited at "A" Grade by NAAC, Bangalore)

**III B.Sc, PHYSICS
SEMESTER – V/VI**

PAPER CODE : 6A

PAPER TITLE : OPTICAL INSTRUMENTS AND OPTOMETRY

Paper : 6 A

ACADEMIC YEAR-2022-2023

Time: 3Hours

Maximum marks: 70

Minimum marks: 28

MODEL PAPER

Section - A

Answer any **Four** of the following :-

(4X5=20M)

1. What are the uses of travelling microscope .
2. Explain the need of microscope.
3. Explain the principle of Astronomical telescope.
4. Write any five uses of telescope.
5. Explain the principle of X-ray microscope.
6. Explain the principle of Ultraviolet telescope.
7. Distinguish between Myopia and Hypermetropia defects.
8. How to check the power of lenses? Explain.

Section - B

Answer any **Five** of the following :-

(5X10=50M)

9. Briefly explain the different types of microscopes.
10. Explain the construction and working of travelling microscope.
11. Explain about Refracting and Reflecting telescopes.
12. Explain working principle of Binoculars. Write the applications.
13. Write a short note on Electron microscopes (TEM, SEM).
14. Discuss the applications of various telescopes.
15. Whatdo you mean by optical Vision ? Explain the formation of image in the eye and the camera.
16. Explain the working principles of ophthalmoscope and keratometer.

**A. G & S.G. SIDDHARTHA DEGREE COLLEGE OF ARTS &
SCIENCE VUYURU-521165.
NAAC recredited at 'A' level
Autonomous -ISO 9001 – 2015 Certified**

**Title of the Paper : Course 7A: OPTICAL IMAGING AND PHOTOGRAPHY_
Semester: V/VI**

[Skill Enhancement Course (Elective)] Offered to : III B.Sc (MPC & MPCs) Course Type: Core (TH)

Course Code	7A	Course Delivery Method	Class Room / Blended Mode
Credits	3	CIA Marks	30
No. of Lecture Hours / Week	3	Semester End Exam Marks	70
Total Number of Lecture Hours	45	Total Marks	100
Year of Introduction : 2022-23	Year of Offering: 2022-23	Year of Revision: -----	Percentage of Revision: -----

I. Learning Outcomes: Students after successful completion of the course will be able to:

1. Identify the different types of cameras and camera lenses according to different purposes.
2. Identify and understand the focal length of the different types of lenses
3. Acquire a critical knowledge on natural and artificial sources of light and their application in photography.
4. Demonstrate skills of camera usage especially Digital Cameras.
5. Understand the various Image development and editing techniques.
6. Comprehend the concept of different types of common shooting techniques.

II. Syllabus: (Total Hours: 90 including Teaching, Lab, Field Training, Unit tests etc.)

Unit-I : INTRODUCTION TO PHOTOGRAPHY: (9 hrs)

Photography-Introduction, working principle of a camera, Image formation in simple camera and human eye, Types of cameras, Pin-hole camera, Single Lens Reflex (SLR) camera, Twin Lens Reflex (TLR) camera, Digital Single-lens reflex camera (DSLR), Digital camera, Drone flying cameras, Care and maintenance of camera, Factors influencing choice of camera

Unit-II : DIGITAL PHOTOGRAPHY: (9 hrs)

Different types of Digital cameras and their parts, Working of DSLR camera, Types of lenses- Normal, Wide angle, telephoto, Zoom lenses, Digital Image formation, Digital camera image sensors, Size of the image, Depth of focus, Depth of field, Exposure time, Aperture, Shutter speed, ISO, filters, knowledge on pixels and their uses , resolution, Camera accessories

Unit-III : PHOTOGRAPHIC LIGHT SOURCES: (9 hrs)

Need for the light in photography, Light sources- Natural light, Sun light, Moon light, Ambient light, Artificial light sources-Flood light, Spot light, Halogen light, Halogen flash light, Digital lights, Exposure, Studio photography

Unit-IV : PHOTOGRAPHIC SHOOTING TECHNIQUES: (9 hrs)

Significance and role of Camera lens in photo shooting, Arrangement of lenses in a Camera- Positioning, Techniques involved in the use of DSLR cameras, Usage of Filters, Techniques of Photomicrography, High speed Photography with motor driven camera, Basic ideas on Underwater Photography, Medical Photography, Astronomical Photography, Infra-Red (IR) Photography, Ultra Violet (UV) Photography and Forensic Photography.

Unit-V : PHOTO MANIPULATION :(9 hrs)

Developing and printing the photographs, equipment and materials used in developing and printing, image mixing and printing, Image editing through image editing software's like Adobe Photoshop – Adjustment of Brightness, Contrast, Tonal and Colour Values, Factors influencing quality of digital image, Methods of storing and processing, Image transportation through Pendrive, CD, HDD and CLOUD [Internet]

III Reference Books:

1. Object and image; An introduction to photography by George M Craven, PHI
2. An Introduction to Digital Photo Imaging Agfa, 1994
3. Advance Photography by M. Langford.
4. Digital Photography-A hands on Introduction by Phillip Krejcarek, Delmer Publishers
5. Multimedia – An Introduction by John Villamil, PHI
6. <https://www.adobe.com/in/creativecloud/photography/discover/dslr-camera.html>
7. Web sources suggested by the teacher concerned and the college librarian including reading material.

Course 7A: Optical Imaging and Photography

PRACTICAL SYLLABUS (30 Hrs, Max Marks: 50)

IV. Learning Outcomes: On successful completion of this practical course, student shall be able to:

1. List out, identify and understand various image formation techniques including Eye.
2. Learn the procedures of using Analog and Digital cameras.
3. Demonstrate the focusing techniques of Analog and Digital cameras.
4. Acquire skills in the editing and development of photos and videos.
5. Perform some experimental skills related to images, videos using the equipment available in the lab or in a local studio.

V. Practical (Laboratory) Syllabus: (30 hrs)

1. Construction of a simple pin hole Camera and study it's working.
2. Capture an image using a Digital Camera and apply editing techniques.
3. Understanding various image formats and convert one image format into other (For ex: JPEG to BMP)
4. Convert a video stream into image stream by using a suitable editing software.
5. Evaluate the number of pixels and size of digital Image.
6. Comparison of the quality of a 8-bit, 16-bit and 32 bit images.
7. Perform the reduction and enlargement of a given Digital Image.
8. Change the appearance of an image by applying the filters (For ex: from the IR image of the given digital Image by suitable IR filter)

VI. Lab References:

1. DSLR Photography for Beginners by Brian Black
2. The Art of Photography by Bruce Barnbaum
3. Photoshop for Photographers by John Slavio
4. <https://www.youtube.com/channel/UCwWyFRy2l6aUFMsRemP51Sw>. You Tube resource.
5. <https://www.udemy.com/course/complete-photography-course/>
6. Web sources suggested by the teacher concerned.

VII. Co-Curricular Activities

(a) Mandatory: (*Training of students by teacher in field related skills: (lab:10 + field: 05)*):

1. For Teacher: Training of students by the teacher (if necessary, by a local expert) in laboratory/field for not less than 15 hours on the field techniques/skills of Image formation by using lenses and mirrors. Also to make students to understand the construction, operation and the Physics principles involved in a normal Camera and Digital Camera.

2. For Student: Students shall (individually) visit a local Photo studio or any such facility in a university/research organization/private and observe (i) the operation of different digital cameras, compact and SLR and in taking photographs using different types of lenses by varying aperture, shutter speed for still camera, video camera, CCTV and spy camera **or** (ii) the use of natural light, tungsten light, fluorescent light, electronic flash reflectors, exposure meters, studio flash and its accessories **or** (iii) the usage of various lighting techniques for different lenses and will do practice on special areas of photography in outdoor and indoor conditions **or** (iv) the different processes viz., audio video recording, mixing, editing, dubbing of sound, using different types of microphones **or** (v) the handling of the digital video cameras, DVD, HDD, accessories and exposure to take different common shots, dimension of images and movements as per requirement **or** (vi) the computer system by digital editing software, printing the photographs taken by digital cameras and the image transportation to the storage media, sending photographs through E-mail and Scanning the photographs, capture frames and analysis of images and record their observations and submit a hand-written Fieldwork/Project work not exceeding 10 pages in the given format to the teacher.

3. Max marks for Fieldwork/Project work: 05.

4. Suggested Format for Fieldwork/Project work: *Title page, student details, index page, details of place visited, observations, findings and acknowledgements.*

5. Tests (IE).

(b) Suggested Co-Curricular Activities:

1. Training of students by a related skilled person from a Photo studio.

2. Assignments (including technical assignments like identifying the tools & techniques involved in photography and handling, operational techniques of different Cameras with safety and security)

3. Seminars, Group discussions, Quiz, Debates etc. (on related topics).

4. Preparation of videos on tools and techniques related to Image formation and Photographic Techniques.

5. Practice taking outdoor photographs with a digital camera in (i) Black & White and (ii) Colour in the following conditions:

Landscapes – Street / Building – Sculpture – Insect / Animal movement – Industrial plant (outside view) – Children, birds (close up / long shot / model photography)- slow and fast moving objects-Night photography etc.

6. Shooting of different areas and topics such as sports, wildlife, modeling, drama, documentary, serial, story board making, news, interview, seminar/ workshop, industrial, live broadcasting, musical event, advertisement, etc.

7. Collection of material/figures/photos related to various components of a Camera, writing and organizing them in a systematic way in a file.

8. Visits to any local Photo Studio or any Lab in universities, research organizations, private firms, etc.

9. Invited lectures and presentations on related topics by field/industrial experts.

**The Guidelines to be followed by the question paper setters in PHYSICS for the
V/VI- Semester - end exams**

SEMESTER – V/VI	PAPER CODE : 7A
PAPER TITLE : OPTICAL IMAGING AND PHOTOGRAPHY ACADEMIC YEAR-2022-2023	

Weightage for the question paper :

syllabus	Section-A (Short answer questions)	Section-B (essay questions)
Unit-1 (20 Marks)	2	1
Unit-2 (25Marks)	1	2
Unit-3 (25Marks)	2	1
Unit-4 (30Marks)	2	2
Unit-5 (15 Marks)	1	2

- Each Short answer question carries 5 marks in Section –A
- Each Essay question carries 10 marks in Section –B
- The Question papers setters are requested to cover all the topics in the syllabus stipulated as per the weightage given by us.

**A.G. & S.G.SIDDHARTHA DEGREE COLLEGE OF ARTS & SCIENCE
(AUTONOMOUS), VUYYURU.**

(Accredited at "A" Grade by NAAC, Bangalore)

III B.Sc ,PHYSICS , SEMESTER – V /VI	PAPER CODE : 7A
PAPER TITLE : OPTICAL IMAGING AND PHOTOGRAPHY Paper : 7 A ACADEMIC YEAR-2022-2023	

Time: 3Hours

Maximum marks: 70

Minimum marks: 28

MODEL PAPER
Section A

Answer any **Four** of the following

(4X5=20M)

1. Explain about drone flying camera.
2. Write a short note on factors influencing choice of camera.
3. Explain the procedure of digital image formation.
4. What do you mean by ISO? Explain.
5. What do you mean by studio photography.
6. Explain the significance and role of camera lens in photo shooting.
7. Explain image transportation through pendrive.
8. How photographs are developed and printed?

Section – B

Answer any **Five** of the following :-

(5X10=50 M)___

9. Explain the working principle of a camera. Mention different types of cameras.
10. Briefly explain Twin Lens Reflex (TLR) camera, Digital Single-lens reflex camera (DSLR).
11. Explain different types of digital cameras and their parts.
12. Give a brief account on pixels and write their uses.
13. What is light? Explain various light sources used in photography.
14. Discuss about different artificial light sources.
15. Write a note on techniques involved in the use of DSLR cameras.
16. Explain the procedure of image editing through Adobe photoshop software.



**A. G & S.G. SIDDHARTHA DEGREE COLLEGE OF ARTS &
SCIENCE VUYYURU-521165.**
NAAC recredited at 'A' level
Autonomous -ISO 9001 – 2015 Certified

Title of the Paper : Low Temperature Physics & Refrigeration
Semester: V/VI

[Skill Enhancement Course (Elective)] Offered to : III B.Sc (MPC & MPCs) Course Type: Core (TH)

Course Code	6B	Course Delivery Method	Class Room / Blended Mode
Credits	3	CIA Marks	30
No. of Lecture Hours / Week	3	Semester End Exam Marks	70
Total Number of Lecture Hours	45	Total Marks	100
Year of Introduction : 2022-23	Year of Offering: 2022-23	Year of Revision: -----	Percentage of Revision: -----

Course Objectives:

1. To acquire the knowledge of producing refrigerating effect or cooling which is used in air refrigeration cycles.
2. To understand the different methods of producing low temperatures & necessity of low temperature in various fields.
3. To know the techniques of measuring low temperatures by using various thermometers with accuracy and to estimate the internal energy possessed by the system.
4. Gives the idea on Methodology involved in both refrigeration cycle, network of refrigerated components to understand the transient simulations of whole system.
5. To acquire the knowledge on benefits of Cryogenics in various fields like Preservation of biological material & food, Macroscopic quantum phenomena, Cryo surgery, Medical field, Data centers, and Satellites

Course Outcomes: Students after successful completion of the course will be able to

1. Identify various methods and techniques used to produce low temperatures in the Laboratory.
2. Acquire a critical knowledge on refrigeration and air conditioning.
3. Demonstrate skills of Refrigerators through hands on experience and learns about refrigeration components and their accessories.
4. Understand the classification, properties of refrigerants and their effects on environment.
5. Comprehend the applications of Low Temperature Physics and refrigeration.

Syllabus : -

UNIT-I PRODUCTION OF LOW TEMPERATURE (9 hrs)

- (a) Production of low temperatures-Introduction, Freezing mixtures, Joule-Thomson effect (concept only), Regenerative cooling,
- (b) Different methods of liquefaction of gases, liquefaction of air, Production of liquid hydrogen and nitrogen, Adiabatic demagnetization, Properties of materials at low temperatures. Superconductivity

UNIT-II MEASUREMENT OF LOW TEMPERATURE (9 hrs)

- (a) Gas thermometer and its correction and calibration, Secondary thermometers, resistance thermometers, thermocouples.
- (b) Vapour pressure thermometers, Magnetic thermometers, Advantages and drawbacks of each type of thermometer.

UNIT-III PRINCIPLES OF REFRIGERATION (9 hrs)

- (a) Introduction to Refrigeration- Natural and artificial refrigeration, Stages of refrigeration, Types of refrigeration - Vapor compression and vapor absorption refrigeration systems, Refrigeration cycle and explanation with a block diagram, Introductory ideas on air- conditioning.
- (b) Refrigerants-Introduction, Ideal refrigerant, Properties of refrigerant, Classification of refrigerants, commonly used refrigerants, Eco-friendly refrigerants

UNIT-IV COMPONENTS OF REFRIGERATOR (9 hrs)

- (a) Refrigerator and its working, Block diagram, Coefficient of Performance (COP), Tons of refrigeration (TR) and Energy Efficiency Ratio (EER)
- (b) Refrigerator components: Types of compressors, evaporators and condensers and their functional aspects, defrosting in a refrigerator, Refrigerant leakage and detection

UNIT-V: APPLICATIONS OF LOW TEMPERATURE & REFRIGERATION (9 hrs.)

- (a) Applications of Low temperatures: Preservation of biological material, Food freezing, liquid nitrogen and liquid hydrogen in medical field, Superconducting magnets in MRI- Tissue ablation (cryosurgery) - Cryogenic rocket propulsion system.
- (b) Applications of refrigeration: Domestic refrigerators, Water coolers, Cold treatment of metals, Construction field, Cold storages, Ice plants, Food preservation methods, Chemical and Process industries, Desalination of water, Data centers (Field visit and it's report).

References:

1. Heat and Thermodynamics by Brij Lal & N. Subramanyam, S. Chand Publishers.
2. Thermal Physics by S C Garg, R M Bansal & C K Ghosh, McGrawHill Education, India
3. Heat and Thermodynamics by M Zemansky, McGrawHill Education (India).
4. Low-Temperature Physics by Christian E. & Siegfried H., Springer.
5. Thermal Engineering by S. Singh, S. Pati, Ch:18 Introduction to Refrigeration.
6. The Physics Hyper Text Book. Refrigerators. <https://physics.info/refrigerators/>
7. Refrigeration and Air Conditioning by Manohar Prasad, New age international (P)limited, New Delhi
8. A course in Refrigeration and Air Conditioning by S.C. Arora and S. Domkundwar, Dhanpatrai and sons, Delhi
9. https://trc.nist.gov/cryogenics/Papers/Review/2017-Low_Temperature_Applications_and_Challenges.pdf
10. <https://nptel.ac.in/content/storage2/courses/112105129/pdf/RAC%20Lecture%203.pdf>
11. Other Web sources suggested by the teacher concerned and the reading material. <https://nptel.ac.in>

**A. G & S.G. SIDDHARTHA DEGREE COLLEGE OF ARTS &
SCIENCE VUYYURU-521165.
NAAC recredited at 'A' level
*Autonomous -ISO 9001 – 2015 Certified***

PHYSICS	Semester – V/VI	2022-2023	B.Sc. (MPC&MPCs)
----------------	------------------------	------------------	-----------------------------

Credits – 2

TITLE : 6B : Low Temperature Physics & Refrigeration Lab

Learning Outcomes: On completion of practical course, student shall be able to

1. List out, identify and handle equipment used in refrigeration and low temperature lab.
2. Learn the procedures of preparation of Freezing Mixtures.
3. Demonstrate skills on developing various Freezing mixtures and materials and their applications in agriculture, medicine and day to day life.
4. Acquire skills in observing and measuring various methodologies of very low temperatures
- b. Perform some techniques related to Refrigeration and Freezing in daily life.

Practical (Laboratory) Syllabus: (*Max marks: 50*)

1. Record the Principles and applications of Refrigerators and Freezers.
2. Measure the temperatures below Melting point of Ice using a thermometer available in the Lab.
3. Make a freezing mixture by adding different salts viz., Sodium chloride, Potassium Hydrate (KOH), Calcium chloride to ice in different proportions and observe the temperature changes.
4. Study the operation of a refrigerator and understand the working of different parts.
5. Study the properties of refrigerants like chlorofluorocarbons- hydrochlorofluoro- carbons and record the lowest temperatures obtained.
6. Consider a simple faulty refrigerator and try to troubleshoot the simple problems by understanding its working.
7. Understand the practical problem of filling the Freon Gas into the Refrigerator.
8. Get the Liquid Nitrogen or Liquid Helium from nearby Veterinary Hospital and measure their temperatures using chromel-alumel thermocouple or mercury thermometer and observe their physical properties like colour, smell etc and precautions to be taken for their safe handling.
9. Preparation of freeze drying food with Dry ice and liquid nitrogen
10. Preparation of freeze drying food with liquid nitrogen

**The Guidelines to be followed by the question paper setters in PHYSICS for the
V/VI- Semester - end exams**

SEMESTER – V/VI	PAPER CODE : 6B
PAPER TITLE : Low Temperature Physics & Refrigeration ACADEMIC YEAR-2022-2023	

Weightage for the question paper :

syllabus	Section-A (Short answer questions)	Section-B (essay questions)
Unit-1 (20 Marks)	2	1
Unit-2 (25Marks)	1	2
Unit-3 (25Marks)	2	1
Unit-4 (30Marks)	2	2
Unit-5 (15 Marks)	1	2

- Each Short answer question carries 5 marks in Section –A
- Each Essay question carries 10 marks in Section –B
- The Question papers setters are requested to cover all the topics in the syllabus stipulated as per the weightage given by us.



**A.G. & S.G.SIDDHARTHA DEGREE COLLEGE OF ARTS &
SCIENCE (AUTONOMOUS), VUYYURU.**

(Accredited at "A" Grade by NAAC, Bangalore)

III B.Sc PHYSICS , SEMESTER – V/VI	PAPER CODE : 6B
PAPER TITLE : LOW TEMPERATURE PHYSICS & REFRIGERATION	
ACADEMIC YEAR-2022-2023	

Time: 3Hours

Maximum marks: 70

Minimum marks: 28

MODEL PAPER

Section A

Answer any **Four** of the following

(4X5=20M)

1. Explain Joule Thomson effect. L2, CO1
2. Explain the properties of materials at low temperatures.L2, CO1
3. Write about Resistance thermometer. L1, CO2
4. Explain the advantages and drawbacks of magnetic thermometers. L2, CO2
5. Explain briefly refrigeration by vapor absorption method. L2, CO3
6. What is an ideal refrigerant?L1,CO3.
7. Explain the term Energy Efficiency ratio. L1, CO4
8. Explain the working of water coolers. L3, CO5

Section -B

Answer any **FIVE** of the following

(5X10=50M)

9. Explain the liquefaction of Air with neat diagram. L2, CO1
10. Explain the production of low temperatures by adiabatic demagnetization method . L2, CO-1
11. Explain about gas thermometers and their calibration. L3, CO2
12. Explain vapour pressure thermometer. L3, CO2
13. Explain Natural and artificial refrigeration & various stages involved in refrigeration L2, CO3
14. Explain various types of refrigerants and their properties. L2, CO3 .
15. Explain the principle & working of refrigerator with block diagram L3, CO4
- 16 . Explain the applications of low temperatures in various fields. L3,CO5.



**A. G & S.G. SIDDHARTHA DEGREE COLLEGE OF ARTS &
SCIENCE VUYYURU-521165.**
NAAC re accredited at 'A' level
Autonomous -ISO 9001 – 2015 Certified

Title of the Paper : 7 B : Solar Energy and Applications, Semester: V/VI

[Skill Enhancement Course (Elective)] Offered to : III B.Sc (MPC & MPCs) Course Type: Core (TH)

Course Code	7B	Course Delivery Method	Class Room / Blended Mode
Credits	3	CIA Marks	30
No. of Lecture Hours / Week	3	Semester End Exam Marks	70
Total Number of Lecture Hours	45	Total Marks	100
Year of Introduction : 2022-23	Year of Offering: 2022-23	Year of Revision: -----	Percentage of Revision: -----

Course Objectives:

1. Acquire knowledge on solar radiation principles with respect to solar energy estimation.
2. Get familiarized with various collecting techniques of solar energy and its storage
3. Learn the solar photovoltaic technology principles and different types of solar cells for energy conversion and different photovoltaic applications.

Course Outcomes:

After successful completion of the course, the student will be able to:

1. Understand Sun structure, forms of energy coming from the Sun and its measurement.
2. Acquire a critical knowledge on the working of thermal and photo voltaic collectors.
3. Understand testing procedures and fault analysis of thermal collectors and PV modules.
4. Comprehend applications of thermal collectors and PV modules.

Syllabus:

Unit-I: BASIC CONCEPTS OF SOLAR ENERGY

(a) Spectral distribution of solar radiation, Solar constant, zenith angle and Air-Mass, standard time, local apparent time, equation of time, direct, diffuse and total radiations.

(b) Pyroheliometer-working principle, direct radiation measurement, Pyrometer-working principle, diffuse radiation measurement, Distinction between the two meters.

Unit-II: SOLAR THERMAL COLLECTORS(10hrs)

(a) Solar Thermal Collectors-Introduction, Types of Thermal collectors, Flat plate collector – liquid heating type, Energy balance equation and efficiency, Evacuated tube collector, collector or overall heat loss coefficient.

(b) Definitions of collector efficiency factor, collector heat-removal factor and collector flow factor, Testing of flat-plate collector, solar water heating system, natural and forced circulation types. Concentrating collectors, Solar cookers, Solar dryers, Solar declinators.

Unit-III : FUNDAMENTALS OF SOLAR CELLS (10hrs)

(a) Semi conductor interface, Types, homo junction, hetero junction and Schottky barrier, advantages and drawbacks, Photo voltaic cell, equivalent circuit, output parameters (Field Visit and its report), conversion efficiency, quantum efficiency

(b) Measurement of IV characteristics, series and shunt resistance, their effect on efficiency, Effect of light intensity, inclination and temperature on efficiency

Unit-IV: TYPES OF SOLAR CELLS AND MODULES(10hrs)

(a) Types of solar cells, Crystalline silicon solar cells, I-V characteristics, poly-Si cells, Amorphous silicon cells, Thin film solar cells- CdTe/CdS and CuInGaSe₂/CdS cell configurations, structures, advantages and limitations

(b) Multi junction cells – Double and triple junction cells. Module fabrication steps, Modules in series and parallel, Bypass and blocking diodes.

Unit-V: SOLAR PHOTOVOLTAIC SYSTEMS(10hrs)

(a) Energy storage in PV systems, Energy storage modes, electrochemical storage, Batteries, Primary and secondary.

(b) Solid-state battery, Molten solvent battery, lead acid battery and dry batteries, Mechanical storage –Flywheel, Electrical storage –Super capacitor

References:

1. Solar Energy Utilization by G. D. Rai, Khanna Publishers
2. Solar Energy- Fundamentals, design, modelling and applications by G.N. Tiwari, Narosa Publications, 2005.
3. Solar Energy-Principles of thermal energy collection & storage by S.P. Sukhatme, TataMc-GrawHill Publishers, 1999.
4. Science and Technology of Photo voltaics, P. Jayarama Reddy, CRC Press(Taylor &Francis Group), Leiden &BS Publications,Hyderabad,2009.
5. Solar Photo voltaics-Fundamentals, technologies and applications, Chetan Singh Solanki, PHI Learning Pvt. Ltd.,
- 6.

Websources suggested by the teacher concerned and the college librarian including reading material.

(a) https://courses.edx.org/c4x/DelftX/ET.3034TU/asset/solar_energy_v1.1.pdf

(b) <https://www.sku.ac.ir/Datafiles/BookLibrary/45/John%20A.%20Duffie,%20>

Solar Energy and Applications – Practical (lab)work (MaxMarks:50)

Learning Outcomes: On successful completion of this practical course, student shall be able to:

1. List out and identify various components of solar thermal collectors and systems, solar photo voltaic modules and systems.
2. Learn the procedures for measurement of direct, global and diffuse solar radiation, I-V characteristics and efficiency analysis of solar cells and modules.
- 3.

Demonstrates skills acquired in evaluating the performance of solar cell/module in connecting them appropriately to get required power output.

4. Acquire skills in identification and elimination of the damaged panels without affecting the output power in a module / array.
- 5.

Perform procedures and techniques related to general maintenance of solar thermal and photo voltaic modules.

I. Practical(Laboratory) Syllabus: (30hrs)(Max.50Marks)

1. Measurement of direct radiation using pyrheliometer.
2. Measurement of global and diffuse radiation using pyranometer.
3. Evaluation of performance of a flat plate collector
4. Evaluation of solar cell / module efficiency by studying the I –V measurements.
5. Determination of series and shunt resistance of a solar cell/module.
6. Determination of efficiency of two solar cells/ modules connected in series.
7. Determination of efficiency of two solar cells/ modules connected in parallel.
8. Study the effect of input intensity on the performance of solar cell / module.
9. Study the influence of cell /module temperature on the efficiency.
10. Study the effect of cell / module inclination on the efficiency.

**The Guidelines to be followed by the question paper setters in PHYSICS for the
V/VI- Semester - end exams**

SEMESTER – V/VI	PAPER CODE : 7B
PAPER TITLE : Solar Energy and Applications ACADEMIC YEAR-2022-2023	

Weightage for the question paper :

syllabus	Section-A (Short answer questions)	Section-B (essay questions)
Unit-1 (20 Marks)	2	1
Unit-2 (25Marks)	1	2
Unit-3 (25Marks)	2	1
Unit-4 (30Marks)	2	2
Unit-5 (15 Marks)	1	2

- Each Short answer question carries 5 marks in Section –A
- Each Essay question carries 10 marks in Section –B
- The Question papers setters are requested to cover all the topics in the syllabus stipulated as per the weightage given by us.



**A.G. & S.G.SIDDHARTHA DEGREE COLLEGE OF ARTS & SCIENCE
(AUTONOMOUS), VUYYURU.**

(Accredited at "A" Grade by NAAC, Bangalore)

III B.Sc , PHYSICS SEMESTER – V/VI	PAPER CODE : 7B
PAPER TITLE : SOLAR ENERGY AND APPLICATIONS	
ACADEMIC YEAR-2022-2023	

Time: 3Hours

Maximum marks: 70

Minimum marks: 28

MODEL PAPER

Section - A

Answer any Four of the following

(4X5=20M)

1. Distinguish direct and diffuse radiations. L2, CO1
2. How can you measure direct radiation? L3, CO1
3. What is collector heat removal factor and collector flow factor ? L3, CO2
4. Explain Testing of Flat Plate Collector . L1, CO2
5. What is schottky barrier? L1, CO3
6. Explain about I-V characteristics of solar cell. L1, CO3
7. Explain Advantages and Limitations of solar cells. L3, CO4
8. Write about super capacitor. L1, CO5

Section - B

Answer any FIVE of the following

(5X10=50M)

9. Explain spectral distribution of solar radiation. L1, CO1
10. Describe the working of pyroheliometer. L1, CO1
11. Write about Flat plate collector and its efficiency. L1, CO2
12. What are the types of solar water heating system? Explain natural circulation type. L2, CO2
13. Define homo junction and hetero junction. What are the advantages and drawbacks? L2, CO3
14. Explain the effect of light intensity, inclination and temperature on efficiency of PVcell. L1, CO3
15. What are the types of solar cells? Write about CdTe/Cds solar cell. L2, CO4
16. Write about various energy storage modes. L2, CO5



A. G & S.G. SIDDHARTHA DEGREE COLLEGE OF ARTS & SCIENCE VUYYURU-521165.

NAAC reaccruited at 'A' level

Autonomous -ISO 9001 – 2015 Certified

Domain Subject: PHYSICS

Title of the Paper : APPLICATIONS OF ELECTRICITY & ELECTRONICS Semester: V/VI

[Skill Enhancement Course (Elective)] Offered to : III B.Sc (MPC & MPCs) Course Type: Core (TH)

Course Code	SECPHY501C	Course Delivery Method	Class Room / Blended Mode
Credits	3	CIA Marks	30
No. of Lecture Hours / Week	3	Semester End Exam Marks	70
Total Number of Lecture Hours	45	Total Marks	100
Year of Introduction : 2022-23	Year of Offering: 2022-23	Year of Revision: -----	Percentage of Revision: -----

Course Objectives:

- To help students to understand the principles and laws of electricity which is essential to constantly emerging newest technologies
- To create interest among the students about the communication systems by studying electricity and electronics
- Students will be able to understand applications of passive elements, AC, DC circuits and power supplies

Course Outcomes:

At the end of this course, students should be able to:

- CO1 Understand the types of resistors, Inductors and capacitors and its applications
- CO2 Distinguish between AC and DC sources and understand about the batteries and Network theorems for DC circuits
- CO3 Explain the working principle and construction of Generators and transformers
- CO4 Learn the applications of EM induction and power supplies

SYLLABUS

Unit	Learning Units	Lecture Hours
I	<p>UNIT-I: INTRODUCTION TO PASSIVE ELEMENTS</p> <p>a) Passive elements Resistor - Types of Resistors, Color coding, Combination of Resistors – Series combination (Voltage division), Parallel combination (Current division), Ohms Law and its limitation. Inductor - Principle, Types of Inductors. Capacitor - Principle, Charging and discharging of a Capacitor, Types of Capacitors.</p> <p>b) Applications of Passive elements: Applications of a Resistor as a heating element in heaters and as a fuse element. Applications of Inductors, Application of choke in a fan and in a radio tuning circuit, Series resonance circuit as a Radio tuning circuit. Applications of Capacitor in power supplies, motors (Fans).</p>	9
II	<p>UNIT-II: POWER SOURCES (BATTERIES)</p> <p>a) Power sources: Types of power sources-DC & AC sources, Different types of batteries, Rechargeable batteries - Lead acid batteries, Li-ion batteries, Series, Parallel & Series-Parallel configuration of batteries</p> <p>b) Network Theorems for DC circuits Thevenin’s theorem, Norton’s theorem, Maximum Power transfer theorem, Constant Voltage source - Constant Current Source-Applications of Current sources & Voltage sources.</p>	9
III	<p>UNIT-III: ALTERNATING & DIRECT CURRENTS</p> <p>a) A.C Generator, Construction and its working principle, DC Generator, Construction and its working principle, advantages and disadvantages, Differences between DC and AC generators</p> <p>b) Transformers- Construction and its working principle, Open circuit and short circuit tests, Types of Transformers - Step-down and Step-up Transformers, Relation between primary and secondary turns of the transformer with emf, Use of Transformer in a regulated Power supply</p>	9
IV	<p>UNIT-IV: MODULATION CIRCUITS (Skill Based)</p> <p>a) Amplitude modulation: Amplitude modulation, modulation index, Waveforms, Power relations, AM transmitter, AM Receiver, Demodulation, Diode detector</p> <p>b) Frequency modulation: Frequency modulation, modulation index, Waveforms, FM Transmitter, FM Receiver</p>	9
V	<p>Unit-V: Applications of EM Induction & Power Supplies (Skill Based)</p> <p>a) DC motor – Construction and operating principle, Calculation of power, voltage and current in a DC motor, Design of a simple Motor (Fan) with suitable turns of coil</p> <p>b) Working of a DC regulated power supply, Construction of 5 volts regulated power supply, Design of a step-down (ex:220-12V) and step-up (ex:120-240V) transformers- Simple Design of FM Radio circuit using LCR series resonance (tuning) circuit, Design of a simple 5 volts DC charger</p>	9

References:

1. Grob's Basic Electronics by Mitchel Schultz , TMH or McGraw Hill
2. Electronic and Electrical Servicing by Ian Robertson Sinclair, John Dunton, Elsevier Publications
3. Troubleshooting Electronic Equipment by R.S.Khandapur ,TMH
4. Web sources suggested by the teacher concerned and the college librarian including reading material.

Course : **Applications of Electricity & Electronics**

PRACTICAL (Laboratory) SYLLABUS (*Max Marks:50*)

EXPERIMENTS LIST

Minimum SIX experiments are to be done and recorded

1. Measurement of R using Color coding of Resistors and measurement of R using multimeter - **Resistors of different values, Multimeters**
2. Connect two or three resistors or capacitors or inductors and measure the Series, Parallel Combination values using a Multimeter and compare the values with the calculated values - **Capacitors of different values**
3. Use the Digital Multimeter and Analog Multimeter to measure the output voltage of an AC & DC power supply - **Digital Multimeters, Analog Multimeters**
4. Use the Multimeter to check the functionality of a Diode and Transistor. Also test whether the given transistor is PNP or NPN - **Different types of Transistors and Diodes**
5. Construct a series electric circuit with R, L and C having an AC source and study the frequency response of this circuit. Find the Resonance Frequency. – **Series Resonance Experiment (Function generators)**
6. Construct a Parallel electric circuit with R, L & C having an AC source and study the frequency response of this circuit .Find the resonant frequency. – **Parallel Resonance Experiment (Function generators)**
7. Test whether a circuit is a Open circuit or Short Circuit by measuring continuity with Multimeter and record your readings. – **Experimental Kit to do the tests**
8. AM Generation Kit
9. FM generation Kit

Project Work:

1. Acquainting with the soldering techniques
2. Design and Construction of a 5 Volts DC unregulated power supply
3. Construction of a Step down Transformer and measurement of its output voltage. And to compare it with the calculated value.

Lab References:

1. Laboratory Manual for Introductory Electronics Experiments by Maheshwari, L.K. Anand, M.M.S., New Age International (P) Ltd.
2. Electricity-Electronics Fundamentals: A Text-lab Manual by Paul B. Zbar, Joseph Sloop, & Joseph G. Sloop , McGraw-Hill Education
3. Laboratory Manual Basic Electrical Engineering by Umesh Agarwal, Notion Press
4. Basic Electrical and Electronics Engineering by S.K. Bhattacharya , Pearson Publishers.
5. Web sources suggested by the teacher concerned.

**The Guidelines to be followed by the question paper setters in PHYSICS for the
V/VI- Semester - end exams**

SEMESTER – V/VI	PAPER CODE : SECPHY501C
PAPER TITLE : Applications of Electricity & Electronics ACADEMIC YEAR-2022-2023	

Weightage for the question paper :

syllabus	Section-A (Short answer questions)	Section-B (essay questions)
Unit-1 (30 Marks)	2	2
Unit-2 (30Marks)	2	2
Unit-3 (30Marks)	2	2
Unit-4 (15Marks)	1	1
Unit-5 (15 Marks)	1	1

- Each Short answer question carries 5 marks in Section –A
- Each Essay question carries 10 marks in Section –B
- The Question papers setters are requested to cover all the topics in the syllabus stipulated as per the weightage given by us.



**A.G. & S.G.SIDDHARTHA DEGREE COLLEGE OF ARTS & SCIENCE
(AUTONOMOUS), VUYYURU.**

(Accredited at "A" Grade by NAAC, Bangalore)

III B.Sc ,PHYSICS
SEMESTER – V/VI

PAPER CODE : SECPHY501C

PAPER TITLE : **APPLICATIONS OF ELECTRICITY & ELECTRONICS**

ACADEMIC YEAR-2022-2023

Time: 3Hours

Maximum marks: 70

Minimum marks: 28

MODEL PAPER

Section – A

Answer any **Four** of the following

(4X5=20M)

1. What is Ohm's law? Explain. (CO1, L1)
- 2.. Explain the Series resonance circuit as a Radio tuning circuit. (CO1, L1)
3. Explain series-parallel configuration of batteries. (CO2, L1)
4. Write the applications of current and voltage sources. (CO2, L1)
5. Write the Differences between DC and AC generators. (CO3, L2)
6. Explain the use of a Transformer in a regulated Power supply. (CO3, L1)
7. Briefly explain the concept of demodulation. (CO4, L1)
8. Write a short note on step-down and step-up transformers. (CO5, L1)

Section - B

Answer any **FIVE** of the following

(5X10 = 50M)

9. Briefly explain the different types of resistors and capacitors. (CO1, L1)
10. Write a note on applications of passive and active elements. (CO1, L1)
11. Describe Li- ion batteries. (CO2, L2)
12. Briefly explain the Thevenin's theorem. (CO2, L2)
13. Explain the construction and working principle of AC generator. (CO3, L1)
14. Explain the construction and working principle of Transformers. (CO3, L1)
15. What is amplitude modulation? Explain. (CO4, L2)
16. Explain the construction and operating principle of DC motor. (CO5, L1)

A. G & S.G. SIDDHARTHA DEGREE COLLEGE OF ARTS & SCIENCE
VUYYURU-521165.
NAAC recredited at 'A' level
Autonomous -ISO 9001 – 2015 Certified

Domain Subject: **PHYSICS**

Title of the Paper : **ELECTRONIC INSTRUMENTATION** Semester: V/VI

[Skill Enhancement Course (Elective)] Offered to : III B.Sc (MPC & MPCs) Course Type: Core (TH)

Course Code	SECPHY502C	Course Delivery Method	Class Room / Blended Mode
Credits	3	CIA Marks	30
No. of Lecture Hours / Week	3	Semester End Exam Marks	70
Total Number of Lecture Hours per semester	45	Total Marks	100
Year of Introduction : 2022-23	Year of Offering: 2022-23	Year of Revision: -----	Percentage of Revision: -----

Course Objectives:

- Explain basic concepts and definitions in measurement.
- Describe the bridge configurations and their applications.
- Elaborate discussion about the importance of electronic instruments

COURSE OUTCOMES

On successful completion of this course, the students will be able to:

CO1 Understand the basic measurements of Instruments (accuracy, precision, range, resolution, sensitivity and errors). Understand the theory, working principle, specifications and significance of Multimeter.

CO2 Describe the function of basic building blocks of Cathode Ray Oscilloscope. Measure the appropriate parameters (Voltage, Time Period, Frequency and Phase angle)

CO3 Understand the A/D & D/A converters and display instruments

CO4 Gain knowledge about amplifiers, oscillators and biomedical instruments

CO5 Understand the fundamental theory of Transducers and bridges

SYLLABUS

Unit	Learning Units	Lecture Hours
I	<p>UNIT-I INTRODUCTION TO INSTRUMENTS</p> <p>a) Basic of measurements: Instruments accuracy, precision, sensitivity, resolution, range, errors in measurement, Classification of Instruments, Analog instruments & Digital Instruments, Construction and working of an Analog Multimeter and Digital Multimeter (Block diagram approach), DC Voltmeter and AC Voltmeter, Sensitivity, Sources of errors in the Measurement of resistance, voltage and current</p> <p>b) Specifications of multimeter and their significance, Basic ideas on Function generator (brief explanation)Balancing and damping Moving iron instruments &PMMC instruments - extension of range.</p>	9
II	<p>UNIT-II OSCILLOSCOPE</p> <p>a) Cathode ray oscilloscope – Principle and block diagram of CRO - Cathode Ray Tube – functioning – various controls</p> <p>b) Applications CRO: Measurement of voltage (dc and ac), frequency& time period, Different types of oscilloscopes and their uses, Digital storage Oscilloscope</p>	9
III	<p>UNIT-III TRANSDUCERS AND BRIDGES</p> <p>a) Classification of Transducers, Resistive, Capacitive & Inductive transducers, Piezoelectric transducer, Photo transducer, Digital transducer.</p> <p>b)DC bridge – Wheatstone’s bridge, AC Bridges - Measurement of Inductance and Capacitance – Maxwell’s bridge, Hays bridge</p>	9
IV	<p>UNIT-IV ADC AND DAC & DISPLAY INSTRUMENTS</p> <p>a)A/D & D/A converters - Binary ladder, A/D converters – continuous type, integrating type, successive approximation type.</p> <p>b)Introduction to Display devices, LED Displays, Seven Segment Displays, Construction and operation (Display of numbers).</p>	9
V	<p>UNIT-V AMPLIFIERS, OSCILLATORS & BIOMEDICAL INSTRUMENTS (9hrs)</p> <p>a) Amplifiers – Classification of amplifiers, Coupling amplifiers – RC Coupled amplifier – frequency response characteristics (no derivation), Feedback in Electronic circuits – Positive and Negative feedback, Barkhausen criteria, RC phase shift oscillator</p> <p>b) Basic operating principles and uses of (i) Clinical thermometer (ii) Stethoscope (iii) ECG machine (iv) Radiography (v) Ultrasound scanning</p>	9

Reference Books:

1. Electronic Instrumentation by H.S.Kalsi ,TMH Publishers
2. Electronic Instrument Hand Book by Clyde F. Coombs ,McGraw Hill
3. Introduction to Biomedical Instrumentation by Mandeep Singh, PHI Learning.
4. Electronic Instrumentation – WD Cooper
5. Electrical and Electronic Instrumentation – AK Sawhany
6. A text book in electrical technology by B.L. Thereja (S.Chand&Co)
7. *Biomedical Instrumentation and Measurements* by Leslie Cromwell ,Prentice Hall India.
8. Electronic Measurements and Instrumentation by Kishor, K Lal, Pearson, New Delhi
9. Electrical and Electronic Measurements by Sahan, A.K., Dhanpat Rai, New Delhi
10. Electronic Instruments and Measurement Techniques by Cooper, W.D. Halfbrick, A.B., PHI Learning, New Delhi
11. Web sources suggested by the teacher concerned and the college librarian including reading material.

Course : **Electronic Instrumentation– PRACTICAL SYLLABUS**

Practical (Laboratory) Syllabus: (Max Marks:50)

Minimum SIX experiments are to be done and recorded

1. Familiarization of digital multimeter and its usage in the measurements of (i) resistance (ii) current, (iii) AC & DC voltages
2. Measure the AC and DC voltages, frequency using a CRO and compare the values measured with other instruments like Digital multimeter.
3. Formation of Sine, Square wave signals on the CRO using Function Generator and measure their frequencies. Compare the measured values with actual values.
4. Display the numbers from 0 to 9 on a single Seven Segment Display module by applying voltages.
5. Displacement transducer - LVDT
6. A.C - Impedance and Power Factor.
7. Maxwell's Bridge – Determination of Inductance.
8. Measurement of body temperature using a digital thermometer and list out the error and corrections.
9. Measurement of Blood Pressure of a person using a B.P. meter and record your values and analyze them.
10. Display the letters **a** to **h** on a single Seven Segment Display module by applying voltages.
11. Get acquainted with an available ECG machine and study the ECG pattern to understand the meaning of various peaks
12. Observe and understand the operation of a Digital Pulseoxymeter and measure the pulse rate of different people and understand the working of the meter.

VI. Lab References:

1. Electronic Measurement and Instrumentation by J.P. Navani, S Chand & Co Ltd
2. Principles of Electronic Instrumentation by A De Sa, Elsevier Science Publ.
3. Electronic Measurements and Instrumentation by S.P. Bihari, Yogita Kumari, Dr. Vinay Kakka, Vayu Education of India.
4. Laboratory Manual For Introductory Electronics Experiments by Maheshwari, New Age International (P) Ltd., Publishers.
5. Electricity-Electronics Fundamentals: A Text-lab Manual by Paul B. Zbar, Joseph Sloop, & Joseph G. Sloop, McGraw-Hill Education.
6. Web sources suggested by the teacher concerned.

The Guidelines to be followed by the question paper setters in PHYSICS for the V/VI- Semester - end exams

SEMESTER – V/VI	PAPER CODE : SECPHY502C
PAPER TITLE : ELECTRONIC INSTRUMENTATION	
ACADEMIC YEAR-2022-2023	

Weightage for the question paper :

syllabus	Section-A (Short answer questions)	Section-B (essay questions)
Unit-1 (30 Marks)	2	2
Unit-2 (25Marks)	1	2
Unit-3 (30Marks)	2	2
Unit-4 (15Marks)	1	1
Unit-5 (20 Marks)	2	1

- Each Short answer question carries 5 marks in Section –A
- Each Essay question carries 10 marks in Section –B
- The Question papers setters are requested to cover all the topics in the syllabus stipulated as per the weightage given by us.



**A.G. & S.G.SIDDHARTHA DEGREE COLLEGE OF ARTS & SCIENCE
(AUTONOMOUS), VUYYURU.**

(Accredited at "A" Grade by NAAC, Bangalore)

III B.Sc ,PHYSICS ,
SEMESTER – V/VI

PAPER CODE : SECPHY502C

PAPER TITLE : ELECTRONIC INSTRUMENTATION

ACADEMIC YEAR-2022-2023

Time: 3Hours

Maximum marks: 70

Minimum marks: 28

MODEL PAPER

Section - A

Answer any Four of the following

(4X5=20M)

1. Mention the difference between accuracy and precession of a measurement.(CO1, L1)
2. Write the uses of function generator. (CO1, L2)
3. Write a short note on digital transducer. (CO2, L1)
4. What are the various applications of CRO?(CO2, L2)
5. Explain about DC bridge ?
6. Explain LED display systems. (CO4, L1)
7. What is Barkhausen criteria? (CO5, L1)
8. Explain the importance of ultrasound scanning. (CO5, L1)

Section -B

Answer any FIVE of the following :

(5X10 = 50 M)

9. Define error. Mention different types of Errors. Explain any three types of errors associated with measurements. (CO1, L2)
10. What is a multimeter? What are the advantages of analog multimeter? How do we measure voltage using analog multimeter? (CO1, L2)
11. Describe the principle and working of CRO.(CO2, L1)
12. Write a brief note on different types of oscilloscopes and their uses.(CO2, L1)
13. Explain in brief Piezoelectric transducer and Photo transducer.(CO3, L1)
14. Discuss about Wheatstone's bridge.(CO3, L1)
15. Explain A/D and D/A converters.(CO4, L1)
16. What is an amplifier? Explain RC coupled amplifier.(CO5, L2)

**A.G& S.G.SIDDHARTHA DEGREE COLLEGE OF ARTS &
SCIENCE**

VUYYURU-521165, KRISHNA Dt., A.P.(Autonomous)

Accredited by NAAC with "A" Grade

2022-2023



DEPARTMENT OF POLITICAL SCIENCE

MINUTES OF BOARD OF STUDIES

ODD SEMESTER

27-10-2022



**A.G & S.G SIDDHARTHA DEGREE COLLEGE OF
ARTS AND SCIENCE::VUYYURU**

(An Autonomous College in the Jurisdiction of Krishna University)

Accredited at the level 'A' by the NAAC

Sponsors: Siddhartha Academy of General & Technical Education

DEPARTMENT OF POLITICAL SCIENCE

Minutes of the meeting of Board of Studies in Political Science of A.G. &S.G Siddhartha Degree College of Arts & Science, Vuyyuru held at 10:00 A.M On 27/10/2022 in the Department of Political Science

Members Present		
Name of the Member	Role	Signature
Smt. Ch. Sandhya Rani, HOD, Dept. of Political Science, A.G & S.G Siddhartha Degree College of Arts & Science, Vuyyuru-521165. Mobile: 9949402837 E-Mail: narrasandhyarani@gmail.com	Chairman	
Sri. M. Padhmanabham, Assistant Professor, Dept of Political Science, SRR & CVR Govt Degree College ,Vijayawada. Mobile: 9490772836	University Nominee, Krishna University	
SmtG.Padmaja, Head, Department of Political Science, S.D.M. Siddhartha MahilaKalasala, Vijayawada. Mobile: 9441883417	Academic Council Nominee	
Dr.G.Veerraju, H.O.D Professor, Dept of Political Science,Andhra university Visakhapatnam Mobile: 9440476494	Academic Council Nominee	
Sri. R.V.Siva Rao, Lecturer Dept. of Political Science, A.G & S.G Siddhartha Degree College of Arts & Science, Vuyyuru-521165. Mobile:9391380250	Academic Council Member	

AGENDA

1. To review and recommend changes to syllabi model paper and guidelines in the 1st, 3rd and 5th semesters of B.A
2. To discuss about and recommend the pattern of assessment i.e., internal and external assessment percentage to be followed for Third Semester from academic year 2022-2023
3. To recommend the guidelines to be followed by the Question Paper Setters in Political Science for all semester-end exams.
4. To recommend the teaching and the evaluation methods to be followed under the Autonomous System.
5. To Suggest innovative methods of teaching
6. To propose the panel of Question Paper Setters and Examiners.

RESOLUTIONS

Following resolutions are made in the Board of Studies in Political Science :

- 1) It is resolved to include INTRODUCTION TO POLITICAL SCIENCE for Semester-I for the 1st Degree from the Academic Year 2022-2023.
- 2) It is resolved to introduce INDIAN GOVERNMENT AND POLITICS for semester-III for the 2nd Degree from the Academic Year 2022-2023.
- 3) To continue with the existing syllabus for 5th semester with change for the Academic Year 2022-2023.
- 4) To adapt 30 marks for internal assessment and 70 marks for external assessment for 1st Degree and 25 marks for internal assessment and 75 marks for external assessment for 2nd and 30 marks for internal assessment and 70 marks for external assessment 3rd year Degree from the Academic Year 2022-2023.
- 5) To follow the new model question paper from the Academic Year 2022-2023 for all the B.A Students
- 6) To adapt the following teaching and evaluation methods:

Teaching Methods:

Besides the conventional methods of teaching, it is also resolved to use various other methods like group discussions, quiz, developing power point presentation etc., for the better understanding of the contents.

Evaluation Method for Internal Theory Examination for 1st B.A students and 3rd B.A students

First Internal Exam	Second Internal Exam	Average	Attendance	Activity	Total
A	B	$C=(A+B) / 3$	D	E	(C+D+E)
30 Marks	30 Marks	20 Marks	5 Marks	5 Marks	30 Marks

Evaluation Method for Internal Theory Examination for 2nd

First Internal Exam	Second Internal Exam	Average	Assignment	Total
A	B	$C=(A+B) / 2$	D	(C+D)
20 Marks	20 Marks	20 Marks	5 Marks	25 Marks

- 7) Semester End Examinations:
- 8) The maximum marks of sem-end examinations for 1st B.A and 3rd B.A are 70 and 2nd B.A are 75 Marks from the Academic Year 2022-2023 for all the B.A Students and the duration of the examination shall be 3 Hours.
- 9) To Organize Seminars ,Guest Lectures and Workshops to upgrade the knowledge of the students and to impart new skills of learning as frequently as possible.
- 10) To authorize the chairman of board of studies to suggest the panel of paper setters and examiners to the controller of examinations as per the requirement.

A.G &S.G SIDDHARTHA DEGREE COLLEGE OF ARTS & SCIENCE VUYYURU-521165

(An Autonomous College in the jurisdiction of Krishna University , Machilipatnam)

Title of the paper: INTRODUCTION TO POLITICAL SCIENCE

Semester-I

Course Code	POLTIIB	Course Delivery Method	Class Room
Credits	4	CIA Marks	30
No.of Lecture Hours/Week	5	Semester End Exam Marks	70
Total Number of Lecture Hours	60	Total Marks	100
Year of Introduction 20202021	Year of offering 2022-2023	Year of Revision 2022-2023	Percentage of Revision 0%

Course Context and overview: To train students in order to have clear understanding of politics, related concepts such as government, state sovereignty, legitimacy, power, influence, authority, democracy, power, political participation, political system etc.

COURSE OUTCOMES: INTRODUCTION TO POLITICAL SCIENCE

Course Outcomes: At the end of the course the student will be able to:

CO1: Define important field-specific theories and concepts, and understand their role in developing political science Knowledge: L-1 , L-2

CO2: Summarize conceptual arguments or theoretical approaches. L-3 , L-4

CO3: Apply them to field relevant situations and support their application with appropriate evidence. L-3, L-4

CO4: Compare and evaluate the merits of multiple policies, theories or concepts from different disciplinary perceptions. L-5

CO5: With the course, students are expected to learn the political concepts and theory in the Basic

Concepts of Political Science. L-1, L-2

Learning Outcome:

On successful completion of the course the students will be able to:

- Recall the previous knowledge about Political Science and understand the nature and scope, traditional and modern approaches of Political Science.
- Understand concepts intrinsic to the study of Political Science.
- Have a solid theoretical understanding of Rights and its theories along with the basic aspects of certain political ideologies.
- Apply the knowledge to observe the field level phenomena.

UNIT: I INTRODUCTION:

15hrs.

1. Definition, Nature, Scope and Importance of Political Science - Relations with allied

Disciplines (History, Economics, Philosophy and Sociology)

2. Approaches to the study of Political Science:

Traditional Approaches- Historical, Normative and Empirical Approaches.

Modern Approaches: Behavioral and System Approach.

UNIT-II: STATE :

15 hrs

Definition of the State, Elements of the State, Theories of Origin of the State-(Divine Origin, Force, Evolutionary and Social Contract),

1. Concepts of Modern State and Welfare State.

UNIT-III: CONCEPTS OF POLITICAL SCIENCE:

10 hrs

1. Law, Liberty,

2. Power, Authority and Legitimacy

UNIT: IV: THEORIES OF RIGHTS:

10 hrs

2. Meaning, Nature and Classification of Rights

3. Theories of Rights.

UNIT: V: POLITICAL IDEOLOGIES:

10 hrs

1. Liberalism, Individualism and Anarchism.

2. Socialism, Marxism and Multiculturalism.

REFERENCE BOOKS:

1. Sukhbir Bhatnagar : Constitutional Law and the Governance
2. A. C. Kapur : Select Constitution
3. R.C. Agarwal : Political Theory
4. Vidyadhar Mahajan : Political Theory(Principles of Pol.Sci.

5. Devi & V. Bhogendra Acharya,
6. Prof. V. Ravindra Sastry (ed) : Political Science Concepts, Theories & Institutions.

7. Jadi Musalaiah, V.Vasundhara
8. Laski H.J. : Grammar of Politics

9. A.Appadorai : Substance of Politics

10. Eddy Ashirvadam K.K.Misra : Political Theory

11. Sushila Ramaswamy : Political Theory: Ideas & Concepts

12. S.P. Varma : Modern Political Theory

13. O.P. Gauba : An Introduction to Political Science

14. Abbas, Hoveyda & Ranjay Kumar : Political Theory

15. Andrew Hakes : Political Theory, Philosophy, Ideology Science.

16. Rajeev Bhargava & Ashok Acharya (ed) : Political Theory An Introduction

17. Andrew Heywood : Political Ideologies-An Introduction

18. Norman Barry : An Introduction to Modern Political theory.

A.G &S.G SIDDHARTHA DEGREE COLLEGE OF ARTS & SCIENCE VUYYURU-521165

(An Autonomous college in the jurisdiction of Krishna University, Machilipatnam)

Reaccredited at 'A Grade by NAAC

MODEL QUESTION PAPER (Semester-I) Course Code : POLTIIB

Time: 3 Hours

Max. Marks : 70

SECTION -A

Answer the following

5 x14 = 70

1. (A). Explain meaning, definition and scope of Political Science. 10M
(B) Bring out the importance of the Behaviour method in the study of Political Science.. 10M
(OR)
C) Explain the relations between Political Science and Economics, 4m
D) Write a short on Normative Approach. 4M

2. (A) Explain the basic features of the State. IOM.
(B) Critically examine the Social Contract Theory of Political Science. IOM
(OR)
(C) Discuss Politics a Science or an art? 4M
(D) Write a short note on Divine Theory. 4M

3. (A) Explain the meaning, definition and types of Liberty...IOM
(B) Explain the meaning, Definition and features of Authority.IOM
(OR)
(C)Write a short note on Legitimacy. 4M
(D) Explain the types of Power. 4M

4. (A) Explain the meaning Definition and classification Rights, 10M
(B) Write an essay on Scientific Socialism. IOM
(OR)
(C) Write a short note on Surplus Value. IOM
(D) Multiculturalism. 4M

- 5.(A) Explain the Basic features of Liberalism 1OM
(B) Wrote an essay on Anarchism, 10M
(OR)
(C)Explain the types of Political rights 4M
(D) Explain the features of Liberalism4M

New syllabus

B.A. POLITICAL SCIENCE SECONDYEAR

THIRD SEMESTER (Under CBCS w.e.f.2022-23) Course-3:

INDIAN GOVERNMENT AND POLITICS

Course Code	POLT301C	Course Delivery Method	Class Room
Credits	4	CIA Marks	25
No.of Lecture Hours/Week	5	Semester End Exam Marks	75
Total Number of Lecture Hours	60	Total Marks	100
Year of Introduction 2020/2021	Year of offering 2022-2023	Year of Revision 2022-2023	Percentage of Revision 0%

Course Outcomes:

CO1: The students community has acquired knowledge of the making of the Indian Constitution and its philosophical background. L1

CO2: Information about the functionaries of the government both at the union and state level was acquainted by the student community. L1, L2

CO3: To Understand the legislative procedures which ensure the orderly conduct of business in our parliament and state legislative assemblies in India.

CO4: To understand know the Ministers, their role & responsibilities. L1, **CO5:** To understand Judiciary of India. L1, L2

Learning Outcomes:

On successful completion of the course the students will be able to:

- Acquire knowledge about the historical background of Constitutional development in India, appreciate philosophical foundations and salient features of the Indian Constitution.

- Analyze the relationship between State and individual in terms of Fundamental Rights and Directive Principles of State Policy.
- Understand the composition and functioning of Union Government as well as State Government and finally
- Acquaint themselves with the judicial system of the country and its emerging trends such as judicial reforms.

UNIT-I :	SOCIAL AND IDEOLOGICAL BASE OF THE INDIAN CONSTITUTION	15hrs
	1. Constitutional Development in India during British Rule-A Historical	
	2. Constituent Assembly-Nature, Composition, Socio-Economic, Philosophical Dimensions and Salient Features of the Indian	

UNIT-II	INDIVIDUAL AND STATE	15 hrs
	1. Fundamental Rights, Directive Principles of State Policy and Fundamental Duties-Differences between Fundamental Rights and Directive Principles of State Policy.	
	2. The 'Doctrine of Basic Structure of the Constitution' with reference to Judicial Interpretations and Socio-Political Realities.	

UNIT-III :		
	UNION EXECUTIVE	10 hrs
	1. President of India-Mode of Election, Powers and Functions. 2. Parliament-Composition, Powers and Functions, Legislative	

Committees, Prime Minister and Council of Ministers-Powers and

UNIT-IV :	STATE EXECUTIVE 10 hrs
	1. Governor-Mode of Appointment, Powers and Functions.
	2. Legislature-Composition, Powers and Functions, Chief Minister and

UNIT-V :	THE INDIAN JUDICIARY 10 hrs
	1. Supreme Court-Composition and Appointments, Powers and Functions or Jurisdiction of the Supreme Court, Judicial Review, Judicial Activism.
	2. High Court-Composition, Powers and Functions, Debates on the mode of appointment of Judges-National Judicial Appointments

A.G &S.G SIDDHARTHA DEGREE COLLEGE OF ARTS & SCIENCE
[AUTONOMOUS] VUYYURU-521165

SEMESTER-III CODE-POLT301C ACADEMIC YEAR-2022-2023

PAPER TITLE:INDIAN GOVERNMENT AND POLITICS

Duration: 3 Hours

Maximum Marks:75

Pass Marks:30

Section-A

Answer any Five of the following questions

(5x5=25 Marks)

- 1.Constitutional assembly
- 2.Explain legislative act 1909
- 3.Describe the Fundamental duties of Indian citizens
- 4.Difference between fundamental duties and DPSP
- 5.Discuss the various parliamentary committee's
- 6.Election method of Indian president
- 7.State legislative assembly
- 8.Judicial review

Section-B

Answer the following: Each carries TEN Marks

(5x10=50 Marks)

9 A.Explain the salient features of the Indian Constitution.

(OR)

B.Explain 1935 Indian legislature ACT

10. A. Explain the Fundamental Rights of the Constitution.

(OR)

B.Explain Direct Principal of State policy

11.A.Explain the powers and Functions of the President of India.

(OR)

B.Explain the powers and Functions of Prime Minister.

12. A Explain the powers and Functions of Chief Minister.

(OR)

Explain the powers and Functions of Governor.

13.A.Describe the structure and Functions of Supreme Court of India.

(OR)

B.Describe the structure and Functions of High Court of India.

Course 6 B: E GOVERNANCE

(Skill Enhancement Course (Elective), 4 credits)

A.G. & S.G.SIDDHARTHA DEGREE COLLEGE OF ARTS & SCIENCE (AUTONOMOUS), (2022-23)
VUYYYURU

PAPER TITLE : PAPER-V (CORE): **E GOVERNANCE**

Course Code	POL501C	Course Delivery Method	Class Room
Credits	4	CIA Marks	30
No.of Lecture Hours/Week	5	Semester End Exam Marks	70
Total Number of Lecture Hours	60	Total Marks	100
Year of Introduction 20202021	Year of offering 2022-2023	Year of Revision 2022-2023	Percentage of Revision 0%

I. **Outcomes:**

Students at the successful completion of the course will be able to:

- Co1. Acquaint students with the introduction to good governance and how it can be achieved by information and communication technology.
- Co2. Understand the growing needs of E-Governance, improving transparency in the system of governance.
- Co3. Have understanding of various government schemes and E-Governance projects and initiatives.
- Co4. Provide the practical knowledge about the effective delivery of citizen services through online mode.
- Co5. Realize the issues and challenges of E-Governance.

II. Syllabus: (Hours: Teaching: 60, Training: 10, Others incl. unit tests: 05)

Unit: 1

Brief Introduction to Governance-E-Governance –Meaning, Definition, Nature, Scope, Objectives and Significance-Domains of E-Governance- E-Governance and Good Governance-Global trends in the growth of E-Governance.

Unit: 2

E-Governance in India- - National E-Governance Plan (NeGP)-National Informatics Centre- Strategies for E-Governance-E-Governance Implementations: Required infrastructure of Network, Computing, Cloud Governance, Data system, Human resources, Legal and Technological infrastructure-

Unit: 3

Role of Information and Communication Technology in Administration, Effective delivery of services for public utilities through E-Governance-Online filing of complaints, application registration, issuance of certificates, issuance of land records, online payments of fees, dues etc, e- tendering, easy access to information and E-Governance in Social security and welfare schemes: Direct transfer of benefits, Biometric authentication through Aadhar, etc.

Unit: 4

E-Governance under Information Technology Act-Legal status for digital transactions-Public Private Partnership and expansion of E-Governance. E-Governance-Transparency and Accountability at gross root level-Issues and Challenges: Digital Divide, Capacity Building, Cyber Security in Cyber Crimes, Socio-political implications, Issues of integration, Networking with NGOs.

Unit: 5

Major E-Governance Projects and Initiatives:Gyandoot, E-choupal, E-Bhoomi, E-Seva, CARD, E-Panchayat, Real Time Governance (RTG) etc.

Additional Input

Unique Identification Authority of India
E-Government Development Index
E-Governance case studies from other countries

III. References:

1. B.Sreenivas Raj, E-Governance Techniques-Indian and Global Experiences, New Century Publications, New Delhi, 2008.
2. Subhash Bhatnagar, Unlocking E-Government Potential-Concepts, Cases and Practical Insights, Sage Publications, New Delhi, 2009.
3. Y.Parthasaradhi, E-Governance and Indian Society, Kanishka Publications, New Delhi, 2009.
4. R.P.Sinha, E-Governance in India, Initiatives and Issues in India, Centre for Public Policy, 2006.
5. Anil Kumar Dhiman, E-Governance –Good Governance using ICTs, S.K.Book Agency, New Delhi, 2017.
6. Ashok Aggarwal, Governance-Case Studies, University Press India Pvt. Ltd, Hyderabad, 2017.
6. Web resources suggested by the Teacher concerned and the College Librarian including reading material.

IV. Co-Curricular Activities (Training of students by the teacher: Total 10 hours):

a) Mandatory:

1. **FOR TEACHER:** Training of students by teacher in the classroom for a total of not less than 10 hours on techniques of application of ICT for getting services from the government departments, filing of grievances through online mode, making digital transactions for issuance of certificates or payment of fees, identifying components in e-governance and techniques to handle cyber security etc.,
2. **FOR STUDENT:** Students have to visit urban or local administration offices and have practical study and assess the implementation of E-Governance initiatives, models, citizen centric services, citizen charter and interact with the beneficiaries about the fulfillment of their needs in time or not and if any lapses they noticed or visit to nearby government institution covering the various citizen centric services delivering through online mode and observe the citizen charter, mode of operation, time limitation, fees prescribed for services and observe the operation of Real Time Governance (RTG) in administration and record their experiences and individually submit his / her observation as a hand-written Fieldwork/Project work Report not exceeding 10 pages in the given format to the teacher.
3. **Suggested Fieldwork/Project work Format:**
Title Page, Student Details, Acknowledgements, Index page, Objectives, Step-wise process, Findings, Conclusion and References.
4. Max marks for Fieldwork/Project work Report: 05
5. Unit Tests /Internal Examinations

b) Suggested Co-Curricular Activities

1. Training of students by a related field expert.
2. Reading Daily newspapers either print or online about the misuse of technology which leads to cybercrimes.
3. Reading articles, blogs and websites for various ideological perspectives.

4. Assignments.
5. Discuss the debates around any recent technological advancements.
6. Discuss the case laws and judgments reported on E-Governance initiatives.
7. Seminars, Group discussions, Quiz, Debates etc.
8. Invited lectures and presentations on related topics by experts in Cyber Security especially the Police personnel associated with the cases of IT Act.

Section – A

I.ANSWER any TWO OF THE FOLLOWING. (2 ×5 = 10)

- 1.E-Goverance and Global Trends
- 2.Explain Required in infrastructure of Network
- 3.Role Information Communication and Technology in administration
- 4.Cyber Crimes

Section – B

Answer any FOUR of the following. (4 × 15 = 60)

- 5.What is the meaning Definition and Scope of E-Governance
- 6.Explain the E-Governance in India(NEGP)
7. Explain E-Governance Major Project
8. Explain Public Utilities of E-Governance services
9. Explain Social Securities and welfare Schemes
10. Explain Information Technology act
11. Transparency and account ability Challenges of E-Governance
- 12.Explain Cyber Security and Socio l Political Sectors

Course 7B: LOCAL ADMINISTRATION
(Skill Enhancement Course (Elective), 4 credits)

Max Marks: 100

I. Outcomes:

Students at the successful completion of the course will be able to;

- CO1. Understand the existing context of Local Government Institutions in India.
- CO2. Have knowledge on the need of empowerment and autonomy of LGIs.
- CO3. Provide an overview on financial resources and constitutional provisions.
- CO4. Analyze the issues, problems and conflicts in Local Administration.
- CO5. Develop communication skills to interact with the elected members and officials.
Enhance skills for observation, organizing, networking, documentation.

II. Syllabus:(Hours: Teaching: 60, Training: 10, Others incl. unit tests: 05)

Unit: 1

Local Government: Meaning, Nature and Importance, Thoughts on Local Governments by M.K.Gandhi, Jawaharlal Nehru and Dr.B.R.Ambedkar, Important Committees: Balwant Rai Mehta (1957), Ashok Mehta (1978), L.M.Singhvi(1986).

Unit: 2

Decentralization of powers (Political, Administrative and Economic) from the States to Local Institutions- 73rd and 74thConstitutional Amendment Acts-Empowering Local Governments- Decision making powers during crisis and disasters-Relationship between local government authorities and Central and State Government service providers-

Unit: 3

Revenue raising avenues for Local Governments-Grants, Aid and support from Centre and State Governments-Public Private Partnerships-Concept of Local Development-Village as a unit, SWOC analysis of a village, existing conditions, expected developmental opportunities, the gap, natural, government and private resources, year-wise planning, finances required –

Unit: 4

Challenges for Local Administration, Financial, administrative and Political Constraints- Public relations in Local Administration-Need for training for elected representatives and other stakeholders-Audit training and Participatory training.

Unit: 5

Role of District Collector in strengthening LGIs. Role of Local Governments in implementation of welfare and developmental programmes., (MGNREGS), (SGSY), (IAY) and (PURA).

Additional input:

Local Administration in Ancient India

III. References:

1. **Basu, D.D, Introduction to Constitution of India**, Nagpur, Lexis Nexis Butterworths, 2018
 2. Niraja Gopal Jayal, *Representing India: Ethnic Diversity and Governance of Public Institutions*, 2006, Palgrave Macmillan Publications.
 3. R Venkata Ravi, *Empowering Rural India: Experiments and Experiences*, Kanishka Publishers, New Delhi, 2006.
 4. Sawalia Bihari Verma, *Empowerment of the Panchayati Raj Institutions in India*, Sarup and Sons, New Delhi, 2006.
 5. World Bank, *Empowerment in Practice: Analysis and Implementation*, World Bank Institute, Washington D.C.
 6. S.Chandrasekhar, *Panchayati Raj and Financial Resources*, Regal Publications, 2008, New Delhi.
 7. Rajesh Tondon and Mohini Kak (Eds), *Citizen Participation and Democratic Governance*, New Delhi, 2016.
 8. Anand Prakash, *State and District Administration*, Wisdom Press, New Delhi, 2008.
 9. N.Lalitha, *Rural Development in India: Emerging Issues and Trends*, Dominant Publishers, New Delhi, 2014.
 10. Web resources suggested by the Teacher concerned and the College Librarian including reading material.
- IV. Co-Curricular Activities(Training of students by the teacher: Total 10 hours):
- a) Mandatory:
 1. FOR TEACHER: Training of students by teacher in the classroom for a total of not less than 10 hours on techniques of identifying financial resources to local bodies, skilling on various components involved in auditing of accounts, analyzing the data of beneficiaries of welfare schemes by using statistical tools, preparation of minutes and reports, imparting technical skills with regard to communication and procedures and practices in documentation.
 2. FOR STUDENT: Students have to visit to a Rural Local Government Institution, understand its profile, sources of revenue and expenditure, identify major issues and challenges, analyze its development and welfare initiatives, record the experiences, collecting data on implementation of poverty alleviation, employment generation schemes sponsored by governments and interpretation of data and indicate suggestions for better functioning (or) Participate in regular Gram Sabha meeting observe and record the proceedings and outcome of the meeting, indicate suggestions for better functioning of Gram Sabha (or) students may take a village as a unit, make SWOC analysis and individually submit his / her observation as a hand-written Fieldwork/Project work Report not exceeding 10 pages in the given format to the teacher.
 3. Suggested Fieldwork/Project work Format:

Title Page, Student Details, Acknowledgements, Index page, Objectives, Step-wise process, Findings, Conclusion and References.

4. Max marks for Fieldwork/Project work Report: 05
5. Unit Tests /Internal Examinations

b) Suggested Co-Curricular Activities

1. Training of students by a related field expert.
2. Reading Local Daily newspapers either print or online.
3. Reading Editorial pages, blogs and websites for various ideological perspectives.
4. Assignments.
5. Discuss the debates around any recent Ordinance, Bill or Act in the Parliament or State Legislature.
6. Carry out a resource mapping of a selected area.
7. Plan and organize a capacity building session for the stakeholders
8. Seminars, Group discussions, Quiz, Debates etc.

A.G. & S.G.SIDDHARTHA DEGREE COLLEGE OF ARTS &SCIENCE (AUTONOMOUS), (2022-23)
VUYYURU
PAPER-V (CORE):LOCAL ADMINISTRATION

Max:70 Pass:28

Section – A

I. ANSWER any TWO OF THE FOLLOWING. (2 × 5 = 10)

- 1.Thoughts of M.KGandhi in local self government
- 2.Ashokamhtha Committee
- 3.73th constitutional amendment
- 4.Reportning on function of local administration

Section – B

Answer any FOUR of the following. (4 × 15 = 60)

5. Meaning definition nature and importance of local self government
1. Decentralization of powers in political administration and economics
2. 74th constitutional amendments
3. Local of district collector in local self-government
4. Explain role of local self governmentimplementation in welfare development programmes
5. Explain challenges of local administration of financial political administration
6. Explain different types of Reports
7. Balwantraimetha Committee

A.G. & S.G.SIDDHARTHA DEGREE COLLEGE OF ARTS & SCIENCE (AUTONOMOUS), (2022-23)

(To Be Implemented from Academic Year - 2020-21) PROGRAMME: FOUR YEAR B.A. (Hons)

Domain Subject: POLITICAL SCIENCE

Skill Enhancement Courses for Semester- V

(Syllabus with Learning Outcomes, References, Co-curricular Activities & Model Q.P. Pattern)

Structure of SECs for 5th Semester

(To Choose One pair from the Four alternative pairs of SECs)

Uni Code	Course Number 6 & 7	Name of Course	Hours / Week	Credits	Marks	
					I.A – 20 Field Work-10	Sem End
	6A	Political Reporting	5	4	30	70
	7A	Legal literacy-Rights Awareness	5	4	30	70

OR

	6B	E-Governance	5	4	30	70
	7B	Local Administration	5	4	30	70

OR

	6C	Office Management	5	4	30	70
	7C	Personnel Administration	5	4	30	70

OR

	6D	Electoral Politics and Voting Behavior	5	4	30	70
--	----	--	---	---	----	----

	7D	Legislative Procedure and Practices	5	4	30	70
--	----	--	---	---	----	----

Note-1: Note: For Semester–V, for the domain subject Political Science, any one of the four pairs of SECs shall be chosen as courses 6 and 7, i.e., 6A & 7A or 6B & 7B or 6C & 7C or 6D & 7D. The pair shall not be broken (ABCD allotment is random, not on any priority basis).

Note-2: One of the main objectives of Skill Enhancement Courses (SEC) is to inculcate skills related to the domain subject in students. The syllabus of SEC will be partially skill oriented. Hence, teachers shall also impart practical training to students on the skills embedded in syllabus citing related real field situations.

THE END

**A.G& S.G.SIDDHARTHA DEGREE COLLEGE OF ARTS &
SCIENCE**

VUYYURU-521165, KRISHNA Dt., A.P.(Autonomous)

Accredited by NAAC with "A" Grade

2022-2023



DEPARTMENT OF STATISTICS

MINUTES OF BOARD OF STUDIES

ODD SEMESTER

05-11-2022

Minutes of the meeting of BOS in Statistics for B.Sc(MSCs) Degree

**Courses of AG & SG Siddhartha Degree College of Arts & Science, Vuyyuru,
held at 2.30 PM on 05-11-2022 through online mode.**

N.V. SrinivasaRao

Presiding

Members Present:

- 1) *N.V. Srinivasa Rao*
(N.V.Srinivasa Rao) Chairman Head, Department of Mathematics, AG & SG S Degree College.
- 2) *P. Ravi Kumar*
(P. Ravi Kumar) University Nominee Department of Statistics, Pavitra Degree College, Machilipatnam.
- 3) *G. Chakravarthy*
(G. Chakravarthy) Subject Expert Department of Statistics, P. B. Siddhartha College, Vijayawada
- 4) *N. Siva Naga Raju*
(N. Siva Naga Raju) Member Lecturer in Statistics AG & SG S Degree College.
- 5) *D. Sunitha*
(D.Sunitha) Member Lecturer in Mathematics AG & SG S Degree College.
- 6) *A. Bhargavi*
(A.Bhargavi) Member Lecturer in Mathematics AG & SG S Degree College.
- 7) *Noor Mohammad*
(Noor Mohammad) Member Lecturer in Mathematics AG & SG S Degree College.
- 8) *K. Rajya Lakshmi*
(K. Rajya Lakshmi) Member Lecturer in Mathematics AG & SG S Degree College.

Agenda of B.O.S Meeting:

1. To discuss and recommend the Syllabi, Model Question Papers and Guidelines to be followed by question paper setters in Statistics for 1stSemester as per the guidelines and instructions prescribed APSCHE and Krishna University from the Academic Year 2022-23.
2. To discuss and recommend the Syllabi, Model Question Papers and Guidelines to be followed by question paper setters in Statistic for 3rdSemester as per the guidelines and instructions prescribed APSCHE and Krishna University from the Academic Year 2022-23.
3. Discussed and recommended the teaching and evaluation methods for approval of Academic Council
4. Any other matter.

Resolutions.

1. Discussed and recommended that no changes are required in Syllabi. Changes are required in Model Question Papers and Guidelines to be followed by the question paper setters in Statistics for 1stSemester from the Academic year 2022-23.
2. To recommend the teaching and evaluation methods to be followed under Autonomous status. The maximum marks for IA is 30 and SE is 70. Each IA written examination is of 1 Hr.30 min duration for 30 marks. The tests will be conducted centrally. The average of two such IA is calculated for 20 marks. 5 marks will be allotted for attendance and 5 marks are allotted for Assignment/ Activity. There is no minimum passing for IA and there is no provision for improvement in IA. Even though the candidate is absent for two IA exams/obtain zero marks the external marks are considered (if he/ she gets 40 out of 70) and the result shall be declared as 'PASS' from the Academic year 2022-23.
3. To introduce new Syllabi, Model Question Papers and Guidelines to be followed by the question paper setters in Statistics of 3rdSemester from the Academic year 2022-23. The maximum marks for IA is 25 and SE is 75. Each IA written examination is of 1 Hr. duration for 15 marks. The tests will be conducted centrally. The average of two such IA is calculated for 15 marks. 5 marks will be allotted basing on Assignment and 5 marks are allotted for activity. There is no minimum passing for IA and there is no provision for improvement in IA. Even though the candidate is absent for two IA exams/obtain zero marks the external marks are considered (if he/ she gets 40 out of 75) and the result shall be declared as 'PASS' from the Academic year 2022-23.
4. Discussed and recommended for organizing seminars, Guest lecturers, Online Examinations and Workshops to upgrade the knowledge of students for Competitive Examinations for the approval of the Academic Council.

A.G. & S.G. Siddhartha Degree College of Arts & Science

Vuyyuru, Krishna District

Department of Statistics

Programme Specific Outcomes (PSOs)

- PSO1 : Apply the concepts, principles and methods of statistics to various fields of study
- PSO2 : Understand the importance and value of statistical principles and convert a problem description into testable research hypotheses
- PSO3 : Select appropriate statistical tools to investigate a research hypothesis.
- PSO4 : Perform data analysis by apply appropriate statistical methodology and interpret result in a variety of settings
- PSO5 : Compute statistical measures using software and programs.

A. G & S. G Siddhartha Degree College of Arts and Science (Autonomous), Vuyyuru

(An Autonomous College in the jurisdiction of Krishna University, Machilipatnam)

NAAC recredited at 'A' level

Autonomous -ISO 9001 – 2015 Certified

Title of the Paper: DESCRIPTIVE STATISTICS AND THEORY OF PROBABILITY

Semester: I

Course Code	STATIIB	Course Delivery Method	Class Room / Blended Mode - Both
Credits	4	CIA Marks	30
No. of Lecture Hours / Week	4	Semester End Exam Marks	70
Total Number of Lecture Hours	60	Total Marks	100
Year of Introduction :2021-22	Year of Offering: 2021 - 22	Year of Revision: ----	Percentage of Revision: 0%

SEMESTER- I

PAPER - I

No of Credits: 4

S. No	PROGRAMME OUTCOMES
PO1	Remember the basic concepts of statistics at different levels and to understand them for gaining of knowledge.
PO2	Apply the statistical techniques in the analysis of data and also acquire knowledge in optimization techniques.
PO3	Facilitate students to acquire flair knowledge to estimate the values in real life problems.

COURSE OUTCOMES

CO.N O	Upon successful completion of this course, students should have the knowledge and skills to:	Mapping
CO1	knowledge of various types of data, their organization and evaluation of summary measures such as non- central and central moments, measures of skewness and kurtosis.	BTL2, PO2
CO2	knowledge to conceptualize the probabilities of events including frequentist and axiomatic approach. simultaneously, they will learn the notion of conditional probability including the concept of Bayes' Theorem,	BTL3, PO2
CO3	knowledge related to concept of discrete and continuous random variables and their probability distributions including expectation and moments,	BTL4, PO2
CO4	knowledge related to concept of generating functions and weak law of large numbers.	BTL4, PO2

About this Course

Statistics is an important field of math that is used to analyze, interpret, and predict outcomes from data. Descriptive statistics will teach you the basic concepts used to describe data. This is a great beginner course for those interested in Data Science, Economics, Psychology, Machine Learning,

Sports analytics and just about any other field. This paper deals with the situation where there is uncertainty and how to measure that uncertainty by defining the probability.

A. G & S. G Siddhartha Degree College of Arts and Science (Autonomous), Vuyyuru
(An Autonomous College in the jurisdiction of Krishna University, Machilipatnam)

STATISTICS	STATIIB	2021-22 Onwards	B.Sc.(MSCs)
-------------------	----------------	------------------------	--------------------

SEMESTER- I

PAPER- I

No. of Credits: 4

DESCRIPTIVE STATISTICS AND THEORY OF PROBABILITY

Unit- I

12L

Moments: Central and non-central moments and their inter-relationships, Sheppard's corrections for moments for grouped data. **Skewness:** Definition, measures of skewness by Karl Pearson's, Bowley's formulae and based on moments. **Kurtosis:** Definition, measures of kurtosis based on moments, Simple problems.

Unit- II

12L

Probability-I: Definitions of various terms - Random experiments, trial, sample space, mutually exclusive, exhaustive, equally likely, favourable and independent events. Definitions- Mathematical, Statistical and Axiomatic definitions of probabilities. Law of addition of probabilities for two events and extension of general law of addition of probabilities. Boole's inequality for n events and real-life problems.

Unit -III

12L

Probability-II : Conditional Probability-Definition - dependent and independence events, multiplication law of probability for two events, extension of multiplication law of probability. Pairwise independent events and conditions for mutual independence of n events and Baye's theorem and its applications and problems.

Unit- IV

12L

Random Variables: Univariate Random variables- Definition, Discrete and Continuous random variables - Probability mass function and probability density function with illustrations. Distribution function and its properties. Bivariate random variables- Definition, Discrete and Continuous bi-variate random variables- joint, marginal and conditional distributions- its properties. Distribution functions of the bivariate random variables and its properties. Independence of random variables, and simple problems.

UnitV:

12L

Mathematical Expectations: Definition, Mathematical expectation of function of a random variable, Properties of Expectations - Addition and Multiplication theorems of expectation. Properties of Variance and Covariance. Cauchy-Schwartz Inequality. Generating Functions- Definition of moment generating function (m.g.f), Cumulant generating function (c.g.f), Probability generating function (p.g.f) and Characteristic function (c.f) and statements of their properties with applications. Chebyshev's inequality and its applications. Statement of Weak Law of Large Numbers for identically and independently distributed (i.i.d) random variables with finite variance.

Text Book: Fundamentals of Mathematical Statistics, 12th Edition, 10th September 2020,
S. C. Gupta and V. K. Kapoor, Sultan Chand & Sons, New Delhi.

Recommended References books:

1. B.A/B.Sc. First Year Statistics(2010), Telugu Academy, Hyderabad.
2. Mathematical Statistics with Applications, 2009, K.M.Ramachandran and Chris P.Tsokos Academic Press(Elsevier), Haryana.
3. Probability and Statistics, Volume I, D.Biswas, New central book Agency (P) Ltd, New Delhi.
4. An outline of Statistical theory, Volume Two, 3rd Edition, 2010 (with corrections) A.M.Goon, M.K. Gupta, B.Dasgupta, The World Press Pvt.Ltd., Kolakota.
5. Sanjay Arora and Bansilal: New Mathematical Statistics, SatyaPrakashan, New Delhi.

Websites of Interest:

<http://onlinestatbook.com/rvls/index.html>

Co-Curricular Activities in the class:

1. Pictionary
2. Case Studies on topics in field of statistics
3. Snap test and Open Book test
4. Architectural - To be build the procedures
5. Extempore - Random concept to students
6. Interactive Sessions
7. Teaching through real world examples

A. G & S. G Siddhartha Degree College of Arts and Science (Autonomous), Vuyyuru
(An Autonomous College in the jurisdiction of Krishna University, Machilipatnam)
NAAC recredited at 'A' level

Autonomous -ISO 9001 – 2015 Certified

COURSE-I, DESCRIPTIVE STATISTICS AND THEORY OF PROBABILITY

B.Sc STATISTICS MODEL PAPER (W.E.F 2022 – 2023)

Time: 3Hrs

Max.Marks:70M

Answer the following questions.

5 x 14 = 70M

Section A

1. (a) 4m
(or)
(b) 4m
2. (a) 4m
(or)
(b) 4m
3. (a) 4m
(or)
(b) 4m
4. (a) 4m
(or)
(b) 4m
5. (a) 4m
(or)
(b) 4m

Section B

1. (a) 10m
(or)
(b) 10m
2. (a) 10m
(or)
(b) 10m
3. (a) 10m
(or)
(b) 10m

4. (a) 10m
(or)
(b) 10m
5. (a) 10m
(or)
(b) 10m

A. G & S. G Siddhartha Degree College of Arts and Science (Autonomous), Vuyyuru
(An Autonomous College in the jurisdiction of Krishna University, Machilipatnam)

STATISTICS	STATIIB	2021-22 Onwards	B.Sc.(MSCs)
-------------------	----------------	------------------------	--------------------

SEMESTER-I

Practical - I: Descriptive Statistics

No of Credits: 1

CO.NO	Upon successful completion of this course, students should have the knowledge and skills to:	Mapping
CO1	draw the suitable diagram and graphs of the givensample data	P02
CO2	Analyze the uni-variate data using statisticaltechniques.	P02

List of Practicals

1. Diagrams & Graphs- Bar, Pie , Histogram, frequency polygon, and Ogive curves
2. Computation of measures of central tendency- Arithmetic Mean, Geometric mean and Harmonic Mean - Grouped Data.
3. Computation of measures of central tendency- Median, Mode and Partition Values - Grouped Data.
4. Computation of measures of Dispersion - Quartile Deviation, Mean Deviation, Standard Deviation, Variance and Coefficient of Variation - Grouped Data.
5. Computation of non-central, central moments, μ_1 and μ_2 and Sheppard's corrections for grouped data.
6. Computation of central moments, μ_1 and μ_2 and Sheppard's corrections when non -central moments are given.
7. Computation of Karl Pearson's coefficients, Bowley's coefficients of Skewness and coefficients of skewness based on moments - Grouped Data

Note: Training shall be on establishing formulae in Excel cells and derive the results. The excel output shall be exported to MS word for writing inference.

Reference Books

1. Practical Manual -Prepared by the Department Faculty Members
2. K.V.S. Sarma: Statistics Made Simple: Do it yourself on PC. PHI

Websites of Interest: <http://www.statsci.org/datasets.html>

A. G & S. G Siddhartha Degree College of Arts and Science (Autonomous), Vuyyuru
(An Autonomous College in the jurisdiction of Krishna University, Machilipatnam)
Reaccredited at 'A' level by NAAC
Autonomous -ISO 9001 – 2015 Certified

Offered to: B.SC (MSCs) / STAT31C STATISTICAL INFERENCE **Course Type:** Core
 (Theory)

Year of Introduction: 2022

Year of Revision: 2022

Percentage of Revision: 0%

Semester: III

Paper No. : III

Credits: 4

Hours Taught: 60 periods. per Semester

Max. Time: 3 Hours

Course Prerequisites (if any): Student required basic knowledge in Probability and Distribution Theory

Course Description:

This course helps the students to familiarize with the ways in which we talk about uncertainty and estimate their situations in which probability arises. Also this course aims at providing basic knowledge about theoretical and application to test according to situations.

Course Objectives:

- 1) To describe many of the important estimation methods and characteristics of the estimators.
- 2) To understand the problem of statistical inference with specific reference to point estimation and interval estimation.
- 3) To differentiate between large and small samples and apply apt testing procedures.

Learning Outcomes: At the end of the course, the student will

- 1) Students will understand the distinguish between the parametric and Non Parametric situations.
- 3) The parameters describe an underlying physical setting in such a way that their value affects the distribution of the measured data..

S. No	Program Outcomes
PO1.	Effective Communication: Speak, read, write and listen clearly in person and through electronic media in English and in one Indian language, and make meaning of the world by connecting people, ideas, books, media and technology
PO2.	Effective Citizenship: Demonstrate empathetic social concern and equity centered national development, and the ability to act with an informed awareness of issues and participate in civic life through volunteering.
PO3.	Ethics: Recognize different value systems including your own, understand the moral dimensions of your decisions, and accept responsibility for them.
PO4.	Environment and Sustainability: Understand the issues of environmental contexts and sustainable development
PO5.	Critical Thinking: Take informed actions after identifying the assumptions that frame our thinking and actions, checking out the degree to which these assumptions are accurate and valid, and looking at our ideas and decisions (intellectual, organizational, and personal) from different perspectives.

PO6:	Specialized Skills / Transferable Skills: Acquisition of communication and soft, analytical and technological skills that aid in enhancing
PO7.	Self-directed and Life-long Learning: Acquire the ability to engage in independent and life-long learning in the broadest context socio-technological changes

Course Outcomes:		
Course Outcome		Program Outcomes Mapping
CO 1	Upon successful completion of this course, students should have the knowledge and skills to: Obtain the knowledge on Exact sampling distributions and their application towards real world examples	PO - 5
CO 2	knowledge of point and interval estimation procedures and different methods of point estimation	PO - 6
CO3	Obtain the knowledge on various testing hypothetical statements and finding Uniformly Most Powerful Test	PO - 6
CO 4	a fundamental understanding of Parametric models for developing relevant inferences on associated parameters large and small samples.	PO - 6
CO 5	To obtain the knowledge and to know the applications of various Non-Randomized tests	PO - 6

Syllabus STATISTICAL INFERENCE

Course Details

Unit	Learning Units	Lecture Hours
I	Exact Sampling Distributions Concepts of Population, Sample, Parameter, Statistic, Sampling distribution, Standard error. law of large numbers, central limit theorem (statements only). Student's t- distribution, F – Distribution, χ^2 - Distribution: Definitions, properties and their applications.	9
II	Theory of estimation Introduction, criteria of a good estimator – unbiasedness, consistency, efficiency, & sufficiency. Statement of Neyman's factorization theorem. Estimation of parameters by the method of moments and maximum likelihood (M.L), properties of MLE's (statements only). Binomial, Poisson & Normal population parameters estimate by MLE method. Interval estimation – construction of confidence intervals for population mean using normal distribution.	15
III	Testing of Hypothesis Concepts of Statistical hypotheses, Null and Alternative hypothesis, Critical region, Type I and II errors, level of significance and Power of a test. One and two tailed tests, p-value. Neyman-Pearson's lemma. Examples in case of Binomial, Poisson, Exponential and Normal distributions.	12

IV	<p>Large sample Tests Test for single mean and difference of two means, test for single proportion and difference of proportions. Simple Problems.</p> <p>Small Sample tests - I t-test for single mean, difference of means and paired t-test. F-test for equality of population variances. Simple Problems.</p>	12
V	<p>Small Sample tests - II χ^2-test for goodness of fit and independence of attributes Non – Parametric Tests Non-parametric tests- Advantages and Disadvantages, Measurement scales - Nominal, Ordinal, Interval and Ratio. One sample tests – Sign and Run test. Two sample tests - Median test, Wilcoxon–Mann-Whitney U test, Kruskal – Wallis test or H- test, Run test. Simple Problems.</p>	12

Text Book:

Fundamentals of Mathematical Statistics, 11th Edition, 2010, S. C. Gupta and V. K. Kapoor, Sultan Chand & Sons, New Delhi

Reference Books:

1. B.A/B.Sc. Second Year Statistics(2010) , Telugu Akademi, Hyderabad.
2. Mathematical Statistics with Applications, 2009, K.M.Ramachandran and Chris P.Tsokos Academic Press(Elsevier), Haryana .
3. Probability and Statistics, Volume I & II, D. Biswas, New central book Agency (P) Ltd, New Delhi.
4. An outline of Statistical theory, Volume II, 3rd Edition, 2010 (with corrections) A.M. Goon, M.K. Gupta, B. Dasgupta, The World Press Pvt. Ltd., Kolakota. Sanjay Arora and Bansi Lal. New Mathematical Statistics, Satya Prakashan, New Delhi.

A. G & S. G Siddhartha Degree College of Arts and Science (Autonomous), Vuyyuru
(An Autonomous College in the jurisdiction of Krishna University, Machilipatnam)
Reaccredited at 'A' level by NAAC
Autonomous -ISO 9001 – 2015 Certified

Model Question Paper Structure for SEE

Max.: 75 Marks

Min.Pass: 30 Marks

**Statistical
InferenceSection –
A**

Answer any FIVE of the following

5 x 5M = 25Marks

1. Write the statements of Weak Law of large numbers and Central limit theorem.
2. Define F-distribution and write its applications.
3. Prove that sample mean is an unbiased and consistent estimator of population mean.
4. Define the following terms:
(i) Null hypothesis (ii) Alternative hypothesis (iii) critical region.
5. Explain Type I and Type II errors.
6. Write the procedure for single mean in large sample tests.
7. Write the procedure of F-test for equality of population variances.
8. Explain the procedure of Sign test for single mean.

Section – B

Answer ALL questions

5 x 10M = 50Marks

9. a. Define student's t-distribution. Write its applications and their properties.
(OR)
b. Define chi-square distribution. Write its applications and their properties.
10. a. Explain the characteristics of a good estimator
(OR)
b. Find Maximum likelihood estimator for μ and σ^2 in normal population.
11. a. State and prove Neyman-Pearson's lemma.
(OR)
b. If $x \geq 1$ is the critical region for testing $H_0: \theta = 2$ vs $H_1: \theta = 1$ on the basis of the single observation from an exponential distribution with probability density function $f(x, \theta) = \theta e^{-\theta x}$. Obtain the value of Type I and Type II errors.
12. a. In a Survey of buying habits, 400 women shoppers are chosen at random on supermarket 'A' located in a certain section of the city. Their average weekly food expenditure is Rs.250 with a S.D. of Rs. 40. For 400 women shoppers are chosen at random on Supermarket 'B' in another section of the city, the average weekly food expenditure is Rs.220 with a S.D. of Rs 55. Test at 1% level of significance whether the average weekly food expenditure of the populations of shoppers are equal.
(OR)
b. Explain the procedure of t- test for difference of means.

13. a. Out of 8,000 graduates in a town 800 are females, out of 1,600 graduate employees 120 are females. Use χ^2 to determine if any distinction is made in appointment the basis of sex.

(O
R)

- b. Explain the procedure of Wald-Wolfowitz run test for two samples.

A. G & S. G Siddhartha Degree College of Arts and Science (Autonomous), Vuyyuru
(An Autonomous College in the jurisdiction of Krishna University, Machilipatnam)
Reaccredited at 'A' level by NAAC
Autonomous -ISO 9001 – 2015 Certified

Offered to: B.SC (MSCs) / STAP31C

Course Type: Core (Practical)

Year of Introduction: 2022

Year of Revision: 2022

Percentage of Revision: 0%

Semester: III

Paper No. III

Credits: 1

Hours Taught: 30 periods. per Semester

Max.Time: 2 Hours

Course Prerequisites (if any): Student required basic knowledge in computers

Course Description:

This course gives a working knowledge of Excel to students with the aim of getting to use dataanalysis and testing.

Course Objectives

- 1) To train students in SPSS Software
- 2) To expose the students to the analysis of statistical data and comparing data sets.

Learning Outcomes: At the end of the course, the student will

- 1) able to do data analysis using Excel
- 2) known to choose the data to test various types.

S. No	Programme Outcomes
PO1.	Effective Communication: Speak, read, write and listen clearly in person and through electronic media in English and in one Indian language, and make meaning of the world by connecting people, ideas, books, media and technology
PO2.	Effective Citizenship: Demonstrate empathetic social concern and equity centred national development, and the ability to act with an informed awareness of issues and participate in civic life through volunteering.
PO3.	Ethics: Recognize different value systems including your own, understand the moral dimensions of your decisions, and accept responsibility for them.
PO4.	Environment and Sustainability: Understand the issues of environmental contexts and sustainable development
PO5.	Critical Thinking: Take informed actions after identifying the assumptions that frame our thinking and actions, checking out the degree to which these assumptions are accurate and valid, and looking at our ideas and decisions (intellectual, organizational, and personal) from different perspectives.
PO6:	Specialized Skills / Transferable Skills: Acquisition of communication and soft, analytical and technological skills that aid in enhancing
PO7.	Self-directed and Life-long Learning: Acquire the ability to engage in independent and life-long learning in the broadest context socio-technological changes

Course Outcomes:		
Course Outcome	Upon successful completion of this course, students should have the knowledge and skills to:	Programme Outcomes Mapping
CO 1	To Apply statistical analysis that can test hypotheses under parametric approaches.	PO –6
CO 2	To Apply statistical analysis that can test hypotheses under non-parametric approaches.	PO –6

List of practical's

1. Small sample test (t-test): One Sample, Independent Sample and Paired Sample.
2. Large sample tests: One Sample, Independent Sample, Paired Sample (Using Excel)
3. Small sample test (F-test): Equality of population variances (Using Excel)
4. Chi square Test: Test of Independence
5. Chi square Test: Goodness of fit
6. Chi square Test: Test of Independence, 2X2, 3X3,..., mXn Cross tabulation (Using Excel)
7. Non Parametric Tests: Mann Whitney U test and Wilcoxon Signed ranks test
8. Non Parametric Tests: Kruskal Wallis Test and Friedman test (Using Excel)

**A.G& S.G.SIDDHARTHA DEGREE COLLEGE OF ARTS &
SCIENCE**

VUYYURU-521165, KRISHNA Dt., A.P.(Autonomous)

Accredited by NAAC with "A" Grade

2022-2023



DEPARTMENT OF TELUGU

MINUTES OF BOARD OF STUDIES

ODD SEMESTER

25-10-2022

A.G & S.G.Siddartha Degree College of Arts & Science,(AUTONOMOUS)
VUYYURU – 521 165, Krishna District
(An Autonomous College in the jurisdiction of Krishna University, Machilipatnam, A.P.India
Accredited at 'A' NACC

తెలుగు విభాగం పాఠ్య నిర్ణాయక మండలి (బోర్డు ఆఫ్ స్టడీస్) సమావేశం - 14

తేది.25-10-2022 ఉదయం 10 గంటలకు అడుసుమిల్లి గోపాలకృష్ణయ్య చెఱకు రైతుల సిద్ధార్థ డిగ్రీ కళాశాల ఉయ్యూరు, తెలుగు కాబల్ 2022-2023 విద్యా సంవత్సరానికి తెలుగు శాఖ అధ్యక్షురాలు శ్రీమతి ఎమ్.ఎల్.యస్. కుమారి అధ్యక్షతన సమావేశం నిర్వహించటం జరిగినది.

తెలుగు పాఠ్యాంశ నిర్ణాయక మండలి సమావేశానికి చర్చనీయాంశాలు.

1. 2022-2023 విద్యా సంవత్సరంలో ప్రథమ, ద్వితీయ బి.ఎ., బి.కాం., బి.ఎస్.సి తరగతులకు మొదటి, మూడవ సెమిస్టర్లకు సంబంధించిన పాఠ్యాంశాల నిర్ణయం గురించి.
2. అధ్యక్షురాలు అనుమతితో ఇతర అంశాలు ఏమైనా.....

తీర్మానాలు:

తేది.21-10-2022 ఉదయం 10 గంటలకు అడుసుమిల్లి గోపాలకృష్ణయ్య చెఱకు రైతుల సిద్ధార్థ డిగ్రీ కళాశాల ఉయ్యూరులో 2022 -2023 విద్యా సంవత్సరానికి రెండవ భాషగా తెలుగు పాఠ్యాంశాలు నిర్ణయించిన తరువాత తెలుగు పాఠ్య నిర్ణాయక మండలి (బోర్డు ఆఫ్ స్టడీస్) సభ్యులు ఈ క్రింది తీర్మానాలను ఏకగ్రీవంగా ఆమోదించడమైనది.

1. 2022-2023 విద్యా సంవత్సరం ప్రథమ, తృతీయ సెమిస్టర్ పాఠ్యాంశాలలో ఎటువంటి మార్పులేదని అనగా 2021- 2022లో వున్న పాఠ్యాంశాలనే ఉంచాలని తీర్మానించడమైనది.
2. 2022 -2023 విద్యా సంవత్సరం ప్రథమ బి.ఎ., బి.కాం., బి.ఎస్.సి ప్రశ్న పత్రం ఎక్స్ టర్నల్ 70 మార్కులకు, ఇంటర్నల్ 30 మార్కులకు ఇవ్వాలని, ద్వితీయ బి.ఎ., బి.కాం., బి.ఎస్.సి మూడవ సెమిస్టరుకు ప్రశ్న పత్రం ఎక్స్ టర్నల్ 75 మార్కులకు, ఇంటర్నల్ 25 మార్కులకు ఇవ్వాలని తీర్మానించడమైనది.
3. 2022 -2023 విద్యా సంవత్సరం ప్రథమ, ద్వితీయ బి.ఎ.,బి.కాం., బి.ఎస్ సి విద్యార్థులకు కనీస పాస్ మార్కులు లేవని తీర్మానించడమైనది.

హాజరైన సభ్యులు:-

1. శ్రీమతి ఎం.ఎల్.యస్ కుమారి M. L. S. *Cumari*
తెలుగు శాఖ అధ్యక్షురాలు, పాఠ్య నిర్ణాయక మండలి అధ్యక్షురాలు.
2. శ్రీమతి బి.ఎస్.ఎల్ పద్మశ్రీ
తెలుగు శాఖ అధ్యక్షురాలు
ఎస్.పి. మహిళ కళాశాల, మచిలీపట్నం
(కృష్ణా విశ్వవిద్యాలయ నామిని)
3. డాక్టర్.జి.శ్రీనివాస్ G. S. *Ullas*
తెలుగు శాఖ అధ్యక్షులు
ప్రభుత్వ డిగ్రీ కళాశాల
చింతలపూడి
విషయం నిపుణులు (Subject Expert)
4. శ్రీమతి.జి.జ్యోతి G. *Jyothi*
తెలుగు అధ్యాపకురాలు
5. శ్రీమతి.పి కాశీ విశ్వేశ్వరి
విద్యార్థి ప్రతినిధి.

TELUGU	TELT11A	2022-2023	B.A., B.Com., B.B.A., B.B.A.-Ana, B.Com.-CA, B.C.A., & B.Sc.,
--------	---------	-----------	--

SEMESTER-I

CREDITS - 3

TELUGU-I

యూనిట్-I రాజనీతి - నన్నయ మహాభారతము - సభాపర్వం - ప్రథమాశ్వాసంలో 26వ పద్యము "మీవంశమున..... నీవు వారిచైన నేర్పెటింగి" నుండి 57వ పద్యము "నాయధాశక్తి వాని ననుష్ఠితు వ్రీయముతోడ" వరకు.

యూనిట్-II దక్షయజ్ఞం - నన్నెచోడుడు కుమార సంభవం - ద్వితీయాశ్వాసంలో 49వ వచనం "అంతరమున్ను..... ధయంరకాచారంబుదాల్చిన" నుండి 86వ పద్యం "ప్రమథగణము.... కనిరిశంభు" వరకు.

యూనిట్-III ధామ్యధర్మోపదేశము - తిక్కన మహాభారతము - విరాటపర్వము - ప్రథమాశ్వాసంలో 116వ పద్యం "ఎఱిగెడు వారిచినైనను.....వలయు దగియెడు ముద్దులో" నుండి 146వ పద్యం "అతడు నియతితోడ..... సంవయములు దగ ఆపించుచుండె" వరకు.

యూనిట్-IV కుదుర స్నేహం - పోతన ఆంధ్రమహాభాగవతము - దశమస్కంధము - కుచోలోపాఖ్యానంలో 962వ పద్యం "లలిత పతివ్రతాతిలకంబు..... కుపాయమూహింప వైతి" నుండి 983వ పద్యం "తన మృదుతల్పమందు..... ధరణీసురు దెంతటి భాగ్యవంతుడో" వరకు.

యూనిట్-V నీతారావణ సంవాదం - మొల్ల రామాయణము - సుందరకాండములో 40వ వచనం "అరామంజూచి.... వృక్షం బారోహించి యందు" నుండి 87వ పద్యం "చావున నిక్కోమలియెడ..... మనకు దిక్కగు మీదన్" వరకు.

వ్యాకరణము :

1. సంధులు:- సవర్ణ, గుణ, యణాదేశ, వృద్ధి, అచార, ఇచార, ఉచార, త్రిక సంధులు.
2. సమాసములు:- తత్పరుష, కర్మధారయ, ద్వుంద్వ, ద్విగు, బహువ్రీహి సమాసములు.
3. ఛందస్సు:- వృత్త పద్యాల్లో ఉత్పలమాల, చంపకమాల, శార్దూలము, మత్తేధము. జాతులు, ఉపజాతుల్లో కందము, శేటగీతి, ఆటవెలది మరియు ముత్యాలసరాలు.
4. అలంకారములు:- శబ్దాలంకారాల్లో అనుప్రాసాలైన వృత్తనుప్రాస, ఛేదానుప్రాస, లాటానుప్రాస, అంత్యానుప్రాసములు. అర్థాలంకారాల్లో ఉపమ, ఉత్పేక్ష, రూపక, క్షేపణలు.

TELUGU	TELTIA 2022 - 2023 I B.A., B.Com., B.Sc	Semester-I
--------	--	------------

I SEMESTER - MODEL PAPER

- I. క్రింది వానిలో ఒకదానికీ ప్రతి పదార్థ తాత్పర్యమును వ్రాయండి. 1 X 10 = 10మా
1. బహుదనదాస్య సంగ్రహము బాణకరాసన యోధవీర సం
 గ్రహము నిరంతరాంతరుదకంబులు మాసంసేందనామ సం
 గ్రహము ననేక యంత్రములు గల్గియసాధ్యములై ద్విపద్మయా
 వహు లగుచుండ నొప్పునె బవత్పరి రక్ష్యములైన దుర్గముల్.
 2. కలలోనందను మున్నెరుంగని మహా కష్టాత్ముడై నట్టి దు
 ర్వులు దాపత్వమయంబునన్ నిజ పదాజ్ఞాతంబులు ల్లంబులోన్
 దలపన్నంతనే మెచ్చి యార్తి హరుడై తన్నెన నిచ్చున్ సు ని
 శ్చల బక్షిన్ బజియించువారి కిడడే సంపద్విషోన్నతుల్.
- II. క్రింది వానిలో రెండింటికీ సందర్భ సహిత వ్యాఖ్యలు వ్రాయండి.. 2 X 5 = 10మా
1. వార్త నిర్వహింపవలయు బతికి.
 2. నన్ను బనుపు దక్షు బట్టి తెచ్చెదన్.
 3. పురుషార్థంబునకు హాని పుట్టక యున్నే?
- III. క్రింది వానిలో రెండింటికీ సంగ్రహరూప సమాధానాలు వ్రాయండి. 2 X 5 = 10మా
1. రాజు చేయకూడని పనుల్ని తెలపండి.
 2. ప్రమదులు దక్షుని బందించిన తరును తెల్పండి.
 3. దొమ్ముని ఉపదేశానంతరం ఏమి జరిగింది?
- IV. ఈ క్రింది వానికీ వ్యాసరూప సమాధానాలు వ్రాయండి. 2 X 10 = 20మా
1. ప్రజా పాలనలో రాజులు పాటించాల్సిన దర్మాలేవి ?
 (లేదా)
 దక్షయజ్ఞం పాఠ్య సారాంశాన్ని వ్రాయండి.
 2. దొమ్ముడు పాండవులకు చేసిన దర్మోపదేశాన్ని వివరించండి.
 (లేదా)
 మదురస్నాహం పాఠ్యసారాంశాన్ని తెల్పండి.

V. ఈ క్రింది వానిలో మూడింటిని విడదీసి సంధి కార్యం వ్రాయండి

3 X 2 = 6మా

1. శత్రైకవృద్ధి 2. జగమెల్ల 3. మనుజేంద్రుడు 4. కష్టాత్ముడు 5. ఇక్కోమలి

VI. క్రింది వానిలో మూడింటికి విగ్రహవాక్యములు వ్రాసి, సమాస నామములు తెల్పండి.

3 X 2 = 6మా

1. అష్టాగాలు 2. ఆశ్రయము 3. భీమార్జునులు 4. మధురస్నేహం. 5. తోయజాక్షి

VII. క్రింది పద్య పాదాన్ని గణ విభజన చేసి, యతిని గుర్తించి ఏ పద్యపాదమో తెల్పండి.

1 X 4 = 4మా

తన మృదుతల్పమందు వనితామణియైన రమాలలామ పొం

(లేదా)

క్రింది వానిలో ఒకదానికి లక్ష్య, లక్షణ సమన్వయం చేయండి

1. తేటగీతి 2. ముత్యాలసరాలు 3. ఆటవెలది

VIII. క్రింది పద్యములోని అలంకారమును గుర్తించి లక్ష్య, లక్షణ సమన్వయం చేయండి.

1 X 4 = 4మా

బాల సఖుడైన యప్పద్మ పతనేత్రు

గాన నేగి దరిద్రాంధకార మగ్ను

లయిన మము నుద్దరింపుము హరి కృపాక

టాక్ష రవిదీప్తి వడసి మహాత్మా! నీవు

(లేదా)

క్రింది వానిలో ఒకదానికి లక్ష్య, లక్షణ సమన్వయం చేయండి.

1. వృత్యనుప్రాసము 2. లాటానుప్రాసము

TELUGU	TELT01A	2021-'22	B.A., B.Com., B.B.A., B.B.A.-Ana, B.C.A., & B.Sc.,
--------	---------	----------	---

SEMESTER-III/౩ :

TELUGU-III

Credits - 3

పాఠ్య ప్రణాళిక

యూనిట్-1

వ్యక్తీకరణ నైపుణ్యాలు

1. భాష-ప్రాథమికాంశాలు:- భాష-నిర్వచనం, లక్షణాలు, ఆవశ్యకత, ప్రయోజనాలు.
2. 'వర్ణం-పదం-వాక్యం', వాక్య లక్షణాలు, సామాన్య-సంయుక్త-సంశ్లిష్ట వాక్యాలు.
3. భాషా నిర్మాణంలో 'వర్ణం-పదం-వాక్యం' ప్రాధాన్యత.

యూనిట్-II

సృజనాత్మక రచన

4. కవితా రచన:- ఉత్తమ కవిత - లక్షణాలు.
5. కథా రచన:- ఉత్తమ కథ - లక్షణాలు.
6. వ్యాస రచన:- ఉత్తమ వ్యాసం - లక్షణాలు.

యూనిట్-III

అనువాద రచన

7. అనువాదం:- నిర్వచనం, అనువాద పద్ధతులు.
8. అనువాద సమస్యలు:- భౌగోళిక, భాషా, సాంస్కృతిక సమస్యలు, వరిష్కారాలు.
9. అభ్యాసము:- ఆంగ్లం నుండి తెలుగునకు ఒక పేరాను అనువదించడం.

యూనిట్-IV

మాధ్యమాలకు రచన-I:- ముద్రణ / ప్రింట్ మీడియా

10. ముద్రణా మాధ్యమం / అచ్చు :- పరిచయం, పరిధి, వికాసం.
11. వివిధ రకాల పత్రికలు - పరిశీలన, పత్రికా భాష, శైలి, వైవిధ్యం.
12. పత్రికా రచన:- వార్తా రచన, సంపాదకీయాలు, సమీక్షలు - అవగాహన.

యూనిట్-V

మాధ్యమాలకు రచన-II:- వ్రసార మాధ్యమం / ఎలక్ట్రానిక్ మీడియా

13. వ్రసార మాధ్యమాలు:- నిర్వచనం, రకాలు, విస్తృతి, ప్రయోజనాలు.
14. శ్రవణ మాధ్యమాలు-రచన:- రేడియో రచన, ప్రసంగాలు, నాటికలు, వ్రసార సమాచారం.
15. దృశ్య మాధ్యమాలు-రచన:- వ్యాఖ్యానం / యాంకరింగ్, టెలివిజన్ రచన.

AG & SG SIDDHARTHA DEGREE COLLEGE OF ARTS & SCIENCE VUYURU
(AUTONOMOUS)

SEMESTER-END EXAMINATIONS, NOVEMBER-2021

సమాచార ప్రశ్నపత్రం

Max. Marks: 75M

Pass Min. : 30M

Course Code: TEL TD1A (Telugu-III)
Time: 3 Hrs.

అ-భాగం

I. త్రింది వానిలో ఒదింటికి నల్గపూరూవ నమూనాలు వ్రాయండి. ఎదిమిరవ ప్రశ్నకు నమూనానం
కవ్వదివరగా వ్రాయండి. $5 \times 5 = 25$

1. లావ - ప్రయోజనాలు.

2. ఉత్తమ వ్యాసం - లక్షణాలు.

3. అనువార సమస్యలు

4. సంపాదకీయాలు

5. దివిదివి రచన.

6. ఉత్తమ కథ - లక్షణాలు.

7. సమీక్షలు - అచూపాన.

8. త్రింది అంశాన్ని సుడికారం చెడకుండా తెలుగులోకి అనువదించండి.

To many, Indian thought, Indian manners, Indian customs, Indian philosophy, Indian literature are repulsive at the first sight, but let them preserve, let them read, let them become familiar with the great principles underlying these ideas, and it is ninety-nine to one that the charm will come over them, and fascination will be the result. Slow and silent, as the gentle dew that falls in the morning, unseen and unheard yet producing, a most tremendous result, has been the work of the calm, patient, all-suffering spiritual race upon the world of thought.

అ-భాగం

II. త్రింది వానిలో ఒదింటికి వ్యాసరూవ నమూనాలు వ్రాయండి: $5 \times 10 = 50$

9. లాపా విరూపాక్షంలో వర్ణం-వరం-వాక్యాలు ప్రారావ్యతను వివరించండి.

10. ఉత్తమ కవితా లక్షణాలను విశ్లేషించండి.

11. అనువార లక్షణాలను తెర్చి, వర్ణనాలను రాయండి.

12. ముఖ్యంగా మార్గమూర్తి వివరించి, లావి ఎదిటి వికాసాలను తెల్పుము.

13. యాంకరింగ్ నిర్వహణ, రీడు తెప్పిర్చి తెల్పండి.

14. పులికా లావ - కై - సైవిరూపి వివరింపుము.

15. సామాన్య-సంయుక్త-సంక్లిష్ట వాక్యాలను వివరింపుము.

16. ప్రాసార మార్గమూల విస్ఫులి, ప్రయోజనాలను సమీక్షించండి.

...

TELUGU	TELT01A	2021-'22	B.A., B.Com., B.B.A., B.B.A.-Ana, B.C.A., & B.Sc.,
--------	---------	----------	---

ప్రశ్నపత్ర నిర్మాణ సూచిక:

అ-భాగం

సంక్షిప్త రూప ప్రశ్నలు :

5 × 5 = 25మా

ప్రతి యూనిట్ నుండి తప్పనిసరిగా ఒక ప్రశ్న ఇచ్చి, మొత్తం మీద ఎనిమిది ప్రశ్నలు ఇవ్వాలి. అందులో ఐదంటికి సమాధానాలు వ్రాయవలసి. ఎనిమిదవ ప్రశ్నకు తప్పనిసరిగా సమాధానం రాయాలి.

అ-భాగం

వ్యాసరూప ప్రశ్నలు :

5 × 10 = 50మా

ప్రతి యూనిట్ నుండి తప్పనిసరిగా ఒక ప్రశ్న ఇచ్చి, మొత్తం మీద ఎనిమిది ప్రశ్నలు ఇవ్వాలి. అందులో ఐదంటికి సమాధానాలు వ్రాయవలసి.

**A.G& S.G.SIDDHARTHA DEGREE COLLEGE OF ARTS & SCIENCE
VUYYURU-521165, KRISHNA Dt., A.P. (Autonomous)**





**Accredited by NAAC with “A” Grade
2022-23**



**DEPARTMENT OF ZOOLOGY
MINUTES OF BOARD OF STUDIES
ODD SEMESTER
22-10-2022**

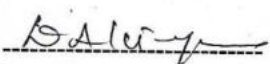
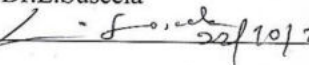
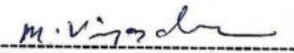

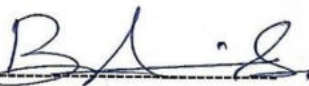
Minutes of the meeting of Board of studies in Zoology for the Autonomous courses of AG & SG Siddhartha Degree College of Arts & Science, Vuyyuru, held at 3:00 pm on 22-10-2022 in the Department of Zoology.

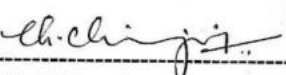
S.No	Name	Designation	signature
1.	Smt. D.A.Kiranmayee Head, Department of Zoology A.G&S.G.S Degree College Vuyyuru	Chair person	 D.A.Kiranmayee
2	Smt. Dr.L.Suseela Bio Sciences & Bio technology Krishna University Machilipatnam.	University Nominee	----- Dr.L.Suseela  22/10/22
3.	Sri Dr.M.Vijay kumar Head, Department of Zoology SRR & CVR Govt. Degree College, Vijayawada.	Subject Expert	 Dr.M.Vijay kumar
4.	Sri Ch. Venkateswaralu, Head, Department of Zoology, P.B. Siddhartha College, Vijayawada.	Subject Expert	 Ch. Venkateswaralu,
5.	Sri.B. Appala Naidu, Asst. Project Manager, RGCA Manikonda.	Industrialist	 B. Appala Naidu,
6.	Smt. K. Padmaja, Lecturer in Zoology, A.G&S.G.S Degree College Vuyyuru-	Member	 K. Padmaja,
7	Smt. Dr.V.Subhashini, Lecturer in Zoology, A.G & S.G.S Degree College Vuyyuru-	Member	 Dr.V.Subhashini
8	Sri.Ch.Chiranjeevi, P.hd –Research Scholar, Dept.of Botany & Microbiology, Acharya Nagarjuna University Guntur.	Student Represent	 Ch.Chiranjeevi,

ZOOLOGY

Agenda for B.O.S Meeting.

1. To recommend the syllabi (Theory & Practical), Model question paper for I Semester of IB.Sc (B.Z.C) for the academic year 2022 - 2023.
2. To recommend the syllabi (Theory & Practical), Model question paper for III Semester of II B.Sc (B.Z.C) for the academic year 2022 - 2023.
3. To introduce Skill enhancement course the syllabi (Theory & Practical), Model question paper for VSemester of IIIB.Sc (B.Z.C) for the academic year 2022 - 2023.
4. To recommend the Blue print for the semester end exam for I, III & V semester of I, II, III B.Sc (B.Z.C) for the academic year 2022 - 2023.
5. To introduce LifeSkill Course – Health and Hygiene for II year students in this academic year 2022-23.
6. To introduce Value added course (Theory, Model question paper) for VSemester of III B.Sc(B.Z.C) for the academic year 2022 - 2023.
7. To recommend the teaching and evaluation methods to be followed under Autonomusstatus.
8. Any other matter.

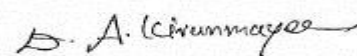

Chairman.

ZOOLOGY- RESOLUTIONS

1. It is resolved to continue the same syllabi (Theory & Practical), model question paper & guide lines to be followed by the question paper setters of Zoology of I semester of I B.Sc. (B.Z.C) under Choice Based Credit System (CBCS) approved by the Academic Council of 2022 – 2023.

2. It is resolved to follow the changed syllabi (Theory & Practical), model question paper & guide lines to be followed by the question papers under Choice Based Credit System (CBCS) setters of Zoology of III Semester of II B.Sc. (B.Z.C) for approval by the Academic Council of 2022 –2023. The new paper introduced is Cell Biology, Cellular Metabolism, Genetics, Organic Evolution and Animal Behaviour

3. It is resolved to implement the new syllabi & model papers under Choice Based Credit System (CBCS) of Zoology of V semester SEC – 6 (Sustainable Aquaculture Management) and SEC – 7A(Postharvest Technology of fish and Fisheries) of III B.Sc. (B.Z.C) approved by the Academic Council of 2022-2023.

4. It is resolved to continue the same Blue prints of I, III, & V Semesters of B.Sc Zoology for the Academic year 2022-2023.

5. It is resolved to implement Life Skill Course for II-year students. of III SEM

6. It is resolved to implement Value added Course for III-year students of V SEM

7. It is resolved to continue the following teaching & evaluation methods for the year 2022-23.

Teaching methods:

Besides the conventional methods of teaching, we use modern technology i.e. Using of OHP and LCD projector to display on U boards etc; for better understanding of concepts.

Evaluation of a student is done by the following procedure:

❖ Internal Assessment Examination:

- ❖ Out of maximum 100 marks in each paper for I, II B.Sc, 30 marks shall be allocated for internal assessment.
- ❖ Out of these 30 marks, 20 marks are allocated for announced tests (i.e . IA-1& IA-2). Two announced tests will be conducted and average of these two tests shall be deemed as the marks obtained by the student, 5 marks are allocated on the basis of candidate's percentage of attendance and remaining 5 marks are allocated for the assignment for I, III B.SC.
- ❖ Out of maximum 100 marks in each paper for II B.Sc, 25 marks shall be allocated for internal assessment.
- ❖ Out of these 25 marks, 15 marks are allocated for announced tests (i.e . IA-1& IA-2). Two announced tests will be conducted and average of these two tests shall be deemed as the marks obtained by the student, 5 marks allocated on assignment and remaining 5 marks seminar for III semester. There is no pass minimum for internal assessment for I, II, III B.Sc.

❖ Semester – End Examination:

- ❖ The maximum mark for I&III (BZC) semester – End examination shall be 70 marks and duration of the examination shall be 3 hours.
- ❖ The maximum mark for II B.Sc semester- End examination shall be 75 marks and duration of the examination shall be 3 hours. Even through the candidate is absent for two IA exams / obtain zero marks the external marks are considered (if the candidate gets 40/70) and the result shall be declared as “PASS”
- ❖ Semester – End examination shall be conducted in theory papers at the end of every semester, while in practical papers, these examinations are conducted at the end of I, III, & V semester for I, II & III B.Sc.
- ❖ Discussed and recommended for organizing Value added course, Seminars, Guest lectures, Work – Shops to upgrade the Knowledge of students, for the approval of the Academic Council.

A. C. Srinivasan

❖
❖ Chairman

**ADUSUMILLI GOPALAKRISHNAIAH & SUGAR CANE GROWERS SIDDHARTHA DEGREE COLLEGE OF
ARTS & SCIENCE, VUYYURU-521165, KRISHNA Dt., A.P. (AUTONOMOUS).**

ALLOCATION OF CREDITS

<i>Year</i>	<i>Semester</i>	<i>Title</i>	<i>Teaching hours</i>	<i>Internal marks</i>	<i>External marks</i>	<i>Credits</i>	
I	I	Animal Diversity - I Biology of Non-Chordates	4	25	75	03	
		Animal Diversity -Biology of Non-Chordates - Practical - I	2	10	40	02	
II	III	Cell Biology, Cellular Metabolism, Genetics, Organic Evolution and Animal Behaviour	4	25	75	03	
		Cell Biology, Cellular Metabolism, Genetics, Organic Evolution and Animal Behaviour Practical - III	2	10	40	02	
	III	Health and Hygiene	2	10	40	02	
III	SEC- 6(A) V(501)	SUSTAINABLE AQUACULTURE MANAGEMENT	3	30	70	03	
		Practical - 501p SUSTAINABLE AQUACULTURE MANAGEMENT	3	25	25	02	
	SEC- 7(A) V(502)	POSTHARVEST TECHNOLOGY OF FISH AND FISHERIES	3	30	70	03	
		Practical - 502p POSTHARVEST TECHNOLOGY OF FISH AND FISHERIES	3	25	25	02	
		6B LIVE STOCK MANAGEMENT-I (BIOLOGY OF DAIRY ANIMALS	3	30	70	3	
			Practical paper-6B Biology of Dairy Animals	3	25	25	2
			7B LIVE STOCK MANAGEMENT -II (DAIRY PRODUCTION AND MANAGEMENT)	3	30	70	3
			Practical paper-7B Dairy products and management	3	25	25	2
			POULTRY MANAGEMENT- I (POULTRY FARMING)	3	30	70	3
		POULTRY MANAGEMENT- II (POULTRY PRODUCTION AND MANGEMENT	3	25	25	2	

ADUSUMILLI GOPALAKRISHNAIAH & SUGAR CANE GROWERS SIDDHARTHA DEGREE COLLEGE OF ARTS & SCIENCE, VUYYURU-521165, KRISHNA Dt., A.P. (AUTONOMOUS).

NAAC reaccredited at 'A' level
Autonomous –ISO 9001-2015 Certified

Title of the Paper: **Animal Diversity Biology of Non – Chordates**

Semester: - I

Course Code	ZOOT11A	Course Delivery Method	Class Room/Blended Mode - Both
Credits	3	CIA Marks	30
No. of Lecture Hours/ Week	4	Semester End Exam Marks	70
Total Number of Lecture Hours	60	Total Marks	100
Year of Introduction: 2021-22	Year of Offering 2021-2022	Year of Revision – 2021-22	Percentage of Revision: 0%

AIM

- To know the biodiversity of invertebrates

LEARNING OBJECTIVES

- To understand the structural organization of animals from Protozoa to Hemichordate
 - To understand the evolutionary relationship of different phyla from Protozoa to Hemichordate
 - To understand the specific phenomena exhibited by different groups of invertebrates from Protozoa to Hemichordate
 - To understand the taxonomic position and affinities of certain groups of invertebrates
- AsConnecting links
- To study the life cycles, and pathogenicity of certain

PREREQUISITE

- Knowledge of invertebrates acquired in Intermediate

COURSE OUTCOMES

By the end of the course students will be able to

CO 1 Gain knowledge in the fundamental concepts underlying the structural complexity in the organization of invertebrates.

CO 2 Understand biology and pathogenicity of parasites and their adaptations analyse remedial and preventive measures and promote the same in public domain.

CO 3 Appreciate and evaluate the economic, commercial, medicinal and culture importance of invertebrates and their larval stages in relation to phylogeny

CO 4 Describe the significance of connecting links in understanding the concept of evolution

CO 5 Explain the significance of specific phenomena in different group's of invertebrates in relation to their adaptability for survival

CO 6 Comprehend the systems biology of individual phyla with a specific type study and understand the origin and evolutionary relationship of different phyla and appreciate the uniqueness of individual phyla.

Syllabus
Course Details

Unit	Learning Units	Lecture Hours
I	<p><i>PROTOZOA AND PORIFERA</i> Introduction to Non-chordates – Origin of metazoans Type study: <i>Polystomella</i>(structure and life cycle) Locomotion in protozoans Nutrition in protozoans Type study: <i>Sycon</i>(Structure, histology and skeleton) Canal system in sponges</p>	13
II	<p><i>CNIDARIA AND CTENOPHORA</i> Type study: <i>Obelia</i>. (Structure – polyp and medusa and life cycle) Polymorphism in cnidarians. Corals and coral reefs Ctenophora (structure and affinities)</p>	10
III	<p><i>HELMINTHES AND ANNELIDA</i> Type study: <i>Fasciola hepatica</i> (Structure, reproduction, life cycle and pathogenicity) Parasitic adaptations in helminthes Type study: <i>Ascarislumbricoides</i>(Structure, reproduction, life cycle and pathogenicity) Type study: <i>Hirudineria</i>(Structure, circulatory, excretory and reproductive systems) Coelom and coelomoducts in annelids</p>	17
IV	<p><i>ARTHROPODA AND MOLLUSCA</i> Structural affinities of Onycophora Type study: <i>Macrobrachiumrosenbergii</i>(Structure, appendages and Respiratory system) Economic importance of insects (Beneficial – Lac insect, honey bee, <i>Bombyxmori</i>and Lady bird; Harmful – house fly, mosquito, locustand bedbug) Metamorphosis in insects Study of Pearl Oyster and Pearl Formation Torsion in gastropods</p>	14
V	<p><i>ECHINODERMATA AND HEMICHORDATA</i> Water-vascular system Echinoderm larvae <i>Balanoglossus</i>- Structure and affinities</p>	6

TEXTBOOKS

1. R.L. Kotpal, *Modern Text Book of Zoology - Invertebrates*.
2. P.S. Dhama and J.K. Dhama *Invertebrate Zoology*.

SUGGESTED READINGS

1. L.H. Hyman, '*The Invertebrates*' Vol I, II and V. – M.C. Graw Hill Company Ltd.
2. Ruppert, Fox and Barnes, *Invertebrate Zoology - A Functional Evolutionary Approach* - Thomas Publishers. Indian Edition.
3. E.L. Jordan and P.S. Verma '*Invertebrate Zoology*' S. Chand and Company.
4. R.D. Barnes '*Invertebrate Zoology*' by: W.B. Saunders CO., 1986.
5. Barrington. E.J.W. '*Invertebrate Structure and Function*' by ELBS.
6. Sedgwick. A. '*A Student Text Book of Zoology*' Vol-I, II and III – Central Book Depot, Allahabad.
7. Parker.T.J. & Haswell '*A Text Book of Zoology*' by, W.A., Mac Millan Co. London.

CO-CURRICULAR ACTIVITIES

- Preparation of chart/model of *Elphidium* life cycle
- Visit to Zoology museum or Coral island as part of Zoological tour
- Charts on life cycle of *Obelia*, polymorphism, sponge spicules
- Clay models of canal system in sponges
- Preparation of charts on life cycles of *Fasciola* and *Ascaris*
- Visit to adopted village and conducting awareness campaign on diseases, to people as part of Social Responsibility.
- Plaster-of-Paris or Thermocol model of *Peripatus*
- Construction of a vermicompost in each college, manufacture of manure by students and donating to local farmers
- Models of compound eye, bee hive and termitarium (termitaria) by students
- Visit to apiculture centre and short-term training as part of apprenticeship programme of the govt. of Andhra Pradesh
- Chart on pearl forming layers using clay or Thermocol
- Visit to a pearl culture rearing industry/institute
- Live model of water vascular system
- Phylogeny chart on echinoderm larvae and their evolutionary significance
- Preparation of charts depicting the feeding mechanism, 3 coeloms, tornaria larva etc., of *Balanoglossus*

I SEMESTER END EXAMINATIONS

PAPER – I MODEL PAPER Cours Code: ZOOT11A

Title of the paper: Animal Diversity Biology of Non – Chordates
(W.E.F 2022-2023)

Time: 3 Hours

Max. Marks: 70

Answer ALL the following questions 5X14=70m

1. a) Explain the different types of nutrition in protozoans. 10M CO5, L2
b) Describe the structure of Polystomella 4M CO 1, L1
OR
c) Explain the different types of canal system in sponges 10M CO5, L2
d) List out the different types of cells in sponges 4M CO1, L1
2. a) Evaluate the process of metagenesis in the life cycle of *Obelia*. 10M CO1, L5
(b) Describe *Obelia* medusa 4M CO1, L1
OR
c) Evaluate how ctenophores differ structurally from cnidarians. 10M CO1, L5
d) Describe Corals and coral reefs 4M CO1, L1
3. (a) Describe the life cycle of *Ascaris lumbricoides*. 10M CO2, L2
(b) Explain the significance of coelom in annelids 4M CO2, L2
OR
c) Describe the reproductive system of *Hirudinaria*. 10M CO2, L2
d) Explain the Flame cells in *Fasciola hepatica* 4M CO3, L2
4. a) Enumerate the economic importance of insects 10M CO3, L1
b) Explain the process of pearl formation and its significance 4M CO5, L2
OR
c). Describe torsion in gastropods as significant in larval development 10M CO3, L1
d). Structural affinities of Onychophora 4M CO4, L4
5. a) Analyze the functional suitability of water vascular system in echinoderms 10M CO5, L4
b) Explain bipinnaria larva in relation to phylogeny 4M CO3, L2
OR
c). Examine the structural affinities of *Balanoglossus*. 10M CO4, L4
d). *Peripatus* is a connecting link. Analyze 4M CO4, L4

PRACTICAL- I (At the end of I Semester)

Title of the paper: Animal Diversity Biology of Non – Chordates

No of Hours: 30

Credits: 02

WEF: 2021-2022 Course Code: ZOO P11A

LEARNING OUTCOMES:

By the end of the course students will be able to

1. Understand the general characters and classification from Protozoa to Hemichordata
2. Understand the importance of preservation of museum specimens
3. Identify animals based on special identifying characters
4. Understand different organ systems through demo or virtual dissections
5. Maintain a neat, labeled record of identified museum specimens
6. Exhibit the hidden creative talent

COURSE OUTCOMES

CO1 To identify the characteristics and systematic position of protozoans and poriferans PO1, PO2, PO5, PO6, PO7, PSO1

CO2 To identify the characteristics and systematic position of Cnidarians and Helmenthes. PO1, PO2, PO5, PO6, PO7, PSO1

CO3 To identify the characteristics and systematic position of Annelids, Arthropodans and Molluscans. PO1, PO2, PO5, PO6, PO7, PSO1

CO4 To identify the characteristics and systematic position of Echinoderms and hemichordates. PO1, PO2, PO5, PO6, PO7, PSO1

CO5 To understand the various systems of Prawn by Dissecting and Mounting its appendages. PO1, PO2, PO5, PO6, PO7, PSO1

Syllabus
Course Details

Unit	Learning Units
Syllabus	General characters and classification of the following phyla and sub-phyla up to classes with suitable examples: Protozoa, Porifera, Cnidaria, Platyhelminthes, Nematoda, Annelida, Arthropoda, Mollusca, Echinodermata and Hemichordata.
I	<p>SPOTTERS</p> <p>Porifera: <i>Euspongia</i>, <i>Spongilla</i>, <i>Sycon</i>. Cnidaria: <i>Physalia</i>, <i>Velella</i>, <i>Aurelia</i>, <i>Gorgonia</i>, <i>Pennatula</i>. Annelida: <i>Nereis</i>, <i>Heteronereis</i>, <i>Aphrodite</i>, <i>Hirudineria</i>. Arthropoda: <i>Scylla</i>, <i>Macrobrachium</i>, <i>Scolopendra</i>, <i>Sacculina</i>, <i>Limulus</i>, <i>Scorpion</i>, <i>Peripatus</i>. Mollusca: <i>Chiton</i>, <i>Murex</i>, <i>Unio</i>, <i>Sepia</i>, <i>Loligo</i>, <i>Octopus</i>, <i>Nautilus</i>. Echinodermata: <i>Asterias</i>, <i>Ophiothrix</i>, <i>Echinus</i>, <i>Clypeaster</i>, <i>Cucumaria</i>, <i>Antedon</i>. Hemichordata: <i>Balanoglossus</i></p>
II	<p>SLIDES</p> <p>Protozoa: <i>Elphidium</i>, <i>Paramoecium</i>, <i>Paramoecium</i> - Binary fission and conjugation, <i>Vorticella</i>, <i>Entamoebahistoltytica</i>, <i>Plasmodium vivax</i> Porifera: T.S and L.S. of <i>Sycon</i>, spicules, gemmule Cnidaria: <i>Obeliacolony</i> and medusa, Platyhelminthes: <i>Planaria</i>, <i>Fasciola hepatica</i>, <i>Fasciolalarval</i> forms (Miracidium, Redia, Cercaria) <i>Echinococcusgranulosus</i>, <i>Taeniasolium</i> Nematoda: <i>Ascarislumbricoides</i> (male and female), <i>Ancylostomaduodenale</i> (male and female), <i>Dracunculus</i>, <i>Wuchereria</i> Annelida: Trochophore larva Arthropoda: Mouthparts of housefly, butter fly, male and female <i>Anopheles</i> and <i>Culex</i>, Crustacean larvae (nauplius, mysis, zoea) Mollusca: Glochidium larva Echinodermata: Bipinnarialarva Hemichordata: Tornaria larva</p>
III	<p><u>DEMONSTRATION OF DISSECTIONS</u></p> <p>1. Prawn: Nervous system Mounting of statocyst Mounting of appendages 2. Mounting of Insect mouth parts</p> <ul style="list-style-type: none"> • Animal Album to be submitted at the time of practical examination • Laboratory Record Book to be submitted at the time of practical examination

Suggested Manuals

1. Practical Zoology- Invertebrates S.S.Lal
2. Practical Zoology - Invertebrates P.S.Verma
3. Practical Zoology K.P.Kurl

I B.Sc. ZOOLOGY PRACTICAL EXAMINATION

Practical - I

Course Code: ZOO P11A

Title of the paper: Animal Diversity Biology of Non – Chordates

Time: 3hrs.

Max. Marks 40M

1. List out the general characters of Phylum ----- . CO1 L1 3 M
2. Identify and draw a neat labeled diagram of nervous system/appendages of prawn. 7M
CO 4 L3 Identification: 1 M
Diagram: 4 M
Labeling: 2 M
2. Prepare a neat mount of statocyst/ mouth parts of cockroach. 5 M
CO4 L3 Mounting: 2 M
Diagram: 1 M
Labeling: 2 M
3. Identify, draw a labeled diagram, classify and write notes on A, B, C, D and E
CO3 L2 5 X 3 = 15 M
A. Protozoa & Porifera
B. Cnidaria & Platyhelminthes
C. Nematoda & Annelida
D. Arthropoda
E. Mollusca, Echinodermata & Hemichordata

Identification: 1 M
Diagram: ½ M
Classification: ½ M
Comments: 1 M
4. Practical Record Book CO5 L3 5 M
5. VIVA CO6 L5 5M

Total Marks :- 40M

ADUSUMILLI GOPALAKRISHNAIAH & SUGAR CANE GROWERS SIDDHARTHA DEGREE COLLEGE OF ARTS & SCIENCE, VUYYURU-521165, KRISHNA Dt., A.P. (AUTONOMOUS).

NAAC recredited at 'A' level
Autonomous –ISO 9001-2015 Certified

Title of the Paper: **Cell Biology, Cellular Metabolism, Genetics, Organic Evolution and Animal Behaviour**
Semester: - III

Course Code	ZOOT31A	Course Delivery Method	Class Room/Blended Mode - Both
Credits	3	CIA Marks	25
No. of Lecture Hours/ Week	4	Semester End Exam Marks	75
Total Number of Lecture Hours	60	Total Marks	100
Year of Introduction : 2017-18	Year of Offering 2021-2022	Year of Revision – 2021-22	Percentage of Revision: 100%

COURSE OUTCOMES:

CO1	To understand the basic unit of the living organisms and to differentiate the organisms by their cell structure. Describe fine structure and function of plasma membrane and different cell organelles of eukaryotic cell.
CO2	To understand the history of origin of branch of genetics, gain knowledge on heredity, interaction of genes, various types of inheritance patterns existing in animals
CO3	Acquiring in-depth knowledge on various aspects of genetics involved in sex determination, human karyotyping and mutations of chromosomes resulting in various disorders
CO4	Understand the central dogma of molecular biology and flow of genetic information from DNA to proteins.
CO5	Understand the principles and forces of evolution of life on earth, the process of evolution of new species and apply the same to develop new and advanced varieties of animals for the benefit of the society

Syllabus
Course Details

Unit	Learning Units	Lecture Hours
I	<p>Cell Biology : Electron microscopic structure of animal cell. Structure and functions of Golgi complex, Endoplasmic Reticulum And Liposome's Structure and functions of Ribosome's and Mitochondria Structure and functions of Chromosomes (Polygene and Lamp brush chromosomes) Structure and functions of Nucleus and its components</p>	14
II	<p>CELLULAR METABOLISM Bio molecules Carbohydrates - Classification of carbohydrates; Structure of glucose Proteins - Classification of proteins; General properties of amino acids Lipids - Classification of lipids 1 Hour Carbohydrate metabolism – Glycogen metabolism, Gluconeogenesis Protein metabolism-Transamination, Deamination and Urea Cycle</p>	11
III	<p>GENETICS Gene interactions (lethal genes, Epistasis & Pleiotropy) DNA damage and repair Human karyotyping and amniocentesis Autosomal and allosomal disorders (Klinefelter syndrome, Turner Syndrome, Down syndrome, Phenylketonuria, Alkaptonuria & Sickle cell anaemia)</p>	11
IV	<p>ORGANIC EVOLUTION Modern synthetic theory of evolution Variations Isolating mechanisms Types of natural selection (directional, stabilizing & disruptive) Artificial selection Speciation – allopatry and sympatry. Microevolution vs. Macroevolution (Example: Darwin finches)</p>	10
V	<p>ANIMAL BEHAVIOUR Ethology and its branches. Concepts of Ethology (motivation, fixed action patterns, releasers, learning) Biological clocks Biological rhythms (Circadian, Circalunar and Circannual) Sexual behavior in animals (Intra sexual selection & Inter sexual selection) Coloration & Mimicry</p>	14

**A.G. &S.G.Siddhartha Degree College of Arts & Science, Vuyyuru – 521165,
Krishna Dt. A.P. (Autonomous)**

Semester III *w.e.f. 2022-2023*

(Model question paper)

Title of the paper: Cell Biology, Cellular Metabolism, Genetics, Organic Evolution and Animal Behaviour

Code – ZOOT31A

Time: 3hrs.

max.marks: 75

Section – A

4 x 5= 20.

Answer any **four** questions. Each question carries **five** marks. Draw neat labeled diagrams wherever necessary.

Draw neat labeled diagrams wherever necessary.

SECTION –A

Answer and **FIVE** of the following

5x5=25 Marks

1. General properties of amino acids **CO2, L2**
2. Explain Urea Cycle **CO2, L2**
3. Klinefelter syndrome **CO3, L2**
4. Epistasis **CO3, L2**
5. Industrial melanism **CO4, L2**
6. Allopatry and sympatry **CO4, L1**
7. Classical conditioning **CO5, L2**
8. Circadian rhythms **CO5, L2**

SECTION – B

Answer any **FIVE** of the following

5X10=50 Marks

9. Write electron microscopic structure of animal cell **CO1, L6**
OR
Explain the structure and functions of polytene and lamp brush chromosomes. **CO1, L2**
 10. What are Carbohydrates? Write the classification of Carbohydrates. **CO2, L6**
OR
Write an essay on Protein Metabolism. **CO2, L6**
 11. Give an account on Gene Interactions. **CO3, L2**
OR
Narrate an essay on autosomal and allosomal disorders. **CO3, L2**
 12. Write an essay on Isolating mechanisms. **CO4, L6**
OR
Explain modern synthetic theory of evolution. **CO4, L2**
 13. Elucidate the biological rhythms in animals. **CO5, L1**
OR
Give an account of the types of mimicry in animals. **CO5, L6**
-

.Title:-Cell Biology, Cellular Metabolism, Genetics, Organic Evolution and Animal Behaviour.

Code: ZOOP31A

Credits:- (02)

MAX.MARKS: 40 2hrs/week)

SYLLABUS

Learning Objectives:

- Acquainting and skill enhancement in the usage of laboratory microscope
- Hands-on experience of different phases of cell division by experimentation
- Develop skills on human karyotyping and identification of chromosomal disorders
- To apply the basic concept of inheritance for applied research
- To get familiar with phylogeny and geological history of origin & evolution of animals.

I. CellBiology

1. Preparation of temporary slides of Mitotic divisions with onion root tips
2. Observation of various stages of Mitosis and Meiosis using permanent slides
3. Mounting of salivary gland chromosomes of *Chironomus*

II. Cellular Metabolism

1. Estimation of total proteins in given solutions by Biurette method.
2. Estimation of total carbohydrate by Trinder's method.

III. Genetics

A, B, O blood typing. Problems based on Blood grouping.

Karyotyping of human chromosomes [Human karyotype figure on paper should be cut in to different sets of chromosomes and students are asked to arrange them in an order and comment on the ideogram]

Identification of genetic syndromes given on charts.

Pedigree Analysis

IV. Evolution

1. Study of fossil evidences
2. Study of homology and analogy from suitable specimens and pictures
3. Phylogeny of horse with pictures
4. Darwin finches (pictures)

A. G & S. G. S. DEGREE COLLEGE OF ARTS & SCIENCE, VUYYURU 521165, KRISHNA Dt., A.P. (AUTONOMOUS)

PAPER – III

Title: Cell Biology, Cellular Metabolism, Genetics, Organic Evolution and Animal Behaviour

w.e.f.2022-23.

Time:3hrs Model Question paper (External)Max.Marks: 40 M.

Paper Code: ZOOP31A

1. Describe ABO blood typing. Identify the given sample. **CO3,L27M**

Procedure 04

Slide Preparation 02

Result 01

2. In Holstein cattle the spotting of the coat is due to a recessive gene while a solid-coloured coat is dominant. What types of offspring might be produced by a cross between two spotted animals? Show how you reach your conclusion. The gene P is responsible for coat pattern. **CO3,L45M**

3. Identify, draw a labelled diagram and write a comment upon A, B, C, D and E. **5 X 3=15M**

CO1, CO2, CO3, CO4, CO5, L1

A. Down syndrome

B. Parental care in *Hippocampus*

C. Protective colouration in *Octopus*

D. Bee hive

E. *Cedaroid*

Identification 1

Diagram 1

Characters 1

4. Field Note book **03M**

5. Viva **05M**

6. RECORD **05M**

.....

**ADUSUMILLI GOPALAKRISHNAIAH & SUGAR CANE GROWERS SIDDHARTHA DEGREE
COLLEGE OF ARTS & SCIENCE, VUYYURU-521165, KRISHNA Dt., A.P. (AUTONOMOUS).**

NAAC reaccredited at 'A' level
Autonomous –ISO 9001-2015 Certified

Title of the Paper: **SUSTAINABLE AQUACULTURE MANAGEMENT**

Semester: - V

Course Code	SEC 6A501/601	Course Delivery Method	Class Room/Blended Mode - Both
Credits	3	CIA Marks	30
No. of Lecture Hours/ Week	3	Semester End Exam Marks	70
Total Number of Lecture Hours	60	Total Marks	100
Year of Introduction: 2022-23	Year of Offering 2022-2023	Year of Revision	Percentage of Revision: 100%

Learning Outcomes: -Students at the successful completion of this course will be able to

CO1: Evaluate the present status of aquaculture at the Global level and National level

CO2: Classify different types of ponds used in aquaculture

CO3: Demonstrate induced breeding of carps

CO4: Acquire critical knowledge on commercial importance of shrimps

CO5: Identify fin and shell fish diseases

||

Syllabus

Course Details

Unit	Learning Units	Lecture Hours
I	Present status of Aquaculture – Global and National scenario, Major cultivable species for aquaculture: freshwater, brackish water and marine. Traditional, extensive, modified extensive, semi-intensive and intensive cultures of fish and shrimp. Design and construction of fish and shrimp farms.	15
II	Functional classification of ponds – head pond, hatchery, nursery ponds. Functional classification of ponds -rearing, production, stocking and quarantine ponds. Need of fertilizer and manure application in culture ponds. Physio-chemical conditions of soil and water optimum for culture (Temperature, depth, turbidity, light, water, PH, BOD, CO ₂ and nutrients)	15
III	Induced breeding in fishes Culture of Indian major carps: Pre-stocking management (Dewatering, drying, ploughing/desilting; Predators, weeds and algal blooms and their control, Liming and fertilization) Culture of Indian major carps - Stocking management Culture of Indian major carps - post-stocking management	10
IV	Commercial importance of shrimp & prawn <i>Macrobrachium rosenbergii</i> - biology, seed production. Culture of <i>L. vannamei</i> – hatchery technology and culture practices Mixed culture of fish and prawns.	10
V	Viral diseases of Fin Fish & shellfish Fungal diseases of Fin & Shellfish Bacterial diseases of Finfish & Shellfish Prophylaxis in aquaculture	10

**A.G& S.G.S.DEGREECOLLEGE OF ARTS & SCIENCE, VUYURU – 521165,
KRISHNA Dt.,A.P. (AUTONOMOUS)
SEMESTER-V (Model Question paper)**

Paper Title: SUSTAINABLE AQUACULTURE MANAGEMENT

w.e.f.- 2022-2023

Paper Code: SEC6A501/601

Time: 3 hrs.Max.Marks:70

Part – A

Answer **any FOUR** questions out of eight in Part - A. Each question carries five marks.
4X5=20

Part – A

- 1 .Traditional culture
- 2Semi-intensive
- 3.Head pond
- 4.stockingponds.
- 5.Predators
- 6.Liming
- 7.*Macrobrachiumrosenbergii*
8. Bacterial diseases of Finfish

Part – B

Answer **any FIVE** questions out of eight in Part - B .Each question carries Ten marks.
5X10=50

9. Write an essay on Cultivable species for aquaculture from fresh water brackish water Marinewater.?
10. Write an essay on Design and construction of fish form?
11. Explain about Rearing pond?.
12. Write about water quality and soil characteristics suitable for fish culture?.
13. Give an account of Induced breeding infishes?
14. Write in detail about the post-stockingmanagement.
15. Write an essay on.Seedproduction?
16. Discuss about the Bacterial diseases of Finfish and shell fish?

A.G& S.G.S.DEGREE COLLEGE OF ARTS & SCIENCE, VUYURU 521165, KRISHNA Dt., A.P.
(AUTONOMOUS)

SEMESTER-V

Time: 3 hrs

Guide lines to the paper setter

Paper Title: **SUSTAINABLE AQUACULTURE MANAGEMENT**

Paper Code: ZOO -501C

Max.Marks:70m.

Note:1. Answer any FOUR questions out of eight in Part-A . Each question carries five marks.4X 5 = 20M.

2. Answer any FIVE questions out of eight in Part-B . Each question carries 10 marks. 5 X 10 = 50M.

	PART	Unit – I	Unit – II	Unit – III	Unit – IV	Unit – V
5 Marks Questions	A	2	2	2	1	1
10 Marks Questions	B	2	2	2	1	1
Weightage		30	30	30	15	15

Note: 1. please provide the scheme of valuation for the paper.

2. Question paper should be both in English and Telugu media.

I. References:

1. Pillay TVR &M.A.Dill, 1979. Advances in Aquaculture. Fishing News Books Ltd.,London
2. Stickney RR 1979. Principles of Warm Water Aquaculture. John Wiley & SonsInc.1981
3. Boyd CE 1982. Water Quality Management for Pond Fish Culture. Elsvier Scientific PublishingCompany.
4. Bose AN et.al. 1991. Costal Aquaculture Engineering. Oxford &IBH Publishing Company Pvt.Ltd.

Web Links:

1. http://www.fao.org/fishery/docs/CDrom/FAO_Training/FAO_Training/General/x6708e/x6708e06.htm
2. http://aquaticcommons.org/1666/1/Better-Practice3_opt.pdf
3. <https://www.notesonzoology.com/india/fishery/fish-diseases-symptoms-and-control-fishery/871>

PRACTICAL - V

w.e.f. 2022-2023.Code: ZOO- 501PMAX.MARKS: 50M

(2hrs/week)Credits: 02

(30 hrs) **Sustainable Aquaculture Management**

PRACTICAL SYLLABUS

Learning Outcomes: On successful completion of this practical course, student shall be able to:

- ❖ · Identify the characters of Fresh water cultivable species
- ❖ · Estimate physico chemical characteristics of water used for aquaculture
- ❖ · Examine the diseases of fin and shell fish
- ❖ · Suggest measures to prevent diseases in aquaculture

Practical (Laboratory) Syllabus:

1. Fresh water Cultivable species any (Fin & Shell Fish Specimens – Observation of morphological characters by observation and drawings)-5
2. Brackish water cultivable species (Fin & Shell fish- Specimens- Observation of Morphological Character by observing drawing) -5
3. Hands on training on the use of kits for determination of water quality in aquaculture (DO, Salinity, pH, Turbidity- Testing kits to be used for the estimation of various parameters/ Standard procedure can be demonstrated for the same)
4. Demonstration of Hypophysation (Procedure of hypophysation to be demonstrated in the Practicallab with any edible fish as model)
5. Viral diseases of Fin & Shell Fish (Observation of his to pathological slides / Charts/ Models of viral pathogens in fin/ shell fish – one edible specimen can be used for observation of same in the laboratory)
6. Bacterial diseases of Fin & Shell Fish (Observation of his to pathological slides / Charts/ Models of Bacterial pathogens in fin/ shell fish – One edible specimen can be used for observation of same in the laboratory)
7. Fungal diseases of Fin & Shell Fish (Observation of his to pathological slides / Charts/ Models of Bacterial pathogens in fin/ shell fish – One edible specimen can be used for observation of same in the laboratory)

VI. Lab References

1. Boyd CE 1982. Water Quality Management for Pond Fish Culture. Elsevier Scientific Publishing Company
2. http://www.fao.org/fishery/docs/CDrom/FAO_Training/FAO_Training/General/x6708e/x6708e06.htm
3. http://aquaticcommons.org/1666/1/Better-Practice3_opt.pdf
4. https://www.notesonzooology.com/india/fishery/fish-diseases-symptoms-and-control_fishery/871

Web resources suggested by the teacher concerned and the college librarian including reading material

VII. Co-Curricular Activities

a) **Mandatory:** *(Student training by teacher in field skills: Total 15 hrs., Lab:10 + field 05)*

1. For Teacher: Training of students by the teacher in laboratory/field for not less than 15 hours on Breeding- Induced breeding in carps -hatchery technology of *L. Vennami*- Farming techniques- disease diagnostic techniques—concepts –Demonstration @ any aqua laboratory .
2. For Student: Students shall (individually) visit a Hatchery/Farm/ Aqua diagnostic center and make careful observations of the process method and implements- protocols and report on the same in 10 pages hand written Fieldwork/Project work Report.
3. Max marks for Fieldwork/Project work Report: 05
4. Suggested Format for Fieldwork/Project work: Title page, student details, index page, details of place visited, observations made, findings and acknowledgements
5. (IE). Unit tests.

b) Suggested Co-Curricular Activities

1. Preparation of Model/Charts of Cultivable species of fin fish shell fish
2. Preparation of Model/Chart of Ideal fish Pond- with the standards prescribed.
3. Observation of aquaculture activities in their area (Observation of any activity related to aquaculture in the vicinity of the college/village)
4. Preparation of Model – charts of Fin /Shell fish Diseases with eco-friendly material.
5. Assignments, Group discussion, Seminar, Quiz, Collection of Material, Video preparation etc., Invited lecture

**A. G & S. G. S. DEGREE COLLEGE OF ARTS & SCIENCE, VUYYURU 521165, KRISHNA Dt.,
A.P. (AUTONOMOUS)
PAPER – III**

Guide lines for the practical Examiner

W.e.f.2022-2023

Class: III B.Z.C

Paper Title: Paper: Sustainable Aquaculture Management Code: ZOO-501P

Credits:(02)Max.Marks: 25 M.

-
1. Spotters: Identify, draw neat labeled diagram and comment on 5X2=10 m
A, B, C,D & E
 2. Estimation of Dissolved Oxygen in given water sample 5m
 - 3.. Procedure of hypophysation 4 m
 4. Commenton identification and study of Bacterial, viral and fungal diseases in edible fishes 3X2=6m
A,B & C

Total -- 25M

**A. G.&S.G. SIDDHARTHA DEGREE COLLEGE OF ARTS & SCIENCE, VUYYURU-521165
ZOOLOGY PRACTICAL -V**

**(INTERNAL)
w.e.f. 2022-2023.**

(2hrs/week).

Sustainable Aquaculture Management

Code: ZOO-501P.

Max.marks:25M.

Time: 3hrs.

1. Attendance ----- 5M.
2. Record ----- 10M.
3. Assignments -----10M.

Total ----- 25M.

**ADUSUMILLI GOPALAKRISHNAIAH & SUGAR CANE GROWERS SIDDHARTHA DEGREE
COLLEGE OF ARTS & SCIENCE, VUYYURU-521165, KRISHNA Dt., A.P. (AUTONOMOUS).**

NAAC recredited at 'A' level
Autonomous –ISO 9001-2015 Certified

Title of the Paper: **POSTHARVEST TECHNOLOGY OF FISH AND FISHERIES**

Semester: - V

Course Code	SEC7A502/602	Course Delivery Method	Class Room/Blended Mode - Both
Credits	3	CIA Marks	30
No. of Lecture Hours/ Week	3	Semester End Exam Marks	70
Total Number of Lecture Hours	60	Total Marks	100
Year of Introduction : 2022-23	Year of Offering 2022-2023	Year of Revision	Percentage of Revision: 100%

Objective of the course To prepare students to become future aqua culturists.

CO 1	Identify the types of preservation methods employed in aquaculture
CO 2	Choose the suitable processing methods in aquaculture
CO 3	They can earn while they learn
CO 4	Maintain the standard quality control protocols laid down in aqua industry
CO 5	Identify the best Seafood quality assurance system

Syllabus**Course Details**

Unit	Learning Units	Lecture Hours
I	Handling and Principles of fish Preservation Handling of fresh fish, storage and transport of fresh fish, post mortem changes (rigor mortis and spoilage), spoilage in marine fish and freshwater fish. Principles of preservation – cleaning, lowering of temperature, rising of temperature, denudation, use of salt, use of fish preservatives, exposure to low radiation of gamma rays.	15
II	Methods of fish Preservation Traditional methods - sun drying, salt curing, pickling and smoking. .Advanced methods – chilling or icing, refrigerated sea water, freezing, canning, irradiation and Accelerated Freeze drying (AFD).	08
III	Processing and preservation of fish and fish by-products Fish products – fish minced meat, fish meal, fish oil, fish liquid (ensilage), fish protein concentrate, fish chowder, fish cake, fish sauce, fish salads, fish powder, pet food from trash fish, fish manure. Fish by-products – fish glue, Using glass, chitosan, pearl essence, shark fins, fish Leather and fish maws.	17
IV	Sanitation and Quality control Sanitation in processing plants - Environmental hygiene and Personal hygiene in processing plants. Quality Control of fish and fishery products – pre-processing control, control during processing and control after processing.	08
V	Quality Assurance, Management and Certification Seafood Quality Assurance and Systems: Good Manufacturing Practices (GMPs); Good Laboratory Practices (GLPs); Standard Operating Procedures (SOPs); Concept of Hazard Analysis and Critical Control Points (HACCP) in seafood safety. National and International standards – ISO 9000: 2000 Series of Quality Assurance System, <i>Codex Alimentarius</i> .	12

**A.G& S.G.S.DEGREECOLLEGE OF ARTS & SCIENCE, VUYURU – 521165,
KRISHNA Dt.,A.P. (AUTONOMOUS)
SEMESTER-V (Model Question paper)**

Paper Title: POSTHARVEST TECHNOLOGY OF FISH AND FISHERIES w.e.f.- 2022-2023

Paper Code: SEC7A502/602

Time: 3 hrs.Max.Marks:70 m.

Part – A

Answer **any FOUR** questions out of eight in Part - A. Each question carries five marks.
4X5=20

Part – A

- 1.Post mortem changes
- 2 Cleaning,
- 3.Sun drying,
- 4.Canning,
- 5.Chitosan
- 6.Pre-processing control,
- 7.Good Manufacturing Practices
8. *Codex Alimentarius*.

Part – B

Answer **any FIVE** questions out of eight in Part - B .Each question carries Ten marks.
5X10=50

09. Give a detailed account on handling of fresh fish and storage fish
10. Describe the processes principles of preservation
11. Explain Traditional methods of fish drying
12. Explain any four fish products?
13. Describe any four fish by products?
14. Give a detailed note on sanitation in processing plant.
15. Describe the process of quality control in processing plants
16. Write about National and International standards for quality control. ?

A.G& S.G.S.DEGREE COLLEGE OF ARTS & SCIENCE, VUYURU 521165, KRISHNA Dt., A.P.
(AUTONOMOUS)

SEMESTER-V

Time: 3 hrs

Guide lines to the paper setter

Paper Title: **POSTHARVEST TECHNOLOGY OF FISH AND FISHERIES**

Paper Code: ZOO -502

Max.Marks:70m

Note: 1. Answer **any FOUR** questions out of eight in Part-A . Each question carries five marks. 4X 5 = 20M.

2. Answer any **FIVE** questions out of eight in Part-B . Each question carries 10 marks. 5 X 10 = 50M.

	PART	Unit – I	Unit – II	Unit – III	Unit – IV	Unit – V
5 Marks Questions	A	2	2	1	1	2
10 Marks Questions	B	2	1	2	2	1
Weightage		30	20	25	25	20

Note: 1. please provide the scheme of valuation for the paper.

2. Question paper should be both in English and Telugu media.

III. References:

1. Santharam R, N Sukumaran and P Natarajan 1987. A manual of aquaculture, Oxford-IBH, NewDelhi
2. Lakshmi Prasad's, Fish Processing Technology 2012, Arjun Publishing House
3. Dr Sunitha Rai, Fish Processing Technology, 2015, Random Publications
4. Safety and Quality Issues in Fish Processing (Woodhead Publishing Series in Food Science, Technology and Nutrition) by H A Bremner
5. K.A Mahanthy, Innovations in Fishing and Fish Processing Technologies, January 2021

Web Resources:

1. <http://ecoursesonline.iasri.res.in/mod/page/view.php?id=145743>
2. https://ecourses.icar.gov.in/e-Learningdownload3_new.aspx?Degree_Id=03

Learning Outcomes:

On successful completion of this practical course, student shall be able to:

- Identify the quality of aqua processed products.
- Determine the quality of fishery by products by observation.
- Analyze the protocols of aqua processing methods.

Practical Syllabus:

1. Evaluation of fish/fishery products for organoleptic, chemical and microbial quality.
2. Preparation of dried, cured and fermented fish
3. Examination of salt, protein, moisture in dried/cured products
4. Examination of spoilage of dried/cured fish products marinades, pickles, sauce.
5. Preparation of fish gelatin, collagen and chitosan from shrimp and crab shell.
6. Developing flowcharts and exercises in identification of hazards – preparation of Hazard analysis worksheet
7. Corrective action procedures in processing of fish – flowchart – worksheet preparation.

References:

- Balachandran KK. 2001. *Post-harvest Technology of Fish and Fish Products*. Daya Publ.
2. Bond, et al. 1971. *Fish Inspection and Quality Control*. Fishing News Books, England.

Websites of Interest:

- https://www.youtube.com/watch?v=xyf_g7fku-4
https://www.youtube.com/watch?v=bvtqb_cmy4

Co-Curricular Activities

- a) Mandatory:** (*Lab/field training of students by teacher (lab 10 + field 05)*): 1. For Teacher: Training of students by the teacher in laboratory/field for not less than 15 hours on various steps of post-harvest techniques of fishes, on the advanced techniques in post-harvest technology – Training of students on other employability skills in the Post-harvest sector of Aquaculture Industry- like Processing, Packing, marketing of processed aqua products. 2. For Student: Students shall (individually) visit - Any fish/shrimp Processing Plant/Packing industry and make observations on post harvesting techniques and submit a brief handwritten Fieldwork/Project work Report with pictures and data /survey in 10 pages.
3. Max marks for Fieldwork/Project work Report: 05.
4. Suggested Format for Fieldwork/Project work: *Title page, student details, index page, details of place visited, observations made, findings and acknowledgements*
5. (IE): Unit tests,

b) Suggested Co-Curricular Activities

1. Observation of fish/shrimp processing plants – visit web sites of processing companies and record the details of that Unit
2. Interaction with local fishermen to know the method of preservation and details with the available traditional technology
3. Collection of web resources on the Quality assurance, quality control measures in Aqua Industries- cross checking the standards during the visit to any processing units. 4. Assignments, Seminar, Group discussion. Quiz, Collection of Material, Invited lecture, Video preparation etc.,

**A. G & S. G. S. DEGREE COLLEGE OF ARTS & SCIENCE, VUYYURU 521165, KRISHNA Dt.,
A.P. (AUTONOMOUS)
PAPER – III**

Guide lines for the practical Examiner

W.e.f.2022-2023

Class: III B.Z.C

Paper Title: Paper: POSTHARVEST TECHNOLOGY OF FISH AND FISHERIES Code: ZOO-502P

Credits:(02)Max.Marks: 25 M.

-
- | | |
|--|----|
| 1. Evaluation of fish/fishery products for organoleptic and microbial quality. | 6m |
| 2. Preparation of dried and fermented fish | 4m |
| 3 Examination of salt in dried fish products | 5m |
| 4 Examination of spoilage of cured fish pickles . | 5m |
| 5 Preparation of isinglass shrimp and crab shell. | 5m |

Total -- 25M

**A. G.& S.G. SIDDHARTHA DEGREE COLLEGE OF ARTS & SCIENCE, VUYYURU-521165
ZOOLOGY PRACTICAL -V**

**(INTERNAL)
w.e.f. 2022-2023.**

(2hrs/week).

Title:-**POSTHARVEST TECHNOLOGY OF FISH AND FISHERIES**

Code: ZOO-502P.

Max.marks:25M.

Time: 3hrs.

- | | |
|----------------|------------|
| 1. Attendance | ----- 5M. |
| 2. Record | ----- 10M. |
| 3. Assignments | -----10M. |

Total ----- 25M.

**ADUSUMILLI GOPALAKRISHNAIAH & SUGAR CANE GROWERS SIDDHARTHA DEGREE
COLLEGE OF ARTS & SCIENCE, VUYYURU-521165, KRISHNA Dt., A.P. (AUTONOMOUS).**

NAAC recredited at 'A' level
Autonomous –ISO 9001-2015 Certified

Title of the Paper: **Health and Hygiene**

Semester: - III

Course Code	LSCZOOT01	Course Delivery Method	Class Room/Blended Mode - Both
Credits	2	CIA Marks	00
No. of Lecture Hours/ Week	10	Semester End Exam Marks	50
Total Number of Lecture Hours		Total Marks	50
Year of Introduction :	Year of Offering 2022-2023	Year of Revision – 2021-23	Percentage of Revision: 0%

LIFE SKILL COURSE	Course code: LSCZOOT01	2022-2023	BA, B. Com (G), B.Com e-commerce, B.Com-Computers, A.B.C., & B.Z.C
--------------------------	---------------------------	------------------	---

Learning Outcomes:

- To provide knowledge on different health indicators and types of hygiene methods
- To impart knowledge on different health care programmes taken up by India
- To make student understand the latest concepts of health such as HIA, EIA, SIA and SEA
- To enable student with disaster mitigation strategies
- To create awareness on community health and hygiene
- To enrich knowledge on communicable and non-communicable diseases and their control
- To aware the student on the importance of food, social strategies, mental status and physical activities on health
- To introduce different community-based mobile apps on health to student and thereby to the community

Course Outcomes: On completion of this course, the students will be able to understand -

- What is a healthy diet
- How can we use available information to optimize our diet?
- Can nutrition be used for a healthy life?
- Is there a one-size-fits-all “good” diet or should we individualize our dietary goals?
- Disaster management and responsiveness of public in pandemic and epidemic diseases
- Assess the impact of policies on health and hygiene Health measures to consider
- While travelling
- Awareness in public through digital media viz., mobile apps

Syllabus

Course Details

Unit	Learning Units	Lecture Hour
I	<p><u>Basics of Nutrition</u> Nutrition – definition, importance, Good nutrition and mal nutrition; Balanced Diet: Basics of Meal Planning Carbohydrates – functions, dietary sources, effects of deficiency. Lipids – functions, dietary sources, effects of deficiency. Proteins – functions, dietary sources, effects of deficiency. Brief account of Vitamins- functions, food sources, effects of deficiency, Macro and micro minerals – functions, effects of deficiency; food sources of Calcium, Potassium and Sodium; food sources of Iron, Iodine and Zinc Importance of water– functions, sources, requirement and effects of deficiency.</p>	10
II	<p><u>Health</u> Health - Determinants of health, Key Health Indicators, Environment health & Public health; Health-Education: Principles and Strategies Health Policy & Health Organizations: Health Indicators and National Health Policy of Govt. of India-2017; Functioning of various nutrition and health organizations in India viz., NIN (National Institution of Nutrition), FNB (Food and Nutrition Board), ICMR (Indian Council of Medical Research), IDA (Indian Dietetics Association), WHO-India, UNICEF-India National Health Mission: National Rural Health Mission (NRHM) Framework, National Urban Health Mission (NUHM) Framework Women & Child Health Care Schemes: Reproductive, Maternal, Newborn, Child and Adolescent Health (RMNCH+); Janani Shishu Suraksha Karyakaram (JSSK); Rashtriya Bal Swasthya Karyakram (RBSK); India Newborn Action Plan (INAP); Adolescent Health- Rashtriya Kishor Swasthya Karyakram (RKSK) Disaster Management – Containment, Control and Prevention of Epidemics and Pandemics – Acts, Guidelines and Role of Government and Public.</p>	10
III	<p><u>Hygiene</u> Hygiene – Definition; Personal, Community, Medical and Culinary hygiene; WASH (Water, Sanitation and Hygiene) programme Rural Community Health: Village health sanitation & Nutritional committee (Roles & Responsibilities); About Accredited Social Health Activist (ASHA); Village Health Nutrition Day, Rogi Kalyan Samitis Community & Personal Hygiene: Environmental Sanitation and Sanitation in Public places Public Awareness through Digital Media - An Introduction to Mobile Apps of Government of India: NHP, Swasth Bharat, No More Tension, Pradhan Mantri Surakshit Mantritva Abhiyan (PM Suman Yojana), My Hospital (Meraaspaal), India fights Dengue, JSK Helpline, Ayushman Bhava, Arogya Setu, Covid19AP</p>	10

A.G. &S.G.Siddhartha Degree College of Arts & Science, Vuyyuru – 521165, Krishna Dt. A.P.
(Autonomous)

Semester –III

w.e.f. 2022-2023Time: 90 mins

(Model question paper)

Title of the paper:Health and HygieneCode – LSCZOOT01

max.marks: 40

Section – A

Answer any **four** questions. Each question carries **five** marks. $2 \times 5 = 10$.

1. Balanced Diet
2. Vitamins
3. ICMR
4. Village Health Nutrition Day

Section – B

Answer any **three** questions. Each question carries **Ten** marks. $3 \times 10 = 30$

5. Define Nutrition and write it's importance?
6. What are Carbohydrates, write itsfunctions, dietary sources, effects ofdeficiency.
7. Define Health Explainthe Determinants of health. ?
8. Write an essay on National Institution of Nutrition (NIN)?
9. Write an essay onCommunity & Personal Hygiene?
10. Give an accountPradhanMantri SurakshitMantritva Abhiyan (PM Suman Yojana)?

SEMESTER-III
SKILL DEVELOPMENT COURSE

Guide lines to the paper setter
Max.Marks:40

Time: 1½ hrs

Paper Title: Health and Hygiene Code – LSCZOOT01-

*Note:*1. Answer **any four** questions out of eight in Part-A. Each question carries five marks.2X 5 = 10M.

2. Answer any**three** questions out of five in Part-B. Each question carries 10 marks.3 X 10 = 30M.

	PART	Unit –I	Unit – II	Unit-III
5 Marks Questions	A	2	1	1
10 Marks Questions	B	2	2	2
Weightage		30	35	25

- Note:**
1. please provide the scheme of valuation for the paper.
 2. Question paper should be both in English and Telugu media.

**AG & SG SIDDHARTHA DEGREE COLLEGE OF ARTS & SCIENCE
(AUTONOMOUS) VUYYURU- 521165**

Re-Accredited by NAAC with 'A' Grade

2022-2023





PG Department of Chemistry

Minutes of the meeting of Board of Studies

15-11-2022

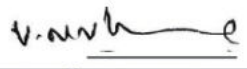
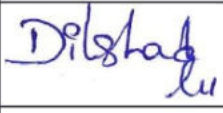
Members Present:-

S.No	NAME		Signature
1	Dr. V.Sreeram Head, Dept. of Chemistry(P.G) AG & SG S College, Vuyyuru.	Chairman	
2	Prof.C.Suresh Reddy Department of Chemistry S.V. University, Tirupati.	University Nominee	
3	Prof. Koya Prabakar Rao Department of Chemistry Vignana University, Guntur.	Subject Expert	
4	Dr.M.Sivanath Associate prof. Dept. of Chemistry A.N.R.College, Gudivada.	Subject Expert	
5	Dr.G.Raja Manager(Q.A) Biophore India pharmaceuticals. Hyderabad.	Representative from Industry	
6	Abdul Raheem	One Post Graduate Meritorious Alumnus nominated by the Principal	
7	N.V.Srinivasa Rao Department of Mathematics AG & SG S College, Vuyyuru.	Representative Science Faculty Other Dept.	
8	V.N.V.Kishore Dept. of Chemistry(P.G) AG & SG S College, Vuyyuru	Member	
9	Dilshad Begum Dept. of Chemistry(P.G) AG & SG S College, Vuyyuru	Member	
10	M.Rekha Dept. of Chemistry(P.G) AG & SG S College, Vuyyuru	Member	

A.G. & S.G. Siddhartha Degree College of Arts & Science, Vuyyuru – 521165.
(An Autonomous College in the jurisdiction of Krishna University)

DEPARTMENT OF CHEMISTRY(P.G)

Board of Studies for the academic Year 2022-23 (Odd Semesters)

1. Agenda

Proposed agenda for Board of studies in **Chemistry** on 15/11/2022 through online mode at 04:00P.M.

1. Approval of programme structure for the batch of students admitted in the year 2022-2023 onwards and if required necessary modifications can be made in the course titles of III & IV semester in later course.
2. Approval of syllabus for I semester for the batch of students admitted in the year 2022 – 2023 as per revised guidelines / curriculum of Krishna University and with no revision of syllabus of III semester for the batch of students admitted in the year 2021-2022.
3. Approval of the syllabus of semester – I & III with course out comes drafted inline with levels of blooms taxonomy.
4. Approval of modified model question papers for I semester & unmodified model question papers for III semester inline with Bloom's taxonomy.
5. Any other with the permission of the chairman.

**A.G. & S.G. SIDDHARTHA DEGREE COLLEGE OF ARTS & SCIENCE
DEPARTMENT OF CHEMISTRY**

**PROPOSED COURSE STRUCTURE FOR PG PROGRAMS (SCIENCE STREAM)
UNDER CHOICE BASED CREDIT SYSTEM (CBCS)
W.E.F 2022-23 (R22 Regulations)**

I SEMESTER

Course Code	Course Name	Teaching Hours/ week			CORE / IDC/DSE/ SEC/OEC/ MOOCS	Internal Marks	External Marks	No. of Credits
		Lecture	Practical	Tutorial				
22CH1T1	General Chemistry	4	0	0	Core	30	70	4
22CH1T2	Inorganic Chemistry	4	0	0	Core	30	70	4
22CH1T3	Organic Chemistry	4	0	0	Core	30	70	4
22CH1T4	Physical Chemistry	4	0	0	Core	30	70	4
COMPULSORY 22PG101	Personality Development through Life Enlightenment Skills	3	1	0	Core	30	70	3
22CH1L1	Inorganic chemistry Practical	0	6	0	Core	30	70	3
22CH1L2	Organic chemistry Practical -I	0	6	0	Core	30	70	3
TOTAL FOR FIRST SEMESTER						210	490	25

II SEMESTER

Course Code	Course Name	Teaching Hours/ week			CORE / IDC/DSE / SEC/OEC/MOOC S	Internal Marks	External Marks	No. of Credits
		Lecture	Practical	Tutorial				
22CH2T1	Advanced Inorganic Chemistry	4	0	0	Core	30	70	4
22CH2T2	Advanced Organic chemistry	4	0	0	Core	30	70	4
22CH2T3	Advanced Physical Chemistry	4	0	0	Core	30	70	4
COMPULSORY 22PG201	Research Methodology & IPR	3	1	0	SEC	30	70	3
DOMAIN SPECIFIC ELECTIVE COURSES (CHOOSE ANY ONE)								
22CH2E1	Molecular Spectroscopy	4	0	0	DSE	30	70	4
22CH2E2	Instrumental methods of Analysis	4	0	0	DSE	30	70	4
22CH2E3	Analysis of foods & Drugs	4	0	0	DSE	30	70	4
LAB PRACTICALS								
22CH2L1	Physical chemistry Practical	0	6	0	Core	30	70	3
22CH2L2	Organic chemistry Practical-II	0	6	0	Core	30	70	3
TOTAL FOR SECOND SEMESTER						210	490	25
At the end of 2 nd semester, every student must undergo summer Internship/ Apprenticeship/Project work/Industrial training/Research based Project work for Six weeks and must prepare a report concerned as per approved project guidelines, and submit the same to the University 14 days before the commencement of third semester end examinations.								

III SEMESTER

Course	Course Name	Teaching Hours/ week	CORE /	Intern	Extern	No. of
--------	-------------	----------------------	--------	--------	--------	--------

Code		Lecture	Practical	Tutorial	IDC/DSE / SEC/OE C/MOOCs	al Marks	al Marks	Credits
22CH3T1	Organic Spectroscopy	4	0	0	Core	30	70	4
DOMAIN SPECIFIC ELECTIVE COURSES (CHOOSE ANY THREE)								
22CH3E1	Organic Reaction mechanism	4	0	0	DSE	30	70	4
22CH3E2	Organic Synthesis	4	0	0	DSE	30	70	4
22CH3E3	Natural Products	4	0	0	DSE	30	70	4
22CH3E4	Separation Techniques & Electro analytical techniques	4	0	0	DSE	30	70	4
22CH3E5	Marine Chemistry or Chemistry of Drugs	4	0	0	DSE	30	70	4
22CH3E6	Antibiotics, Drugs, Vitamins & Steroid hormones	4	0	0	DSE	30	70	4
LAB PRACTICALS								
22CH3L1	Organic Preparations	0	6	0	Core	30	70	3
22CH3L2	Organic Binary mixture Analysis.	0	6	0	Core	30	70	3
OPEN ELECTIVE (INTERDISCIPLINARY/MULTIDISCIPLINARY) COURSES (CHOOSE ANY ONE)								
22OE301	Polymer Chemistry	3	0	0	OEC	30	70	3
22OE302	Basic Bio Chemistry	3	0	0	OEC	30	70	3
22OE303	Basic Analytical Chemistry	3	0	0	OEC	30	70	3
		3	0	0	OEC	30	70	3
		3	0	0	OEC	30	70	3
TOTAL FOR III SEMESTER						210	490	25

IV SEMESTER

Course Code	Course Name	Teaching Hours/ week			CORE / IDC/DSE/ SEC/OE C/MOOCs	Internal Marks	External Marks	No. of Credits
		Lecture	Practical	Tutorial				
22CH4T1	Advanced Organic Spectroscopy	4	0	0	Core	30	70	4
DOMAIN SPECIFIC ELECTIVE COURSES (CHOOSE ANY THREE)								
22CH4E1	Green Chemistry	4	0	0	DSE	30	70	4
22CH4E2	Techniques for Modern Industrial applications	4	0	0	DSE	30	70	4
22CH4E3	Nano Chemistry	4	0	0	DSE	30	70	4
22CH4E5	Bio-organic chemistry	4	0	0	DSE	30	70	4
22CH4E6	Bio-Inorganic Chemistry	4	0	0	DSE	30	70	4
22CH4E7	Environmental chemistry	4	0	0	DSE	30	70	4
LAB PRACTICALS								
22CH4L1	Organic Estimations	0	6	0	Core	30	70	3
ENTREPRENEURIAL & INNOVATION/IT SKILL RELATED TO DOMAIN SPECIFIC ELECTIVE COURSES (CHOOSE ANY ONE)								
22CH4E8	Asymmetric Synthesis	3	0	0	SEC	30	70	3
22CH4E4	Organo metallic Chemistry	3	0	0	SEC	30	70	3
22CH4E9	Heterocyclic chemistry	3	0	0	SEC	30	70	3
* CHOOSE MOOCs FROM SWAYAM/NPTEL SOURCES								
MOOC S	22CH4M1							4
PROJECT WORK EVALUATION AND VIVA-VOCE -22CH4P1							100	4

TOTAL FOR IV SEMESTER	180	520	30
-----------------------	-----	-----	----

Note: Students may be allowed to register and appear for MOOCS from the third semester itself. However, students are to complete the MOOCS successfully and submit pass certificate of the same to the University through the Principal of the College concerned for approval and endorsement of the same on grade cards and PCs and ODs as per the regulations of the University.

Resolutions/ Recommendations

Resolution –I

1. It is resolved and recommended to implement the course structure as per R 22 regulations of KRU with necessary modifications as required.

Resolution –II

2. a) Resolved and recommended to implement the syllabus of course code 22CH1T1 of semester – I with 40% revision.
b) It is resolved and recommended to continue with the same syllabus for the course code 22CH1T2. However here after the course title will be referred as Inorganic chemistry instead of Inorganic chemistry – I.
c) It is resolved and recommended to continue with the same syllabus for the course code 22CH1T3. However Here after the course title will be referred as Introductory organic chemistry instead of Organic chemistry – I.
d) It is resolved and recommended to continue with the same syllabus for the course code 22CH1T4. However here after the course title will be referred as Physical chemistry instead of Physical chemistry – I.
e) It is resolved and recommended to implement the modified semester syllabus and model question papers for all the papers of first semester.

Resolution –III

3. Resolved and recommended to introduce the course outcomes in line with the guidelines of OBE following Bloom's Taxonomy for all the courses (both theory and practical) in semester – I of M.Sc (Chemistry) for the students admitted in the academic year 2022-23 and onwards.
4. Resolved to implement the revised syllabus for both theory and practicals with 40% revision for Semester-III students admitted in the year 2021-22. The courses of semester III are listed below.

Semester – III:

Paper	Title of the Paper	Code
Paper-I	Advanced Organic Spectroscopy	20CH3T1
Paper-II	Organic Reactions& Mechanisms	20CH3T2
Paper-III	Organic Synthesis	20CH3T3A
Paper-III	Asymmetric Synthesis, Phosphorus & Sulphur Reagents, Synthetic Polymers, Biomolecules & Bio organic Chemistry	20CH3T3B

Paper-IV	Environmental Chemistry and Analysis	20CH3T4A
Paper-IV	Chemistry of Natural Products	20CH3T4B
Pract-I	Organic Preparations	20CH3L1
Pract-II	Mixture Analysis	20CH3L2
Open Elective - II	Polymer Chemistry	20OECH- 2

V. J. V.

A.G.& S.G.SIDDHARTHADEGREE COLLEGE OF ARTS & SCIENCE

DEPARTMENT OF CHEMISTRY

M.Sc – CHEMISTRY (ORGANIC CHEMISTRY)

I SEMESTER

W.E.F 2022-23 (R22 Regulations)

Title of the Paper: GENERAL CHEMISTRY

Course Code	22CH1T1	Course Delivery Method	Class Room / Blended Mode -
Credits	4	CIA Marks	30
No. of Lecture Hours / Week	4	Semester End Exam Marks	70
Total Number of Lecture Hours	60	Total Marks	100
Year of Introduction :2017- 18	Year of Offering: 2022– 23	Year of Revision:2022-23	Percentage of Revision:40 %

S.No	COURSE OUTCOMES	PO'S
	After completion of the course, the student will be able to :	
1	Recollect the concepts of titrimetric analysis, statistical rules, visible spectrophotometry and group theory in chemistry	2
2	Identify the role of titrimetric analysis, specific statistical rules, microwave spectroscopy, Rotational vibrational spectroscopy and group theory in chemistry.	1,7
3	Demonstrate knowledge of titrometric analysis microwave spectroscopy, rotational vibrational	1,4
4	Test the conceptual knowledge gained in titrimetric analysis, statistical rules / principles, Microwave spectroscopy, rotational vibrational spectroscopy and group theory in chemistry	1,6

Syllabus

Course Details:-

Unit	Learning Units	Lecture Hours
I	Treatment of analytical data : Classification of errors – Determinate and indeterminate errors –Minimisation of errors – Accuracy and precision – Distribution of random errors – Gaussian distribution – Measures of central tendency – Measures of precision – Standard deviation – Standard error of mean – student's t test – Confidence interval of mean – Testing for significance – Comparison of two means – F – test – Criteria of rejection of an observation – propagation of errors – Significant figures and computation rules – Control charts – Regression analysis – Linear least squares analysis.	12
II	Titrimetric Analysis: Classification of reactions in titrimetric analysis- Primary and secondary standards-Neutralisation titrations-Theory of Neutralization indicators-Mixed indicators-Neutralisation curves-Displacement titrations-Precipitation titrations-Indicators for precipitation titrations-Volhard method-Mohr method- Theory of adsorption indicators-Oxidation reduction titrations-Change of electrode potentials during titration of Fe(II)	12

	with Ce(IV)- Detection of end point in redox titrations-Complexometric titrations- Metal ion indicators-Applications of EDTA titrations-Titration of cyanide with silver ion.	
III	Visible spectro photometry – Theory of spectrophotometry and colorimetry, Beer-Lambert's law - Deviations from Beers law. Classification of methods of colour measurement or comparison (standard series method, Duplication method, Dilution method, photoelectric-photometer method, spectrophotometer method)-Instrumentation – Applications-determination of phosphates, chlorides, Iron, Manganese, chromium - Photometric titrations-Spectrophotometric determination of pK value of an indicator.	12
IV	Symmetry and Group theory in Chemistry I Symmetry elements [Rotational axis of symmetry (C_n), Plane of Symmetry(σ) and Classification of planes of symmetry i.e., Vertical plane(σ_v) Dihedral Plane(σ_d) and Horizontal Plane(σ_h), Improperrotational axis of symmetry(S_n), Inversion centre or Centre of symmetry(i) and Identityelement(E)]. Identification of possible symmetry elements in the molecules H_2O , NH_3 , BF_3 , CH_4 , $[PtCl_4]^{-2}$, C_6H_6 , symmetry operation, Axioms of group theory- definition of group, sub group(Trivial and non-trivial sub groups), GMT tables- construction of GMT table Abelian(C_{2v}) and non abelian groups(C_{3v}), relation between order of a finite group and its sub group. Point symmetry group. Schoenflies symbols, Group generating elements, Classification of molecules- MLS, MHS, & MSS. Procedure to Find out Point group of a molecule (yes or no Method).	12
V	Symmetry and Group theory in Chemistry II Representation of groups by Matrices (representation for the C_n , C_{nv} , C_{nh} , D_n etc. groups to be worked out explicitly). Definition of Class and importance of similarity transformation in identifying symmetry class with c_{3v} as example, Character of a representation. Reducible and Irreducible representations - Mulliken notations for Irreducible representations The great orthogonality theorem (without proof) and its importance. Character tables and their use. Construction of Character table (C_{2v} and C_{3v} only). Application of group theory in IR and Raman spectroscopy taking H_2O , NH_3 , BF_3 examples. Mutual Exclusion principle with special reference to cis N_2F_2 and trans N_2F_2 .	12

Reference Books:

1. Vogel's text book of quantitative analysis. (3rd edition) Addition Wesley Longmann Inc.
2. Quantitative analysis R.A Day and A.L. Underwood. Prentice Hall Pvt. Ltd.
3. Fundamentals of Analytical Chemistry – Skoog and West
4. Instrumental Methods of analysis – B K Sharma.

Course Focus: Employability.

A.G.& S.G.SIDDHARTHA DEGREE COLLEGE OF ARTS & SCIENCE

DEPARTMENT OF CHEMISTRY

M.Sc – CHEMISTRY (ORGANIC CHEMISTRY)

I SEMESTER

W.E.F 2022-23 (R22 Regulations)

Title of the Paper: INORGANIC CHEMISTRY

Course Code	22CHIT2	Course Delivery Method	Class Room / Blended Mode
Credits	4	CIA Marks	30
No. of Lecture Hours / Week	4	Semester End Exam Marks	70
Total Number of Lecture Hours	60	Total Marks	100
Year of Introduction :2017-18	Year of Offering: 2022 - 23	Year of Revision: ----	Percentage of Revision: 0%

S.No	COURSE OUTCOMES	PO'S
	After completion of the course, the student will be able to :	
1	Memorize the basic concepts of quantum chemistry, co-ordination chemistry and chemical Bonding.	2
2	Comprehend the role of basic and advanced concepts of quantum chemistry, co-ordination chemistry and chemical bonding.	1,7
3	Execute the conceptual knowledge gained in the concepts of quantum chemistry, co-ordination chemistry and chemical bonding in chosen job role.	1,4
4	Investigate the role and importance of concepts of quantum chemistry, co-ordination chemistry and chemical bonding in various allied fields of chemistry.	1,7

Syllabus

Course Details

Unit	Learning Units	Lecture Hours
I	Introduction to Exact Quantum Mechanical Results: Schrodinger equation, importance of wave function, Operators, Eigen values and Eigen functions, derivation of wave equation using operator concept. Discussion of solutions of Schrodinger's equation to some model systems viz. particle in one dimensional box (applications), three-dimensional box, Rigid rotator system and the Hydrogen atom. Variation theorem, linear variation principle, perturbation theory (first order and non-degenerate), Application of variation method to the Hydrogen atom.	12
II	Chemistry of non- transition elements: Halogen oxides and oxyfluorides, Spectral and Magnetic properties of Lanthanides and Actinides. Analytical applications of Lanthanides and Actinides. Synthesis, properties and structure of B-N, S-N, P-N cyclic compounds. Intercalation compounds. Metal π- complexes: preparation, structure and bonding in Nitrosyl, Dinitrogen and Dioxygen complexes.	12
III	Structure and Bonding: $p\pi-d\pi$ bonding, Bent's rule, Non-valence cohesive forces, VSEPR theory. Molecular Orbital theory, Molecular orbitals in triatomic (BeH_2) molecules and ions (NO_2^-) and energy level diagrams. Walsh diagrams for linear (BeH_2) and bent (H_2O) molecules.	12

IV	Metal–ligand bonding: Crystal Field Theory of bonding in transition metal complexes-Splitting of d-orbitals in octahedral, tetrahedral, square planar, Trigonal bipyramidal and Square pyramidal fields. Tetragonal distortions - Jahn-Teller effect. Applications and limitations of CFT. Experimental evidences for covalence in complexes. Molecular Orbital Theory of bonding for Octahedral, tetrahedral and square planar complexes. π -bonding and MOT - Effect of π - donor and π -acceptor ligands on Δ_o . Experimental evidence for π - bonding in complexes.	12
V	Metal – ligand Equilibria in solutions: Step wise and over all formation constants. Trends in stepwise formation constants (statistical effect and statistical ratio). Determination of formation constants by Spectrophotometric method (Job's method) and pH metric method (Bjerrum's). Stability correlations - Irving -William's series. Hard and soft acids and bases (HSAB).	12

Reference Books:

1. Inorganic Chemistry Huheey, Harper and Row.
2. Physical methods in inorganic chemistry, R.S. Drago. Affiliated East-West Pvt. Ltd.
3. Concise inorganic chemistry, J. D. Lee, ELBS.
4. Modern Inorganic Chemistry, W. L. Jolly, McGrawHill.
5. Inorganic Chemistry , K. F. Purcell and J. C. Kotz Holt Saunders international.
6. Concepts and methods of inorganic chemistry, B. E. Douglas and D.H.M.C.
7. Daniel, oxford Press.
8. Introductory quantum mechanics , A. K. Chandra
9. Quantum Chemistry,R. K. Prasad.
10. Inorganic Chemistry ,Atkins, ELBS
11. Advanced Inorganic Chemistry ,Cotton and Wilkinson, Wiley Eastern
12. Quantum Chemistry, Levine.
13. Text book of Coordination chemistry ,K.SomaSekharrao and K.N.K. Vani, Kalyani Publishers.
14. Theoretical Inorganic Chemistry by G.S.Manku, Tata Mc GrawHill, 2000, reprint.
15. Concise co-ordination chemistry, R.Gopal, Ramalingam, Vikas Publishing, House, 2014.
16. Inorganic Chemistry – Huheey, A.Keiter, L.Keiter, 4th edition, Pearson education, Asia.

Course Focus: Employability.

A.G.& S.G.SIDDHARTHA DEGREE COLLEGE OF ARTS & SCIENCE

DEPARTMENT OF CHEMISTRY

M.Sc – CHEMISTRY (ORGANIC CHEMISTRY)

I SEMESTER

W.E.F 2022-23 (R22 Regulations)

Title of the Paper: ORGANIC CHEMISTRY

Course Code	22CH1T3	Course Delivery Method	Class Room / Blended Mode - Both
Credits	4	CIA Marks	30
No. of Lecture Hours / Week	4	Semester End Exam Marks	70
Total Number of Lecture Hours	60	Total Marks	100

S.No	COURSE OUTCOMES	PO'S
	After completion of the course, the student will be able to :	
1	Recollect the basic concepts of aromaticity, reactive intermediates, addition, elimination and Substitution reactions.	2
2	Explain the basic and advanced concepts of aromaticity, reactive intermediates, addition, elimination and substitution reactions.	2,7
3	Solve high level concepts in organic chemistry with conceptual knowledge gained in aromaticity, reactive intermediates, addition, elimination and substitution reactions.	1,7
4	Exercise the knowledge about aromaticity, reactive intermediates, addition, elimination and substitution reactions in understanding the properties of organic compounds.	1,5

Syllabus

Course Details

Unit	Learning Units	Lecture Hours
I	Nature of bonding: Localised and Delocalized, Delocalised chemical bonding conjugation, cross conjugation, hyper conjugation, Tautomerism. Aromaticity: Concept of Aromaticity, Aromaticity of five membered, six membered rings - Non benzenoid aromatic compounds:- cyclopropenyl cation, Cyclobutadienyldication, cyclopentadienyl anion-tropyllium cation and cyclooctatetraenyl dianion. Homoaromaticity, Anti aromaticity	12
II	Reactive intermediates & Reactive Species: Reactive intermediates: Generation, Structure, Stability, Detection and Reactivity of Carbocations, Carbanions, Free radicals, Carbenes, Nitrenes and Arynes. Reactive Species: Generation and reactivity of Electrophiles, Nucleophiles, Dienophiles, Ylids.	12
III	Addition Reactions: Additions: Addition to carbon – carbon multiple bonds, HX, X ₂ , HOX, stereo chemistry of addition, formation and reaction of epoxides, syn and anti hydroxylation, hydrogenation(catalytic and Non catalytic), synthetic reactions of CO and CN and Cram's rule.	12

IV	Eliminations Reactions: Types of elimination (E1, E1cB, E2) reactions, mechanisms, stereochemistry and orientation, Hofmann and Saytzeff's rules, Syn elimination versus anti elimination. Competitions between elimination and substitution. Dehydration, dehydrogenation, dehalogenation, decarboxylative elimination, pyrolytic eliminations.	12
V	Substitution Reactions: Aliphatic Nucleophilic substitutions: The SN ² , SN ¹ , mixed SN ¹ and SN ² and SN ⁱ reactions : Mechanism, effect of structure, nucleophile, leaving group on substitutions. The neighbouring group mechanism, participation by σ and π bonds, anchimeric assistance. Aromatic Nucleophilic substitution: The SN ^{Ar} (Addition – Elimination), SN ¹ (Ar) mechanisms and benzyne mechanism (Elimination – Addition). Reactivity- effect of substrate structure, leaving group and attacking nucleophile. The Von-Richter, Sommelet – Hauser and Smiles rearrangements.	12

Reference Books:

1. Advanced organic chemistry- Reaction, mechanism and structure, Jerry March, John Wiley.
2. Advanced organic chemistry, F.A. Carey and R.J. Sundberg, Springer, New York.
3. A guide book to Mechanism in organic chemistry, Peter Sykes, Longman.
4. Organic chemistry, I.L. Finar, Vol. I & II, Fifth ed. ELBS.
5. Organic chemistry, Hendrickson, Cram and Hammond (McGraw – Hill).
6. Modern organic Reactions, H.O. House, Benjamin.
7. Structure and mechanism in organic chemistry, C.K. Ingold, Cornell University Press.
8. Principles of organic synthesis, R.O.C. Norman and J.M. Coxon, Blakie Academic & Professional.
9. Reaction Mechanism in Organic Chemistry, S.M. Mukherji and S.P. Singh, Macmillan.
10. Basic Principles of Organic Chemistry by J. B. Roberts and M. Caserio.

Course Focus: Employability & Entrepreneurship

A.G.& S.G.SIDDHARTHA DEGREE COLLEGE OF ARTS & SCIENCE

DEPARTMENT OF CHEMISTRY

M.Sc – CHEMISTRY (ORGANIC CHEMISTRY)

I SEMESTER

W.E.F 2022-23 (R22 Regulations)

Title of the Paper: PHYSICAL CHEMISTRY

Course Code	22CH1T4	Course Delivery Method	Class Room / Blended Mode - Both
Credits	4	CIA Marks	30
No. of Lecture Hours / Week	4	Semester End Exam	70
Total Number of Lecture	60	Total Marks	100

S.No	COURSE OUTCOMES	PO'S
	After the completion of the course, Students will be able to	
1	Recall the basic concepts of thermodynamics, surface chemistry, electrochemistry, chemical Kinetics and potentiometry in detail.	2
2	Apply the spontaneous and non spontaneous reaction and derive various thermodynamic and Chemical kinetic derivations.	1,7
3	Describe the physical significance of thermodynamics, chemical kinetics and electrochemistry in Explaining the chemical properties and reactivity of molecules.	1,6
4	Analyse the important techniques of surfaces with the help of ESCA, Auger electron spectroscopy and potentiometric techniques of complexometric, neutralization, oxidation and reduction Titrations.	1,7

Syllabus

Course Details

Unit	Learning Units	Lecture Hours
I	Thermodynamics – I Classical thermodynamics - Brief review of first and second laws of thermodynamics - Entropy change in reversible and irreversible processes - Entropy of mixing of ideal gases - Entropy and disorder – Free energy functions - Gibbs-Helmholtz equation - Maxwell partial relations - Conditions of equilibrium and spontaneity - Free energy changes in chemical reactions: Van't Hoff reaction isotherm - Van't Hoff equation - Clausius Clapeyron equation - partial molar quantities - Chemical potential - Gibbs- Duhem equation - partial molar volume - determination of partial molar quantities - Fugacity - Determination of fugacity - Thermodynamic derivation of Raoult's law.	12
II	Surface phenomena and phase equilibria - Surface tension - capillary action - pressure difference - across curved surface (young - Laplace equation) - Vapour pressure of small droplets (Kelvin equation) - Gibbs-Adsorption equation - BET equation - Estimation of surface area - catalytic activity of surfaces – ESCA , X- ray fluorescence and Auger electron spectroscopy. Surface active agents - classification of surface active agents - Micellization - critical Micelle concentration (CMC) - factors affecting the CMC of surfactants, microemulsions - reverse micelles - Hydrophobic interaction.	12

III	Electrochemistry – I - Electrochemical cells - Measurement of EMF - Nernst equation – Equilibrium constant from EMF Data - pH and EMF data - concentration cells with and without transference – Liquid junction potential and its determination - Activity and activity coefficients - Determination by EMF Method - Determination of solubility product from EMF measurements. Debye Huckel limiting law and its verification. Effect of dilution on equivalent conductance of electrolytes - Anomalous behaviour of strong electrolytes. Debye Huckel-Onsagar equation - verification and limitations, conductometric titrations.	12
IV	Chemical kinetics - Methods of deriving rate laws - complex reactions - Rate expressions for opposing, parallel and consecutive reactions involving unimolecular steps. Theories of reaction rates - collision theory - Steric factor - Activated complex theory - Thermodynamic aspects – Unimolecular reactions - Lindemann's theory - Lindemann-Hinshelwood theory. Reactions in solutions - Influence of solvent - Primary and secondary salt effects - Elementary account of linear free energy relationships - Hammett - Taft equation - Chain reactions - Rate laws of H ₂ -Br ₂ , photochemical reaction of H ₂ - Cl ₂ , Decomposition of acetaldehyde and ethane - Rice-Herzfeld mechanism.	12
V	Potentiometry : Advantages of potentiometric methods - Reference electrode - Standard hydrogen electrode .Acid- alkali or Neutralisation titration, Oxidation – reduction titrations, Precipitation titrations, complexometric titrations, Methods of end point location (Graphical, Differentiation method, Pinkhof- Treadwell method). Calomel electrode -Indicator electrodes: Metal-metal ion electrodes - Inert electrodes -Membrane electrodes - theory of glass membrane potential - Direct potentiometry, potentiometric titrations - Applications.	12

Reference Books:

1. Physical chemistry, G.K.Vemulapalli (Prentice Hall of India).
2. Physical chemistry, P.W.Atkins. ELBS
3. Chemical kinetics - K.J.Laidler, McGraw Hill Pub.
4. Text book of Physical Chemistry, Samuel Glasstone, Macmillan pub.
5. Polymer Science, Gowriker, Viswanadham, Sreedhar
7. Elements of Nuclear Science, H.J.Arniker, Wiley Eastern Limited.
8. Quantitative Analysis, A.I. Vogel, Addison Wesley Longmann Inc.
9. Physical Chemistry-G.W.Castellan, Narosa Publishing House, Prentice Hall
10. Physical Chemistry, W.J.Moore, Prentice Hall
11. Polymer Chemistry – Billmeyer

Course Focus: Employability.

A.G.& S.G.SIDDHARTHA DEGREE COLLEGE OF ARTS & SCIENCE
DEPARTMENT OF CHEMISTRY
M.Sc – CHEMISTRY (ORGANIC CHEMISTRY)

I SEMESTER

W.E.F 2022-23 (R22 Regulations)

Title of the Paper: PERSONALITY DEVELOPMENT THROUGH LIFE ENLIGHTENMENT SKILLS

Course Code	22PG101	Course Delivery Method	Class Room / Blended Mode -
Credits	3	CIA Marks	30
No. of Lecture Hours / Practical Hours Week	3/1	Semester End Exam Marks	70
Total Number of Lecture Hours	60	Total Marks	100

The Course will introduce the students to

- 1) Learn to achieve the highest goal happily.
- 2) Become a person with stable mind, pleasing personality and determination.
- 3) Learn to build positive attitude, self-motivation, enhancing self-esteem and emotional intelligence
- 4) Learn to develop coping mechanism to manage stress through Yoga and meditation techniques
- 5) Awaken wisdom among them.

Course Learning Outcomes:

At the end of this course the students should be able to:

- Develop their personality and achieve their highest goals of life.
- Lead the nation and mankind to peace and prosperity
- Practice emotional self-regulation.
- Develop a positive approach to work and duties
- Develop a versatile personality

Syllabus

Course Details:-

Unit	Learning Units	Lecture Hours
I	Introduction to Personality Development:- The concept of personality - Dimensions of Personality – Theories of Personality development (Freud & Erickson) – The concept of Success and Failure – Factors responsible for Success – Hurdles in achieving Success and Overcoming Hurdles — Causes of failure – Conducting SWOT (Strengths, Weaknesses, Opportunities and Threats) analysis.	12

II	<p>Attitude, Motivation and Self-esteem:-Conceptual overview of Attitude – Types of Attitudes – Attitude Formation – Advantages/Disadvantages of Positive/Negative Attitude - Ways to Develop Positive Attitude.</p> <p>Concept of motivation: Definition and Nature of Motivation/Motive – Internal and external motives – Theories of Motivation – Importance of self- motivation-Factors leading to de- motivation.</p> <p>Self-esteem: - Definition and Nature of self-esteem – Do's and Don'ts to develop positive self- esteem – Low self esteem - Personality having low self esteem - Positive and negative self esteem.</p>	12
III	<p>Other Aspects of Personality Development:- Body language - Problem-solving - Conflict Management and Negotiation skills - Decision-making skills - Leadership and qualities of a successful leader – Character building -Team-work – Time management - Work ethics – Good manners and etiquette – Emotional Ability/Intelligence – Dimensions of Emotional Intelligence – Building Emotional Intelligence.</p>	12
IV	<p>Neetisatakam-Holistic Development of Personality: Verses- 19,20,21,22 (wisdom) – Verses- 29,31,32 (pride and heroism) – Verses- 26,28,63,65 (virtue)</p> <p>Personality of Role Model – Shrimad Bhagwadgeeta Chapter2-Verses 17 – Chapter 3-Verses 36,37,42 – Chapter 4-Verses 18, 38,39 – Chapter18 – Verses 37,38,63.</p>	12
V	<p>Yoga & Stress Management :Meaning and definition of Yoga - Historical Perspective of Yoga - Principles of Astanga Yoga by Patanjali – Meaning and Definition of Stress - Types of Stress - Eustress and Distress –Stress Management – Pranayama-Pranayama: Anulom and Vilom Pranayama - Nadishudhi Pranayama - Kapalabhati-Pranayama - Bhramari Pranayama - Nadasandhana Pranayama – Meditation techniques: Om Meditation - Cyclic meditation : Instant Relaxation technique (QRT), Quick Relaxation Technique (QRT), Deep Relaxation Technique (DRT) (Theory & Practical).</p>	12

PRACTICAL COMPONENTS:

- Students should identify different types of personality to know their own personality. Students are to describe the characteristics of their personalities and submit the same for assessment.
- Students are to form in groups (a group consists of 4-6 students) to identify and write a brief note on famous personalities of India andWorld.
- Students are required to identify different types of attitudes and give any five examples ofeach.
- Students are expected to check their attitudes and develop ways to improve their attitudes at work place andhome.
- Students are required to identify keys to self-motivation to achieve theirgoals.
- Students are expected to identify at least seven types of body language and conduct activities with thefollowing:

S. No.	Pose	Possible Interpretations
1	Standing with your hands on your hips	Aggressive, disgusted
2	Standing upright	Confidence
3	Arms crossed on your chest	Defensive
4	Resting your hand on your cheek	Thinking
5	Touching or rubbing your nose	Doubt, lying
6	Resting your head in your hands	Boredom, tired
7	Tapping your fingers	Impatience
8	Biting your nails	Nervous, insecure
9	Playing with your hair	Insecure
10	Rubbing your eyes	Disbelief, doubt

- **Conduct the following exercise to develop communication skills – Negotiation Skills and Empathy**

Exercise: Card Pieces

In this activity, team members trade pieces of playing cards to put together complete cards.

Uses -This exercise is useful for showing team members others' perspectives. It builds communication and negotiation skills, and helps people to develop empathy.

People and Materials

- Enough people for at least three teams of two.
- Playing cards – use between four and six for each person.
- A private room.

Time -
15 minutes.

Instructions:

1. Cut each playing card into half diagonally, then in half diagonally again, so you have four triangular pieces for each card.
2. Mix all the pieces together and put equal numbers of cards into as many envelopes as you have teams.
3. Divide people up into teams of three or four. You need at least three teams. If you're short of people, teams of two will work just as well.
4. Give each team an envelope of playing card pieces.
5. Each team has three minutes to sort its pieces, determine which ones it needs to make complete cards, and develop a bargaining strategy.
6. After three minutes, allow the teams to start bartering for pieces. People can barter on their own or collectively with their team. Give the teams eight minutes to barter.
7. When the time is up, count each team's completed cards. Whichever team has the most cards wins the round.

Advice for the Teacher/Facilitator

After the activity, ask your team members to think about the strategies they used. Discuss these questions:

- 1) Which negotiation strategies worked? Which didn't?
- 2) What could they have done better?
- 3) What other skills, such as active listening or empathy, did they need to use?

- **Conduct following Time management activity - Ribbon of Life**

Take a colored ribbon length of approximately 1 meter/100 cm. and scissors.
Start with the following questions:

1. If the life span of an individual is say, 100 years. Consider that each cm represents one year. The response will be that few live that long. Assuming a life of 75 to 90 years, cut 10 to 25 cm off the ribbon, accordingly.
2. What is the average age of the participants sitting here, the response would be 25 to 30 depending on the group, in that case, cut another 25 cms of the ribbon and say that is gone you cannot do anything.
3. What is left is 50 years? People will say, "Yes," but the answer is NO.
4. Every year we have 52 weeks, that is 52 Sundays. If we multiply that by 50 years, it comes to 7.14 years. Reduce the ribbon by another 7.14cm.
5. We also usually have Saturdays off, so reduce another 7.cms.
6. Public/National holidays are 10 multiple with 50 years. That comes to another 1.5 years. Reduce ribbon by another 1.5cms.
7. Your casual leave, sick leave, and annual holidays approx. 40 days a year, multiplied by 50. Cut off another 5 cms. Now you are left with about 29.5 years. But, the calculation is not over yet.
8. You sleep an average of 8 hours daily; multiply that by 365 days and again by 50 years (i.e. 122 days X 50 = almost 17 years). Cut off another 17cm.
9. You spend time eating lunch, breakfast, snacks, and dinner total 2 hours daily (i.e. 30 days a year X 50 years= 4 years or so). Cut off another 4cm.
10. Last, let's figure we spend about 1 hour a day travelling from place to place for activities and such. (that's about 2 more years). We're down to 6 (SIX) years of life to make it or break it.

Exercise Decision making skills - Create Your Own

In this exercise, teams must create their own, brand new, problem-solving activity.

Uses

This game encourages participants to think about the problem-solving process. It builds skills such as creativity, negotiation and decision making, as well as communication and time management. After the activity, teams should be better equipped to work together, and to think on their feet.

What You'll Need

- Ideally four or five people in each team.
- A large, private room.
Paper, pens and flipcharts

Time - Around one hour.

Instructions:

1. As the participants arrive, you announce that, rather than spending an hour on a problem-solving team building activity, they must design an original one of their own.
2. Divide participants into teams and tell them that they have to create a new problem-solving team building activity that will work well in their organization. The activity must not be one that they have already participated in or heard of.
3. After an hour, each team must present their new activity to everyone else, and outline its key benefits.
4. **Advice for the Teacher/Facilitator:**
There are four basic steps in problem solving: defining the problem, generating solutions, evaluating and selecting solutions, and implementing solutions. Help your team to think

creatively at each stage by getting them to consider a wide range of options. If ideas run dry, introduce an alternative brainstorming technique, such as brainwriting. This allows your people to develop one others' ideas, while everyone has an equal chance to contribute.

After the presentations, encourage teams to discuss the different decision-making processes they followed. You might ask them how they communicated and managed their time. Another question could be about how they kept their discussion focused. And to round up, you might ask them whether they would have changed their approach after hearing the other teams' presentations. Students are asked to recite verses: 26, 28, 63, 65 (virtue) of Neetisatakam - Holistic development of personality.

Students are asked to identify personality of role models from Shrimad Bhagwad Gita and portray the roles of the same.

Students are asked to practice Yoga and meditation techniques

REFERENCE BOOKS:

1. Hurlock, E.B. Personality Development, 28th Reprint. New Delhi: Tata McGraw Hill, 2006.
2. Gopinath, Rashtriya Sanskrit Sansthanam P, Bhartrihari's Three Satakam, Niti-sringar-vairagya, New Delhi, 2010
3. Swami Swarupananda, Srimad Bhagavad Gita, Advaita Ashram, Publication Department, Kolkata, 2016.
4. Lucas, Stephen. Art of Public Speaking. New Delhi. Tata - Mc-Graw Hill. 2001
5. Mile, D.J Power of positive thinking. Delhi. Rohan Book Company, (2004).
6. Pravesh Kumar. All about Self- Motivation. New Delhi. Goodwill Publishing House. 2005.
7. Smith, B. Body Language. Delhi: Rohan Book Company. 2004
8. Yogic Asanas for Group Training - Part-I: Janardhan Swami Yogabhyasi Mandal, Nagpur.
9. Rajayoga or Conquering the Internal Nature by Swami Vivekananda, Advaita Ashrama (Publication Department), Kolkata.
10. Nagendra H.R nad Nagaratna R, Yoga Perspective in Stress Management, Bangalore, Swami Vivekananda Yoga Prakashan.

Online Resources:

1. https://onlinecourses.nptel.ac.in/noc16_ge04/preview
2. <https://freevidelectures.com/course/3539/indian-philosophy/11>

A.G.& S.G.SIDDHARTHA DEGREE COLLEGE OF ARTS & SCIENCE

DEPARTMENT OF CHEMISTRY

M.Sc – CHEMISTRY (ORGANIC CHEMISTRY)

I SEMESTER

W.E.F 2022-23 (R22 Regulations)

Title of the Paper: Practical – I – Inorganic Chemistry Practical

(22CH1L1)

S.No	COURSE OUTCOMES	PO'S
	After completion of the course, the student will be able to :	
1	Memorize the basic principles involved in quantitative and qualitative inorganic analysis.	1,7
2	Understand the importance of inorganic qualitative and quantitative analysis and their use in research and industry.	2,6
3	Apply the procedures of quantitative analysis and tests for identification of cations and anions in chosen field.	1,5
4	Evaluate how far these methods are accurate in quantitative determination.	1,4

List of experiments:

1. Preparation of Potassium trisoxalato ferrate (III). (CO – 3, L - 3)
2. Preparation of Tris thiourea copper (1) sulphate. (CO – 4, L - 4)
3. Preparation of Cis and trans potassium diaquodioxalato chromate (III). (CO – 3, L - 3)
4. Preparation of Hexa ammine cobalt (III) chloride. (CO – 4, L - 4)
5. Determination of Zn^{2+} with potassium ferro cyanide. (CO – 3, L - 3)
6. Determination of Mg^{2+} using EDTA. (CO – 4, L - 4)
7. Determination of Ni^{2+} using EDTA. (CO – 3, L - 3)
8. Determination of hardness of water using EDTA. (CO – 4, L - 4)

9. Gravimetric determination of nickel using dimethyl glyoxime. (CO – 3, L - 3)
10. Gravimetric determination of Zn using diammonium hydrogen phosphate. (CO – 4, L - 4)
11. Semi micro qualitative analysis of six radical mixtures (CO – 4, L - 4)
(One interfering anion and one less familiar cation for each mixture)
(minimum three mixtures).

Anions: S^{2-} , SO_3^{2-} , Cl^- , Br^- , I^- , NO_3^- , SO_4^{2-} , CH_3COO^- , $C_2O_4^{2-}$, $C_4H_4O_6^{2-}$, PO_4^{3-} , CrO_4^{2-} , BO_3^{3-}

Cations: Ammonium (NH_4^+)

1st group: Ag^+ , Pb^{+2} , W^{+6}

2nd group: Pb^{+2} , Bi^{+3} , Cu^{+2} , Cd^{+2} , Sn^{+2} , Sn^{+4} , Mo^{+6} .

3rd group: Fe^{+2} , Fe^{+3} , Al^{+3} , Cr^{+3} , Ce^{+4} , Th^{+4} , Zr^{+4} , VO^{+2} , Be^{+2} .

4th group: Zn^{+2} , Mn^{+2} , Co^{+2} , Ni^{+2} .

5th group: Ca^{+2} , Ba^{+2} , Sr^{+2} .

6th group: Mg^{+2} , K^+ , Li^+ .

Text books/ Reference books:

1. Vogel's, "Quantitative chemical Analysis" J.Mendham, R.C.Denney, B.Sivasankar. 6th Edition.
2. Experimental Inorganic Chemistry, Dr.M.K.Shah.
3. Practical Inorganic Chemistry, Shikha Gulati, J.L.Sharma, ShagunManocha.
4. Vogel's, "Text book of macro and semimicro Qualitative inorganic Analysis" G.Svehla, 5th Edition.
5. Vogel's, "Text book of Quantitative Chemical Analysis" G.H.Jefery, 5th Edition.

A.G.& S.G.SIDDHARTHA DEGREE COLLEGE OF ARTS & SCIENCE

DEPARTMENT OF CHEMISTRY

M.Sc – CHEMISTRY (ORGANIC CHEMISTRY)

I SEMESTER

W.E.F 2022-23 (R22 Regulations)

Title of the Paper:Organic Practical-I (22CH1L2)

S.No	COURSE OUTCOMES	PO'S
	After completion of the course, the student will be able to :	
1	Understand the importance of organic compound synthesis and separation and their role in research and industry.	2,5,6
2	Understand the mechanisms for the synthesis of organic compounds in different steps.	1,7
3	Apply the procedure of synthesis and separation of organic compounds in required field.	1,5,7
4	Interpret the role of separation of organic compounds and synthesis in the core areas of research.	1,5,6

List of experiments:

1. Separation of Binary mixtures of Carboxylic acid + Neutral organic compounds (Solvent extraction method). (CO – 3, L - 3)
2. Separation of Binary mixtures of Basic nature + Neutral organic compounds (Solvent Extraction method). (CO – 3, L - 3)
3. Separation of Binary mixtures of Phenolic compounds + Neutral organic compounds (Solvent extraction method). (CO – 3, L - 3)
4. Preparation of Phthalimide from Phthalic anhydride – High Temperature. (CO – 3, L - 3)
5. Preparation of p-nitro acetanilide – Low temperature. (CO – 3, L - 3)
6. Preparation of Iodoform – Room temperature. (CO – 3, L - 3)
7. Paper chromatography - separate the given mixture of sugars. (CO – 4, L - 4)
8. Paper chromatography - separate the given mixture of amino acids. (CO – 4, L - 4)
9. Thin layer chromatography - separate the given mixture of phenols (CO – 4, L - 4)
10. Thin layer chromatography - separate the given mixture of 2,4-DNP derivatives of carbonyls compounds. (CO – 4, L - 4)

Text books/ Reference books:

1. A.I. Vogel, "A Text Book of Practical Organic Chemistry", Longman
2. A.I. Vogel, "Elementary Practical Organic Chemistry", Longman
3. F.G. Mann and B.C. Saunders, "Practical Organic Chemistry", Longman
4. Reaction and Synthesis in Organic Laboratory, B.S. Furniss, A.J. Hannaford, Tatchell, University Science Books mills valley.

5. Purification of Laboratory chemicals, manual, W.L.F. Armarego EDD Perrin
6. Reaction and Synthesis in Organic Chemistry Laboratory, Lutz-Friedjan- Tietze, Theophil Eicher, University Science Book.

A.G.& S.G.SIDDHARTHA DEGREE COLLEGE OF ARTS & SCIENCE
DEPARTMENT OF CHEMISTRY
M.Sc – CHEMISTRY (ORGANIC CHEMISTRY)
I SEMESTER

CIA Practicals

Total Marks – 30 M

We are assessing 10 marks for each practical. The scheme is as follows

Experiment – 6M

Observation– 2M

Result - 2M

We have no practical internal examination at the end of the each semester. However we consider 10 marks for each practical of total 10 practicals i.e (10 x 10M = 100M), then we reduce to 30M as internal practical marks.

M.Sc. DEGREE EXAMINATION

External Practical Model Paper

Time: 6 hours

Maximum Marks: 70

1. To write the principle and procedure / mechanism related to practical as listed in the practical syllabus – 5 M
2. Record – 10 M
3. Experiment (Procedure / Tabulation / calculation etc.) – 50 M
4. Result / Graphs / Yield / Report – 5

**M.Sc. DEGREE EXAMINATION
FIRST SEMESTER**

Paper-I :: General Chemistry

Time: 3 hours

Maximum Marks: 70

SECTION – A

Answer all the questions. Each question carries 4 marks.

(5x4M=20M)

1. (a) Discuss the role of control charts in large scale production. (CO-2, L - 2)
(Or)
(b) Elaborate the measures of accuracy? (CO-2, L - 2)
2. (a) Explain the terms primary & secondary standards in titrimetric analysis. (CO-2, L - 2)
(Or)
(b) Enumerate the significance of mixed indicators. (CO-2, L - 2)
3. (a) Give an account on classification of molecules in microwave spectroscopy. (CO-2, L-2)
(Or)
(b) Write a short note on degrees of freedom. (CO-2, L - 2)
4. (a) What are hot bands? (CO-2, L - 2)
(Or)
(b) Construct the group multiplication of C_{2v} point group (CO-2, L - 2)
5. (a) List out the possible symmetry elements and write the point group of the molecule HCHO. (CO-2, L - 2)
(Or)
(b) Define a class. Explain with an example. (CO-2, L - 2)

SECTION – B

(10x5=50M)

UNIT - I

6. (a) Write notes on determinate errors. (CO-2, L - 2)
(Or)
(b)(i) What are the criteria for rejection of an observation? (CO-2, L - 2)
(ii) Write notes on significant figures and computational rules. (CO-2, L - 2)

UNIT – II

7. (a) Explain the theory of neutralization indicators. (CO-2, L - 2)
(Or)
(b) Describe the Volhard & Mohr method in precipitation titrations. (CO-2, L - 2)

UNIT – III

8. (a) Explain the spectrophotometric determination of P_k value of an indicator. (CO-3, L - 3)
(Or)
(b) Discuss the procedure involved in the determination of phosphate ion and manganese. (CO-3, L - 3)

UNIT - IV

9. (a) Elaborate in detail the symmetry elements & symmetry operations with suitable examples and necessary theory. (CO-4, L - 4)
(Or)

(b)(i) Identify the possible symmetry elements in CH_4 & C_6H_6 molecules and analyze the point group. (CO-4, L- 4)

(ii) Analyze the classification of molecules basing on possible symmetry elements into MLS, MHS & MOS with examples. (CO-4, L-4)

UNIT - V

10 (a) Enumerate the role of group theory in IR & Raman spectroscopy. (CO-3, L-3)

(Or)

(b) Explain the construction of C_{2v} character table. . (CO-3, L- 3)

**M.Sc. DEGREE EXAMINATION
FIRST SEMESTER**

Paper-II :: Inorganic Chemistry

Time: 3 hours

Maximum Marks: 70

SECTION – A

Answer all the questions. Each question carries 4 marks. (5x4M=20M)

1. (a) Explain the significance of approximation methods. (CO-2, L - 2)
(Or)
(b) Define operator. Explain the significance of operators in quantum mechanics. (CO-2, L - 2)
2. (a) Discuss about Intercalation compounds. (CO-2, L - 2)
(Or)
(b) Enumerate the significance of natural oxygen carriers. (CO-2, L - 2)
3. (a) Explain the role of VSEPR theory in predicting the geometry of molecule. (CO-2, L - 2)
(Or)
(b) Give an account on important features of MO theory. (CO-2, L - 2)
4. (a) Explain the splitting of d-orbitals in square pyramidal crystal field. (CO-2, L - 2)
(Or)
(b) Discuss about crystal field stabilization energy. (CO-2, L - 2)
5. (a) Derive a relation between stepwise and overall formation constants. (CO-2, L - 2)
(Or)
(b) What is chelate effect? Explain with an example. (CO-2, L - 2)

SECTION – B (10x5=50M)

UNIT – I

6. (a) Write down the wave equation for rigid rotor and solve it to get eigen functions. (CO-3, L - 3)
(Or)
(b) Arrive at the expression for first order non degenerate eigen values of perturbation method. (CO-3, L - 3)

UNIT – II

7. (a) Write an account on phosphorus-nitrogen cyclic compounds. (CO-2, L - 2)
(Or)
(b) Explain the structure and bonding in nitrosyl complexes. (CO-2, L - 2)

UNIT – III

8. (a) Draw and explain the molecular orbital energy level diagram of BeH_2 molecule. (CO-3, L - 3)
(Or)
(b) Explain the evidences for $p\pi - d\pi$ bonding in non-transition metal compounds. (CO-3, L - 3)

UNIT - IV

9. (a) Justify the reason for tetragonal distortion in an octahedral complex with a suitable theory. (CO-4, L - 4)
(Or)
(b) Why CN^- and CO cause greater crystal field splitting and I⁻ and Br⁻ cause lesser crystal field splitting? Explain with necessary theory. (CO-L-4)

UNIT - V

10. (a) Describe the spectrophotometric method for the determination of stability Constant. (CO-2, L- 2)

(Or)

(b) Give a detailed account on HSAB theory. (CO-2, L- 2)

**M.Sc. DEGREE EXAMINATION
FIRST SEMESTER**

Paper-III : Organic Chemistry

Time: 3 hours

Maximum Marks: 70

SECTION – A

Answer all the questions. Each question carries 4 marks.

(5x4M=20M)

1. (a) Explain anti aromaticity with example. (CO-2, L - 2)
(Or)
(b) Explain cross conjugation with example. (CO-2, L - 2)
2. (a) Explain the structure of nitrenes. (CO-2, L - 2)
(Or)
(b) Discuss the structure of carbenes. (CO-2, L - 2)
3. (a) Discuss cram's rule with suitable examples. (CO-2, L - 2)
(Or)
(b) Write notes on epoxidation. (CO-2, L - 2)
4. (a) Define Hoffmann's rule. Give suitable examples. (CO-2, L - 2)
(Or)
(b) Discuss syn elimination versus anti elimination. (CO-2, L - 2)
5. (a) Give mechanism of Von-Richter rearrangement. (CO-2, L - 2)
(Or)
(b) Write noters on S_Ni mechanism. (CO-2, L - 2)

SECTION – B

(10x5=50M)

UNIT - I

6. a) Define delocalized chemical bonding. What are different types of delocalized chemical bonding. (CO - 2, L - 2)
(Or)
b) Explain the following terms (i) Cross Conjugation (ii)Hyper Conjugation. (CO - 2, L - 2)

UNIT - II

7. a) Discuss the generation, stability and reactivity of carbocations. (CO -2, L - 2)
(Or)
b) Explain synthesis and few reactions of the following
(i) Free radicals (ii) Carbanions (CO - 2, L - 2)

UNIT - III

8. a) Give an account of the addition of the following to carbon carbon multiple bonds
(i) HX (ii) HOX (CO - 2, L - 2)

(Or)

- b) Discuss in detail about the following
(i) Syn and Anti hydroxylation (ii) Hydrogenation (CO -2, L - 2)

UNIT – IV

9. a) Discuss pyrolytic eliminations and its orientation. (CO -2, L - 2)
(Or)
b) Write a detailed account of E1CB mechanism. (CO -2, L - 2)

UNIT – V

10. a) What is anchimeric assistance. Discuss neighboring group participation by σ and π bonds with suitable examples. (CO -4, L - 4)

(Or)

- b) Explain the following (i) Benzene mechanism (ii) S_N^{Ar} mechanism with applications.

(CO -4, L - 4)

**M.Sc. DEGREE EXAMINATION
FIRST SEMESTER**

Paper-IV: Physical Chemistry

Time: 3 hours

Maximum Marks: 70

SECTION – A

Answer all the questions. Each question carries 4 marks.

(5x4M=20M)

1. (a) Explain the second law of thermodynamics. (CO-2, L - 2)
(Or)
(b) Write the Gibbs Duham equation and describe all the terms present. (CO-2, L - 2)
2. (a) Discuss briefly the surface active agents. (CO-2, L - 2)
(Or)
(b) Explain the micro emulsions in brief. (CO-2, L - 2)
3. (a) Write the Nernst equation and describe all the terms present in it. (CO-2, L - 2)
(Or)
(c) Explain the principle in conductometric titrations. (CO-2, L - 2)
4. (a) Write the mechanism in Lindemann's theory of unimolecular reactions. (CO-2, L - 2)
(Or)
(b) Describe the mechanism in decomposition of Acetaldehyde. (CO-2, L - 2)
5. (a) Describe the advantages of potentiometric methods over classical methods. (CO-2, L - 2)
(Or)
(b) Explain the calomel electrode in short. (CO-2, L - 2)

SECTION – B

(10x5=50M)

UNIT - I

6. (a) Derive the Maxwell's thermodynamic relations. (CO-2, L - 2) (Or)
(b) What is fugacity? Give its physical significance. Describe the different methods of determination of fugacity. (CO-2, L - 2)

UNIT - II

7. (a) Discuss the theory involved in ESCA. How are these techniques used in the analysis of surfaces? (CO-2, L - 2)
(Or)

- (b) What is CMC? How is it determined? What are the factors affecting CMC? (CO-2, L - 2)

UNIT - III

8. (a) What is activity? How is activity coefficient determined from EMF? (CO-2, L - 2)

(Or)

- (b) What is the effect of dilution on equivalent conductance of electrolytes? (CO-2, L - 2)

UNIT – IV

9. (A) Discuss and analyze the kinetics of consecutive reactions. (CO-4, L - 4)

(Or)

- (b) Discuss and analyze the kinetics of $H_2 - Br_2$ reaction in detail. (CO-4, L - 4)

UNIT – V

10. (a) Explain the theory of precipitation titrations in detail. (CO-2, L - 2)

(Or)

- (b) Discuss the potentiometric titrations in detail. (CO-2, L - 2)

A.G.& S.G. SIDDHARTHA DEGREE COLLEGE OF ARTS & SCIENCE

Vuyyuru- 521165.

NAAC reaccredited at 'A' level

Autonomous -ISO 9001 – 2015 Certified

Title of the Paper: ADVANCED ORGANIC SPECTROSCOPY

Semester: III

Course Code	20CH3T1	Course Delivery Method	Class Room / Blended Mode - Both
Credits	4	CIA Marks	30
No. of Lecture Hours / Week	4	Semester End Exam Marks	70
Total Number of Lecture Hours	60	Total Marks	100
Year of Introduction :2020-21	Year of Offering: 2021 - 22	Year of Revision: ----	Percentage of Revision: 0%

Course Objective: The main objective of this paper is to give a basic and updated knowledge for the student on Proton & ^{13}C NMR Spectroscopy, Structural Elucidation of Organic compounds Using UV, IR, ^1H -NMR, ^{13}C -NMR, 2D NMR spectroscopy and Optical Rotatory Dispersion (ORD) & CD spectroscopy.

Course Outcomes:-

CO1: Summarize the principle, theory and advanced aspects of ^1H NMR, ^{13}C NMR, 2DNMR, ORD & CD spectroscopic techniques.

CO2: Display the knowledge gained in the areas of ^1H NMR, ^{13}C NMR, 2DNMR, ORD & CD Spectroscopic techniques in chosen job role.

CO3: Interpret the spectral data of ^1H NMR, ^{13}C NMR, 2DNMR, ORD & CD in elucidating the Structure of the molecule.

CO4: Assess that how far the spectral data of ^1H NMR, ^{13}C NMR, 2DNMR, ORD & CD are useful in establishing the structure of the molecule.

Syllabus

Course Details:-

Unit	Learning Units	Lecture Hours
I	<p>Proton NMR Spectroscopy: Determination of structure of organic compounds using PMR data. Spin system, Nomenclature of spin system, spin system of simple and complex PMR spectrum (Study of AB – A2 – AB2. ABX – ABC – AMX interactions) Simplification of complex spectra- nuclear magnetic double resonance, chemical shift reagents, solvent effects on PMR Spectrum . Nuclear Overhauser Effect (NOE).</p>	12
II	<p>13C-NMR spectroscopy: Similarities and Difference between PMR and CMR-CMR recording techniques -BBC-BBD-SFORD-Gate pulse CMR spectrum. General considerations, chemical shift (aliphatic, olefinic, alkyne, aromatic, heteroaromatic and carbonylcarbon), coupling constants. Typical examples of CMR spectroscopy – simple problems.</p>	12
III	<p>ORD& CD Curves: Optical rotatory dispersion : Theory of optical rotatory dispersion – Cotton effect –CD curves-types of ORD and CD curves-similarities and difference between ORD and CD curves. α- Halo keto rule. Octant rule – application in structural studies.</p>	12
IV	<p>2D NMR spectroscopy: Definitions and importance of COSY, DEPT, HOMCOR, HETCOR,INADEQUATE, INDOR, INEPT, NOESY, HOM2DJ, HET2DJ. Study of COSY ,DEPT, HOMCOR, HETCOR, INADEQUATE INDOR INEPT ,NOESY HOM2DJ, HET2DJ, taking simple organic compounds as examples.</p>	12
V	<p>Structural Elucidation of Organic compounds Using UV, IR, 1H-NMR, 13C-NMR and Mass spectroscopy.</p>	12

Reference Books:

1. Introduction to Spectroscopy – D. L. Pavia, G.M. Lampman, G. S. Kriz, 3rdEd. (Harcourt College publishers).
2. Spectrometric identification of organic compounds R. M. Silverstein, F. X. Webster, 6th Ed. John Wiley and Sons.
3. Spectroscopic methods in organic chemistry - D. H. Williams and I Flemming McGraw Hill, 4th edition.
4. Absorption spectroscopy of organic molecules – V. M. Parikh
5. Organic structural Spectroscopy- Joseph B. Lambert, Shurvell, Lightner, Cooks, Prentice-Hall (1998).
6. Organic structures from spectra –Field L.D., Kalman J.R. and Sternhell S. 4thEd. John Wiley and sons Ltd.
7. Organic spectroscopy – Principle & Applications – Jag Mohan, Narosa, 2nd edition, Publishinghouse.

Course Focus: Employability & Entrepreneurship.

A.G. & S.G. SIDDHARTHA DEGREE COLLEGE OF ARTS & SCIENCE

Vuyyuru-521165.

NAAC reaccredited at 'A' level

Autonomous -ISO 9001 – 2015 Certified

Title of the Paper: ORGANIC REACTIONS & MECHANISMS

Semester: III

Course Code	20CH3T2	Course Delivery Method	Class Room / Blended Mode - Both
Credits	4	CIA Marks	30
No. of Lecture Hours / Week	4	Semester End Exam Marks	70
Total Number of Lecture Hours	60	Total Marks	100
Year of Introduction :2020-21	Year of Offering: 2021 - 22	Year of Revision: ----	Percentage of Revision: 0

Course Objective: The main objective of this paper is to give a basic and updated knowledge for the students on Oxidations, Reductions, Molecular Rearrangements, Pericyclic Reactions and Organic Photo Chemistry.

Course Outcomes:-

- CO1 :** Acquire sound knowledge of oxidations, reductions, molecular rearrangements, pericyclic reactions and photochemistry.
- CO2 :** Understand the concepts involved in oxidations, reductions, molecular rearrangements, pericyclic reactions and photochemistry.
- CO3 :** Apply the conceptual knowledge gained in oxidations, reductions, molecular rearrangements, pericyclic reactions and photo chemistry in chosen fields.
- CO4 :** Analyse and categorise the various types oxidations, reductions, molecular rearrangements, pericyclic reactions and photo chemistry in a given reactions.

Syllabus

Course Details

Unit	Learning Units	Lecture Hours
I	Oxidations Definition and types of Oxidations, oxidations with ruthenium tetroxide, NBS, iodobenzene diacetate, Tl(III) nitrate, Chromium (VI) oxidants, Lead tetra acetate, SeO ₂ , MnO ₂ , Ag ₂ CO ₃ , Oppenauer oxidation, perhydroxylation using KMnO ₄ , OsO ₄ , HIO ₄ , oxidation with iodine silver carboxylate (Woodward and Prevost conditions), Definition & mechanism of epoxidation by peracids.	12

II	<p>Reductions</p> <p>Definition and types of reductions, reduction by dissolving metals - Reduction with metal and liquid ammonia (Birch Reduction of aromatic compounds), Reduction with metal acid - Clemensons reduction, Reduction by hydride transfer reagents, Aluminiumalkoxide - MeerweinPondorfVerley Reduction, LiAlH₄, NaBH₄, Diisobutylaluminiumhydride(DIBAL), Sodium cyanoborohydride, trialkyl borohydrides, Reduction with diimide, Wolff-Kishnerreduction.</p>	12
III	<p>Molecular Rearrangements</p> <p>Migration to electron deficient carbon atom. Pinacole-Pinacolone rearrangement, Wagner-Meerwein rearrangement, Dienone-Phenol rearrangement, Benzil-Benzilic acid rearrangement, Favorski rearrangement, ARNDT Eistert rearrangement, Sommelet – Hauser rearrangement.</p> <p>Migration to electron deficient hetero atom: Wolf, Hofmann, Curtius, Lossen, Schmidt, Beckmann rearrangement, Baeyer-Villiger rearrangement, Stevens, Neber rearrangements. Fries, Fischer-Hepp, Orton, Bamberger, Dakin, Cumene Hydroperoxide rearrangement.</p>	12
IV	<p>Pericyclic Reactions – I:</p> <p>Definition, classification of pericyclic reactions, Molecular Orbital energy level diagrams, electronic configuration in ground and first excited states of Ethylene, 1,3-Butadiene, 1,3,5 – Hexatriene, allyl system, stereo chemical notations – suprafacial, antarafacial, conrotatory and disrotatory modes, Woodward and Hoffmann selection rules.</p> <p>Electrocyclic reactions: Mechanism, Stereochemistry of (4n) and (4n+2) π systems. PMO, FMO and correlation methods.</p> <p>Cyclo additions: Mechanism, stereochemistry of (2+2) and (4+2) π systems, PMO, FMO and correlation methods.</p> <p>Sigmatropic rearrangements: Classification, mechanism for FMO and PMO approach under thermal and photo chemical conditions. (Detailed treatment of Claisen, Cope rearrangements fluxional molecules, aza-cope rearrangements).</p>	12
V	<p>Photochemistry:</p> <p>Photochemical processes: Energy transfer, sensitization and quenching. Singlet and triplet states and their reactivity. Photochemistry of olefins – conjugated olefins, Aromatic compounds – isomerisation – additions. Photochemistry of carbonyl compounds – Norrish type I and II reactions – Paterno – Buchi Reaction.</p> <p>Photoreduction, Photochemical rearrangements – Photo Fries rearrangement, Di-π-methane rearrangement, Barton reaction.</p>	12

Reference Books:

1. Molecular reactions and Photochemistry by Charles Dupey and O. Chapman, PrenticeHall.
2. Reaction mechanism in organic chemistry. 3rd edition, S.M.Mukherji&singh.
3. Advanced Organic Chemistry-Reactions, Mechanisms and Structure, Jerry March, John Wiley and sons, 6thedition.
4. Advanced Organic Chemistry, F.A. Carey and R.J Sundberg,Plenum.
5. Modern methods of organic synthesis, Cambridge University press, 3rd edition,W.Carruthers.
6. Organic Reaction Mechanisms, V.K.Ahluwalia, 4th edition,Narosa.
7. Reactions, rearrangements and reagents.S.N.Sanyal,4thedition.
8. Organic Photo chemistry and Pericyclic reactions' M.G.AroraAnmol Publications Pvt.Ltd.
9. Fundamentals of Photochemistry by K.K.Rohatgi–Mukherjee New Age internationalpublishers.

Course Focus: Employability &Entrepreneurship.

A.G. & S.G. SIDDHARTHA DEGREE COLLEGE OF ARTS & SCIENCE

Vuyyuru-521165.

NAAC reaccredited at 'A' level

Autonomous -ISO 9001 – 2015 Certified

Title of the Paper: ORGANIC SYNTHESIS

Semester: III

Course Code	20CH3T3A	Course Delivery Method	Class Room / Blended Mode - Both
Credits	4	CIA Marks	30
No. of Lecture Hours / Week	4	Semester End Exam Marks	70
Total Number of Lecture Hours	60	Total Marks	100
Year of Introduction :2020-21	Year of Offering: 2021 - 22	Year of Revision: -----	Percentage of Revision: 0%

Course Objective: The main objective of this paper is to give a basic and updated knowledge for the students on Formation of C-C single & double bonds, Diels-Alder and related reactions, Retro Synthetic Analysis and Protecting Groups.

Course Outcomes:

- CO1 :** Memorize the concepts, principles and theories related to formation of C – C single bond, C – C double bond, Diel's Alder related reactions. Protecting groups and disconnection approach in organic synthesis.
- CO2 :** Understand the role and significance of formation of C – C single bond, C – C double bond, Diel's Alder related reactions. Protecting groups and disconnection approach in organic synthesis.
- CO3 :** Apply the conceptual knowledge gained in formation of C – C single bond, C – C double bond, Diel's Alder related reactions. Protecting groups and disconnection approach in organic synthesis as and when required.
- CO4 :** Analyze the role of various reagents in carrying out the organic reactions like formation of C – C single bond, C – C double bond, Diel's Alder related reactions. Protecting groups and disconnection approach in organic synthesis.

Syllabus

Course Details

Unit	Learning Units	Lecture Hours
I	Formation of carbon-carbon single bonds: Alkylation of relatively acidic methylene groups, alkylation of ketones, enamine and related reactions, umplong (dipole inversion). Allylic alkylation of alkenes, alkylation of α -thiocarbanions- α - selenocarbanions, formation of carbon carbon single bonds by the addition of free radicals to alkenes, synthetic applications of carbenes and carbenoids.	12

II	<p>Formation of carbon-carbon double bonds</p> <p>Pyrolytic syn elimination reactions sulphoxide-sulphonate rearrangement, synthesis of allyl alcohols, the witting reaction, alkenes from sulphones, decarboxylation of β-lactones, alkenes from aryl sulphonyl hydrazones.</p> <p>Stereo selective synthesis of tri and tetra substituted alkenes, oxidative decarboxylation of carboxylic acids, stereospecific synthesis from 1,2-diols, reductive dimerization of carbonyl compounds.</p>	12
III	<p>Diels-Alder and related reactions: The dienophile, heterodienophile, oxygen as dienophile, The diene, acyclic dienes, heterodienes, 1,2-dimethylene cycloalkanes, vinyl cycloalkenes, and vinyl arenes, cyclic dienes and furans.</p> <p>Intra molecular Diels -Alder reactions, stereochemistry and mechanism of Diels - Alder reaction, retro Diels - Alder reaction, catalysis by lewis acids, photosensitized Diels- Alder reactions and 1,3-dipolar cycloaddition reactions, the ene reaction.</p>	12
IV	<p>Disconnection approach</p> <p>Introduction to Retro-synthetic analysis, Disconnection approach with suitable examples, Definitions: FGI, Disconnection, synthons, synthetic equivalent, reagent, target molecule, General strategy: choosing a disconnection, greatest simplification, symmetry, high yielding steps, recognizable starting materials.</p> <p>Chemo, regio and stereo selectivity with examples. One group C-C disconnections-Alcohols, carbonyl compounds, alkene synthesis, two group disconnections: 1,3 - dicarbonyl compounds, α,β - unsaturated carbonyl compounds.</p>	12
V	<p>Protecting groups:</p> <p>Theory and importance of functional group protection and deprotection in organic synthesis:-Protecting agents for the protection of functional groups: Hydroxyl group, Amino group, Carbonyl group and Carboxylic acid group</p> <p>carbon-carbon multiple bonds; chemo- and regioselective protection and deprotection. Illustration of protection and deprotection in organic synthesis.</p>	12

Reference Books:

1. Modern methods of Organic synthesis ,W. Carruthers Cambridge Press (3rdedition)
2. Principles of Organic synthesis by, ROC Norman, 3rd edition, CRCpress.
3. Modern Method of Organic Synthesis ,Carruthers and ColdhamSachinkumar Ghosh, Cambridge New Central Book Agency,1stedition.
4. Advances in Organic Reaction mechanism and structure, J. March, 6th edition, McGrewHill
5. Organic Synthesis: Ratnakumarkar, vol – II, NCBAPublications.

Course Focus: Employability &Entrepreneurshi

A.G. & S.G. SIDDHARTHA DEGREE COLLEGE OF ARTS & SCIENCE

Vuyyuru-521165.

NAAC reaccredited at 'A' level

Autonomous -ISO 9001 – 2015 Certified

Title of the Paper: CHEMISTRY OF NATURAL PRODUCTS

Semester: III

Course Code	20CH3T4B	Course Delivery Method	Class Room / Blended Mode - Both
Credits	4	CIA Marks	30
No. of Lecture Hours / Week	4	Semester End Exam Marks	70
Total Number of Lecture Hours	60	Total Marks	100
Year of Introduction : 2020-2021	Year of Offering: 2021 - 22	Year of Revision: -----	Percentage of Revision: 0%

Course Objective: The main objective of this paper is to give a basic and updated knowledge for the students on Alkaloids, Terpenoids, Steroids, Flavonoids, Isoflavonoids and Plant pigments.

Course Outcomes:-

CO1 :Memorize the concepts related to Alkaloids, Terpenoids, Steroids, Flavonoids and Isoflavonoids and Pigments.

CO2 :Understand the chemical role of Alkaloids, Terpenoids, Steroids, Flavonoids and Isoflavonoids and Pigments.

CO3 :Execute the conceptual knowledge gained in the areas of Alkaloids, Terpenoids, Steroids, Flavonoids and Isoflavonoids and Pigments.

CO4 :Analyze the role of methods involved in structure elucidation of Alkaloids, Terpenoids, Steroids, Flavonoids and Isoflavonoids and Pigments.

Syllabus

Course Details

Unit	Learning Units	Lecture Hours
I	Alkaloids: Introduction, Definition, occurrence, role of alkaloids in plants, classification, isolation and general methods for structural elucidation of alkaloids. Structure elucidation of Morphine, Quinine.	12
II	Terpenoids: Introduction, Definition, nomenclature, classification, isolation, isoprene rule and general methods for structural elucidation of Terpenoids. Structure elucidation of Zingiberene, , farnesol.	12
III	Steroids: Introduction, Definition, nomenclature, classification. Occurrence, isolation, physiological action, structure elucidation of Androsterone, Progesterone.	12
IV	Flavonoids and Isoflavonoids: Introduction, Definition, classification, isolation, physiological action, structure elucidation of Kaempferol and Quercetin.	12
V	Pigments: Introduction, classification of natural pigments, introduction and classification of carotenoids, functions of carotenoids in plants and animals, structure and synthesis of α – carotene and β – carotene.	12

Reference Books:

1. Organic Chemistry, Vol:2, I.L.Finar, 5th Edition.
2. Chemistry of Natural Products, K. W. Bentley, Oxford at the Clarendon Press, 1st edition.
3. Chemistry of Natural Products by P. S. Kalsi Kalyani Publishers. 1983, low cost university edition.
4. Chemistry and physiology of alkaloids by Manske Vol. I & II, VII, Academic Press Inc., publishers New York, 1st edition.

Course Focus: Employability & Entrepreneurship.

A.G. & S.G. SIDDHARTHA DEGREE COLLEGE OF ARTS & SCIENCE

Vuyyru-521165 NAAC

reaccredited at 'A' level

Autonomous -ISO 9001 – 2015 Certified

Title of the Paper: POLYMER CHEMISTRY

Semester: III

Course Code	20OECH	Course Delivery Method	Class Room / Blended Mode - Both
Credits	4	CIA Marks	30
No. of Lecture Hours / Week	4	Semester End Exam Marks	70
Total Number of Lecture Hours	60	Total Marks	100
Year of Introduction : 2021 - 22	Year of Offering: 2021 - 22	Year of Revision: ----	Percentage of Revision: ----

Course Objective: The main objective of this paper is to give a basic and updated knowledge for the students on Polymer chemistry.

Course Outcomes:

CO1 : Memorize the concepts related to polymer chemistry

CO2 : Understand the concepts of polymer chemistry

CO3 : Apply the knowledge gained in polymer chemistry in chosen job role.

Syllabus

Course Details

Unit	Learning Units	Lecture Hours
I	Introduction, Classification of polymers, Polymerization, chain polymerization, step polymerization, Co polymerization, Free radical chain polymerization, cationic polymerization, anionic polymerization, Polymerization Techniques, Graft and Block Copolymers.	12
II	Polymer Synthesis, Isolation and Purification of polymers, Polymer Fractionation, Molecular weight determination, Molecular weight determination curve, Processing Techniques.	12
III	Polymer Reactions—Introduction, Hydrolysis, Acidolysis, Aminolysis, Hydrogenation, Addition and Substitution Reactions, Cyclisation reactions, Cross-linking Reactions.	12

IV	Polymer Degradation – Definition, Types of Degradation, Thermal Degradation, Mechanical Degradation, Degradation by Ultrasonic Waves, Photodegradation, Degradation by High-Energy Radiation, Oxidative Degradation, Hydrolytic Degradation.	12
V	Plastics, Fibres, Elastomers-Polyethylene, Polystyrene, PolyEsters, PolyAcrylonitrile, Polyurethanes, Polyvinyl Chloride, Polyisoprenes. Resins–Phenol Formaldehyde Resin, Urea Formaldehyde and Melamine–Formaldehyde Resins,Epoxy Polymers, Silicon Polymers.	12

Reference Books:

1. Textbook of Polymer Science byFrod,W.Billmayer,
2. An Introduction to Polymer Chemistry byMoore.
3. Polymer Chemistry-An Introduction byM.P.Stevens.
4. Polymer Science –VRGowariker, NVViswanathan,JayadevSreedhar.

Course Focus : Employability .

A.G.& S.G. SIDDHARTHA DEGREE COLLEGE OF ARTS & SCIENCE

Vuyyuru-521165.

NAAC reaccredited at 'A' level

Autonomous -ISO 9001 – 2015 Certified

Title of the Paper: ORGANIC PREPARATIONS

Semester: III

Course Code	20CH3L1	Course Delivery Method	Class Room / Blended Mode - Both
Credits	4	CIA Marks	30
No. of Lecture Hours / Week	4	Semester End Exam Marks	70
Total Number of Lecture Hours	60	Total Marks	100
Year of Introduction :2020-21	Year of Offering: 2021 - 22	Year of Revision: ----	Percentage of Revision:0%

Course Objective: The main objective of this paper is to give a basic and updated knowledge for the students on organic chemistry practical.

Course Outcomes:-

CO1: Memorize the principle involved in various organic preparations.

CO2: Understand the mechanism involved in organic preparation.

CO3: Apply the knowledge of organic preparations in their chosen field.

Syllabus

Course Details:-

1. Preparation of organic compounds: Three stage preparations by reactions involving nitration, halogenation, oxidation, reduction, alkylation, acylation, condensation and rearrangement. (A student is expected to prepare at least five different organic compounds by making use of the reactions given above).
2. Green Procedures for organic compound preparations (atleast 5preparations).

Course Focus: Skill Development & Employability

A.G.& S.G. SIDDHARTHA DEGREE COLLEGE OF ARTS & SCIENCE

Vuyyuru- 521165.

NAAC reaccredited at 'A' level

Autonomous -ISO 9001 – 2015 Certified

Title of the Paper: Mixture Analysis

Semester: III

Course Code	20CH3L2	Course Delivery Method	Class Room / Blended Mode - Both
Credits	4	CIA Marks	30
No. of Lecture Hours / Week	4	Semester End Exam Marks	70
Total Number of Lecture Hours	60	Total Marks	100
Year of Introduction :2020-21	Year of Offering: 2021 - 22	Year of Revision: ----	Percentage of Revision: 0 %

Course Objective: The main objective of this paper is to give a basic and updated knowledge for the students on Analysis of organic binary mixtures.

Course Outcomes:-

CO1 :Get familiarized with the tests involved to identification of various functional groups.

CO2 :Understand the theory involved in identification and separation of the given organic mixture based on the solubility

CO3 :Apply the knowledge to identify various functional groups present in the given organic compound by using a systematic procedure.

Syllabus

Course Details:-

Analysis of organic binary mixtures: Separation and identification of organic binary mixtures (The students must be given training in at least 10 mixtures with different functional groups).

Note: For semester end examinations the student has to submit at least two solid derivatives for each individual component.

Course Focus: Skill Development & Employability

**M.Sc. DEGREE EXAMINATION
THIRD SEMESTER
Paper-I:: ADVANCED ORGANIC SPECTROSCOPY**

Time:3hours

Maximum Marks:70

SECTION – A

Answer all the questions. Each question carries 2 marks. (10x2M=20M)

1. a) Explain the importance of Double irradiation. (CO-1)
- b) Write a short note on nomenclature of spin systems. (CO-1)
- c) Explain the α , β & γ effects in ^{13}C NMR with suitable examples. (CO-1)
- d) Discuss the importance of off resonance decoupling CMR spectrum. (CO-1)
- e) What is Cotton effect? (CO-1)
- f) Predict the sign of cotton effect in 3-methyl cyclohexanone when substituent is in equatorial position. (CO-1)
- g) What information is possible from the COSY experiment? (CO-2)
- h) Discuss about various periods involved in 2D NMR. (CO-1)
- i) Discuss briefly the IR signals for the compound $\text{C}_6\text{H}_5 - \text{CH}_2 - \text{O} - \text{CO} - \text{CH}_3$. (CO-2)
- j) Predict the possible number of ^1H NMR signals for the compound $\text{CH}_3 - (\text{CO}) - \text{CH}_2 - \text{CH}_3$. (CO-2)

SECTION – B

(10x5=50M)

UNIT - I

2. a) Explain the effect of solvent on PMR spectrum. (CO-2)
- (Or)
- b) Differentiate between first order and non first order PMR spectrum with examples. (CO-2)

UNIT – II

3. a) Discuss the importance of BBD & SFORD techniques in ^{13}C NMR spectroscopy. (CO-2)
- (Or)
- b) A compound of MF C_4H_{10} in its CMR Spectrum show 17.1(q) 67.4(T). Determine the structure of compound by using CMR data. (CO-2)

UNIT – III

4. a) Explain the following i) Axial halo ketone rule ii) Types of optical rotatory dispersion curves. (CO-1)
- (Or)
- b) Explain the applications of Octant rule. (CO-2)

UNIT – IV

5. a) What information about a compound can be obtained from the 2D INADEQUATE experiment? (CO-2)
- b) Discuss the importance of NOESY technique with suitable example. (CO-2)

UNIT – V

6. a) Deduce the structure of the compound consistent with the following data elemental analysis: $\text{C}=32.14\%$, $\text{H}=5.35\%$ and $\text{Cl}=62.5\%$ UV: No absorption above 210 nm, IR (CCl_4) 2941, 2265 and 1460cm^{-1} PMR δ 2.72(septet, $J=6.7, 1\text{H}$), 1.33(doublet, $J=6.7, 6\text{H}$) (CO-3)
- (Or)
- b) Deduce the structure of the compound consistent with the following data elemental analysis: $\text{C}=32.14\%$, $\text{H}=5.35\%$ and $\text{Cl}=62.5\%$ UV: No absorption above 210 nm IR (CCl_4) 2940, 1265 and 690cm^{-1} and PMR δ 3.5(2H, D), 3.3(1H, m) and 1.25(3H, d) (CO-3)

**M.Sc. DEGREE EXAMINATION
THIRD SEMESTER
Paper-II:: ORGANIC REACTIONS & MECHANISMS**

Time:3hours

Maximum Marks:70

SECTION – A

Answer all the questions. Each question carries 2 marks. (10x2M=20M)

1. a) Discuss oxidations with HIO_4 . (CO-2)
- b) Define oxidation and discuss the various types of oxidations. (CO-1)
- c) Write notes on reduction with diimide. (CO-1)
- d) Give the definition and mechanism of Clemmensen's reduction. (CO-2)
- e) Discuss Dienone phenol rearrangement. (CO-1)
- f) Write an account of Wolff rearrangement. (CO-2)
- g) What are pericyclic reactions? Give the classification. (CO-1)
- h) Write the molecular orbital energy level diagram for 1,3-Butadiene. (CO-2)
- i) Write notes on energy transfer. (CO-1)
- j) Explain Barton reaction. (CO-2)

SECTION – B

(5x10M=50M)

UNIT - I

2. a) Explain oxidations with i) RuO_4 ii) SeO_2 (CO-3)
- (Or)
- b) Explain oxidations with i) KMnO_4 ii) MnO_2 (CO-3)

UNIT – II

3. a) Discuss Birch reduction of aromatic compounds. (CO-2)
- (Or)
- b) Discuss the reductions with LiAlH_4 . (CO-2)

UNIT – III

4. a) Explain the following
 - i) Wagner Meerwein rearrangement ii) Benzil – Benzilic acid rearrangement. (CO-2)
 - (Or)
 - i) Baeyer Villiger rearrangement ii) Cumene hydroperoxide rearrangement. (CO-2)

UNIT - IV

5. a) Apply correlation method to $4n\pi$ electrocyclic reaction for thermal and photochemical conditions. (CO-3)
- (Or)
- b) Apply FMO method to 1,5 sigmatropic shift and write Woodward and Hoffmann rules by PMO method. (CO-3)

UNIT - V

6. a) Discuss Norrish type – I and type – II reactions. (CO-2)
- (Or)
- b) Explain the following i) photochemistry of olefins ii) Di – π – methane rearrangement. (CO-2)

**M.Sc. DEGREE EXAMINATION
THIRD SEMESTER
Paper-III:: ORGANIC SYNTHESIS**

Time:3hours

Maximum Marks:70

SECTION – A

Answer all the questions. Each question carries 2 marks.

(10x2M=20M)

1. a) What are acidic methylene groups? (CO-2)
- b) Explain about carbenes. (CO-1)
- c) Discuss in short about syn elimination. (CO-1)
- d) Elaborate Wittig reaction with an example. (CO-2)
- e) Describe dienophile with an example. (CO-1)
- f) What are Lewis acids? Explain with an example. (CO-2)
- g) Enumerate the significance of Disconnection approach in organic synthesis. (CO-2)
- h) Write a short note on synthon. (CO-1)
- i) Discuss the role of functional group protection & deprotection in organic synthesis. (CO-2)
- j) Explain the importance of regioselective protection. (CO-2)

SECTION – B

(5x10M=50M)

UNIT - I

2. a) Explain enamine and related reactions. (CO-2)
- (Or)
- b) Discuss in detail the synthetic applications of carbenes and carbenoids with examples. (CO-2)

UNIT – II

3. a) Write an account of reductive dimerisation of carbonyl compounds with examples. (CO-2)
- (Or)
- b) Discuss any three methods for the stereoselective synthesis of tri and tetra substituted alkenes. (CO-2)

UNIT – III

4. a) What is Diels Alder reaction? Discuss the mechanism and stereochemistry. (CO-2)
- (Or)
- b) Write note on 1,3 – dipolar cycloaddition reactions. (CO-2)

UNIT - IV

5. a) Discuss the various methods of disconnection of alcohols. (CO-3)
- (Or)
- b) Give an account of disconnections of 1,3 – dicarbonyl compounds. (CO-2)

UNIT – V

6. a) Discuss about the protecting agents to protect the following functional groups
(i) AMINO group (ii) carboxylic acid. (CO-3)
- (Or)
- b) List out the reagents and apply them for the protection and deprotection of hydroxyl and carbonyl groups. (CO-3)

**M.Sc. DEGREE EXAMINATION
THIRD SEMESTER
Paper-IV:: CHEMISTRY OF NATURAL PRODUCTS**

Time: 3 hours

Maximum Marks: 70

SECTION – A

Answer all the questions. Each question carries 2 marks. (10x2M=20M)

1. a) What are alkaloids? Explain. (CO-2)
- b) Discuss the general classification of alkaloids. (CO-1)
- c) Discuss Isoprene rule. (CO-1)
- d) Write the structure of Zingiberine. (CO-2)
- e) Write the synthesis of farnesol. (CO-2)
- f) Discuss the nomenclature of steroids. (CO-1)
- g) Give a short note on classification of flavonoids? (CO-1)
- h) Discuss the isolation of flavonoids and iso-flavonoids. (CO-2)
- i) Discuss the classification of natural pigments. (CO-1)
- j) Discuss the functions of carotenoids in plants. (CO-2)

SECTION – B

(10x5=50M)

UNIT - I

2. a) Outline the synthesis of Morphine. (CO-2)
- (Or)**
- b) Discuss the structure elucidation of Quinine. (CO-3)

UNIT – II

3. a) Explain the structure elucidation of santonin. (CO-2)
- (Or)**
- b) Write notes on structure elucidation of abietic acid. (CO-2)

UNIT – III

4. a) Establish the structure of nucleus and size of the rings A, B, C and D in cholesterol. (CO-3)
- (Or)**
- b) Establish the structure of progesterone and write any one method of synthesis. (CO-3)

UNIT - IV

5. a) Write structure elucidation of kaempferol. (CO-3)
- (Or)**
- b) Write structure elucidation of Quercetin. (CO-3)

UNIT - V

6. a) Discuss the structure elucidation of α -carotene. (CO-3)
- (Or)**
- b) Discuss the structure elucidation of β -carotene. (CO-3)

M.Sc.
DEGREE EXAMINATION
THIRD SEMESTER
POLYMER CHEMISTRY

Time: 3 hours

Maximum Marks: 70

SECTION – A

Answer all the questions. Each question carries 2 marks. (10x2M=20M)

1. a) Discuss about classification of polymers. (CO-1)
- b) Explain one polymerization reaction which involves free radical mechanism. (CO-2)
- c) Give a short account on isolation of polymers. (CO-1)
- d) Describe the purification method of polymers. (CO-1)
- e) What is hydrolysis? Explain with an example. (CO-2)
- f) What is cross – linking reaction? Explain its impact. (CO-2)
- g) List out the types of degradation methods. (CO-1)
- h) Explain ultrasonic waves degradation with an example. (CO-2)
- i) What are elastomers? Explain in brief. (CO-2)
- j) Discuss the method for the synthesis of polystyrene. (CO-2)

SECTION – B

(10x5=50M)

UNIT - I

2. a) Explain in detail about cationic polymerization with suitable examples. (CO-2)
- (Or)**
- b) Give a detailed account on Graft and Block copolymers. (CO-2)

UNIT – II

3. a) Discuss in detail about molecular weight determination. (CO-2)
- (Or)**
- b) Explain elaborately about various processing techniques. (CO-2)

UNIT – III

4. a) Illustrate the following with suitable examples (i) Aminolysis (ii) Cyclisation reactions. (CO-2)
- (Or)**
- b) Write an account on addition & substitution reactions with suitable examples. (CO-2)

UNIT – IV

5. a) Describe the following degradation methods with suitable examples
(i) Thermal degradation (ii) Photodegradation (CO-2)
- b) Discuss the significance of oxidative degradation and hydrolytic degradation. (CO-2)

UNIT – V

6. a) Give an account on the following (i) Polyacrylonitrile (ii) Polyurethanes (CO-2)
- (Or)**
- b) Elaborate the following in detail (i) Epoxy polymers (ii) Silicon polymers (CO-2)

**A.G & S.G SIDDHARTHA DEGREE COLLEGE OF ARTS & SCIENCE,
VUYYURU-521165**

(An Autonomous College in the Jurisdiction of Krishna University)Accredited

at the level 'A' by the NAAC

Sponsors: Siddhartha Academy of General& Technical Education



DEPARTMENT OF COMPUTER SCIENCE

Minutes of the meeting of Board of Studies in Computer Science for PG (M.Sc.)

Date: 17-11-2022



A.G & S.G SIDDHARTHA DEGREE COLLEGE OF ARTS AND SCIENCE::VUYYURU

(An Autonomous College in the Jurisdiction of Krishna University)
Accredited at the level 'A' by the NAAC
Sponsors: Siddhartha Academy of General & Technical Education

DEPARTMENT OF COMPUTER SCIENCE (PG)

Minutes of the meeting of Board of Studies in Computer Science for M.Sc. (Computer Science) programme held on 17-11-2022 at 11:00A.M. for the Department of Computer Science.

Members Present		
Name of the Member	Role	Signature
Smt. T.Keerthi, I/C HOD, Dept. of Computer Science, A.G & S.G Siddhartha Degree College of Arts & Science, Vuyyuru-521165. Mobile: 9959558485 E-Mail: keerthitineni16@gmail.com	Chairman	
Dr. K.Madhavi, Associate Professor, Dept of Computer Science, JNTUA. College of Engineering, Anantapur. Mobile: 9440206501 E-Mail: kasamadhavi@yahoo.com	University Nominee, Krishna University	
Dr.R.Satya Prasad, Professor, Department of Computer Science, Acharya Nagarjuna University, Nagarjuna Nagar-522508. Mobile: 9848487478 E-Mail: profrsp@gmail.com	Subject Expert	
Dr.T.S.Ravi Kiran, H.O.D & Assistant Professor, Dept of Computer Science, P.B. Siddhartha Degree College of Arts & Science-Vijayawada -520002. Mobile: 9441176980 E-Mail: kirantsr1@gmail.com	Special Invitee	
Sri.U.Sairam, C.E.O, Codegnan I.T Solutions OPC PVT LTD., Vijayawada 520002 Mobile: 9959555952 E-Mail: uppugundlasairam@gmail.com	Industrialist	
Ms. P.Srujana, Software Developer, TonmetriInfoSolutions, Vijayawada. Mobile: 9032671688 E-Mail: srujanapaladugu26@gmail.com	Alumni Representative	
Smt. V. Muni, Assistant Professor, A.G & S.G Siddhartha Degree College of Arts & Science. Mobile: 8099205522 E-Mail: muni.j2ee@gmail.com	Member	
Sri.B.MadhuSudhana Rao, Assistant Professor, A.G & S.G Siddhartha Degree College of Arts & Science. Mobile: 7842664766 E-Mail: ms.madhu27@gmail.com	Member	

PG

AGENDA

- To discuss and approve the *Structure, Syllabi and Model Question Papers* of *First Semester* of M.Sc.(Computer Science) for the batch of students admitted from the academic year 2022-2023 and onwards.
- To discuss and approve the *Structure, Syllabi and Model Question Papers* of *Third Semester* of M.Sc.(Computer Science) for the batch of students admitted from the academic year 2022-2023 and onwards.

RESOLUTIONS

- **Resolved and recommended to continue the same syllabus, model papers without changes in the First Semester for the following courses:**
 - Formal languages & Automata Theory (22CS1T3)
 - Data Base Management System Lab (22CS1L2)
- **Resolved and recommended to introduce new syllabus, model papers in the First Semester for the following courses:**
 - Programming & problem Solving using Python (22CS1T1)
 - Data Base Management System (22CS1T2)
 - Operating System (22CS1T4)
 - Python Lab (22CS1L1)
- **To discuss and approve the *Structure, Syllabi and Model Question Papers* of *Open Electives* “*Personality Development Through Life Enlighten Skills*” for *First Semester***
- **Resolved and recommended to continue the same syllabus, model papers without changes in the Third Semester for the following courses:**
 - Design & Analysis Of Algorithm (22CS3E1)
 - Internet Of Things (22CS3E5)
 - Cryptography & Network Security (22CS3E3)
 - Data Mining Techniques (22CS3E2)
- **Resolved and recommended to introduce new syllabus, model papers in the Third Semester for the following courses:**
 - Web Technologies Lab (20CS3L1)
 - Cryptography & Network Security Lab (22CS3L2)

A.G & S.G Siddhartha Degree College of Arts & Science, Vuyyuru – 521165.
(An Autonomous College in the jurisdiction of Krishna University)
M.Sc., (ComputerScience)Programme – I Semester

Course	Programming and Problem Solving Using Python		
Course Code	22CS1T1	Course Delivery Method	Class Room /
Credits	4	CIA Marks	30
No. of Lecture Hours / Week	4	Semester End Exam	70
Total Number of Lecture Hours	60	Total Marks	100
Year of Introduction:2020-21	Year of Offering:2021-22	Year of Revision:2021-22	Percentage of Revision: 0%

Course Description and Purpose: Python Programming is a course that illustrates basic concepts of Python programming, Decision Control Statements, Functions and Modules, Python Strings Revisited, Data Structures, Classes and Objects, Inheritance, Operator Overloading, Pandas, Error and Exception Handling, File Handling, Numpy, Matplotlib.

Course Objectives:

This course will help enable the students to understand, learn and develop a various Decision Control Statements, Functions & Modules, Strings, Data Structures, Classes and Objects, Inheritance, Operator Overloading, Pandas, Error and Exception Handling, Handling Files, Databases.

Specific objectives include:

- To understand basics of *Python Programming*.
- To gain knowledge on *Decision Control Statements* and *Functions & Modules and Python Strings and DataStructures*.
- To gain knowledge on *Classes & Objects, Ingeritance*.
- To apply *Operator Overloading, Error and Exception Handling* and Pandas.
- To gain knowledge on File Handling, Database Connection, basics of Numpy and matplotlib.

Course Learning Outcomes:

Upon successful completion of the course, the student will be able to:

- Understand basics of Python Programming.
- Gain knowledge on *Decision Control Statements* and *Functions & Modules and Python Strings and DataStructures*.
- Gain knowledge on *Classes & Objects & Inheritance*.
- Apply Operator Overloading, Error and Exception Handling and Pandas.
- Gain Knowledge on File Handling, Database Connection and basics of Numpy and matplotlib

Unit	Learning Units	Lecture Hours
I	<p>Basics of Python Programming: Features of Python, History of Python, The Future of Python, Writing and Executing First Python Program, Literal Constants, Variables and Identifiers, Data Types, Input Operation, Comments, Reserved Words, Indentation, Operators and Expressions, Expressions in Python, Operations on Strings, Other Data Types, Type Conversion.</p> <p>Decision Control Statements: Conditional Branching Statements, Basic Loop Structures, Nested Loops, The Break Statement, The Continue Statement, The Pass Statement, The Else Statement used with Loops.</p>	15
II	<p>Functions and Modules: Function Definition, Function Call, Variable Scope and Lifetime, The Return Statement, More on Defining Functions, Recursive Functions, Modules, Packages in Python, Standard Library Modules.</p> <p>Python Strings Revisited: Concatenating, Appending and Multiplying Strings, String Formatting Operator, Built in String Methods and Functions, Comparing Strings, Regular Expressions.</p> <p>Data Structures: Sequence, Lists, Functional Programming, Tuple, Sets, Dictionaries.</p>	15
III	<p>Classes and Objects: Classes and Objects, Class Method and self Argument, Class Variables and Object Variables, Public and Private Data Members, Private Methods, Calling a Class Method from Another Class Method, Built in Class Attributes, Class Methods, Static Methods.</p> <p>Inheritance: Inheriting Classes in Python, Types of Inheritance, Abstract Classes and Interfaces.</p>	15
IV	<p>Operator Overloading: Concept of Operator Overloading, Advantage of Operator Overloading, Implementing Operator Overloading.</p> <p>Pandas: Introduction, Getting Started, Series, Data Frame, Read CSV, Read JSON -Analyzing Data Frames, Cleaning Data, Cleaning Empty Cell, Cleaning Wrong Format, Cleaning Wrong Data, Removing Duplicates, Correlations, Plotting.</p> <p>Error and Exception Handling: Introduction to Errors and Exceptions, Handling Exceptions, Raising Exceptions, Built in and User defined Exceptions.</p>	15
V	<p>File Handling: File Path, Types of Files, Opening and Closing Files, Reading and Writing Files.</p> <p>Databases: Database Table Creation, Select Operation, Insert Operation, Delete Operation, Update Operation, Drop Table.</p> <p>Numpy: Basic Functions of Numpy.</p> <p>Matplotlib: Basic Functions of Matplotlib.</p>	15

Prescribed Text Book

	Author	Title	Publisher
1	Reema Thareja	Python Programming Using Problem Solving Approach	Oxford University Press, June 2017.

Reference Text Book

1	Vamsi Kurama	Python Programming, A Modern Approach	Pearson, 2017
2	Wesley Chun	Core Python Programming	Prentice Hall, December 2000

e-resources: <https://www.w3schools.com/python/pandas/>

A.G & S.G Siddhartha Degree College of Arts & Science, Vuyyuru – 521165.

(An Autonomous College in the jurisdiction of Krishna University)

M.Sc.(Computer Science), First Semester

Course Name: PROBLEM SOLVING USING PYTHON PROGRAMMING

Course Code: 22CSIT1

(w.e.f admitted batch 2022-23)

Time: 3 Hours

Max Marks: 70

SECTION-A

Answer ALL questions

(5×4 = 20 Marks)

1. a) Explain *Future of Python* (BTL2)
(OR)
b) Explain different *Data Types* in *Python* (BTL2)
2. a) What is *Recursive Function*? Explain with *example*.(BTL1)
(OR)
b) List out and explain any 4 *Built in String Method*?(BTL1)
3. a) What is the *Differences between Class Variable and Object Variable*?(BTL1)
(OR)
b) List out *Built in Class Attributes*? (BTL1)
4. a) Explain *Advantages of Operator Overloading*? (BTL2)
(OR)
b) Explain *Exception Hierarchy*? (BTL2)
5. a) Explain *Types of Plots in Matplotlib*? (BTL2)
(OR)
b) Explain different ways of *creating Arrays* using *Numpy*. (BTL2)

SECTION-B

Answer Five Questions Choosing One Question from Each Unit.

All Questions Carry Equal Marks.

(5×10 = 50 Marks)

UNIT – I

6. A) Explain the *features of Python Programming Language*.(BTL2)
(OR)
B) Explain *Different Loops* in *Python* with *example*. (BTL2)

UNIT – II

7. A) Apply *Modules Concept* in *Python* with *examples*. (BTL3)
(OR)
B) Build the *List Data Structure and their built in functions* with *examples*. (BTL3)

UNIT – III

8. A) What are *Classes and Objects*? Write a program in *Python* to illustrate an *instancevariable*. (BTL1)
(OR)
B) What is *Inheritance*? Explain *different types of Inheritance*. (BTL1)

UNIT – IV

9. A) Explain how to *Implement Operator Overloading* in *Python*. (BTL2)
(OR)
B) Explain *process of Analyzing Data Frames*. (BTL2)

UNIT – V

10. A) Explain *process of Writing and Reading data from file* with *example*. (BTL5)
(OR)
B) Explain *process of Update Data into Database* with *relevant examples*. (BTL5)

A.G & S.G Siddhartha Degree College of Arts & Science, Vuyyuru – 521165.
(An Autonomous College in the jurisdiction of Krishna University)
M.Sc., (Computer Science) Programme – I Semester

Course	Programming and Problem Solving Using Python Lab		
Course Code	22CS1L1	Course Delivery Method	Class Room /
Credits	4	CIA Marks	30
No. of Lecture Hours / Week	4	Semester End Exam	70
Total Number of Lecture Hours	60	Total Marks	100
Year of Introduction:2020-21	Year of Offering:2021-22	Year of Revision:2021-22	Percentage of Revision: 0%

Course Description and Purpose:

Python Programming is a course that illustrates Basic Concepts of Python programming, Decision Control Statements, Functions and Modules, Python Strings Revisited, Data Structures, Classes and Objects, Inheritance, Operator Overloading, Pandas, Error and Exception Handling, File Handling, Numpy, Matplotlib.

Course Objectives:

This course will help enable the students to understand, learn and develop a various Decision Control Statements, Functions & Modules, Strings, Data Structures, Classes and Objects, Inheritance, Operator Overloading, Pandas, Error and Exception Handling, Handling Files, Databases.

Specific objectives include:

- To understand *Basics of Python Programming, Decision Control Statements.*
- To know the concepts of *Data Structures, Functions and Modules.*
- To know the concepts of *Classes and Objects, Object Oriented Programming.*
- To apply *Error and Exception Handling.*
- To implement *Database Access and File Handling.*

Course Learning Outcomes:

Upon successful completion of the course, the student will be able to:

- Understand *Basics of Python Programming, Decision Control Statements.*
- Know the concepts of *Data Structures, Functions and Modules.*
- Know the concepts of *Classes and Objects, Object Oriented Programming.*
- Apply *Error and Exception Handling.*
- Implement *Database Access and File Handling.*

LAB LIST

1. Write a program to find total for given number of tens, number of fives, number of twos and number of ones.
2. Write a program to enter a number and display its hex and octal equivalent and its square root.
3. Write a program to read and print values of variables of different data types.
4. Write a program to calculate the distance between two points.
5. Write a program to calculate area of triangle using Heron's formula.(Hint: Heron's formula is given as:

$area = \sqrt{S(S-a)(S-b)(S-c)}$.

6. Write a program to calculate the distance between two points.
7. Write a program to perform addition, subtraction, multiplication, division, integer division.
8. Write a program to find the greatest number from three numbers.
9. Write a program to calculate tax given the following conditions: If income is less than 1,50,000 then no tax
If taxable income is Rs.1,50,001, Rs.300,000 then charge 10% tax
If taxable income is Rs.3,00,001, Rs.500,000 then charge 20% tax
If taxable income is above Rs.5,00,001 then charge 30% tax
10. Write a program to calculate roots of quadratic equation.
11. Write a program to enter the marks of a student in four subjects. Then calculate the total and aggregate, and display the grade obtained by the student. If the student scores an aggregate greater than 75%, then the grade is Distinction. If aggregate is $60 \geq$ and < 75 , then grade is First Division. If the aggregate is $50 \geq$ and < 60 , then the grade is Second Division. If aggregate is $40 \geq$ and < 50 , then the grade is Third Division. Else the grade is Fail.
12. Write a program to read the numbers until -1 is encountered. Find the average of positive numbers and negative numbers entered by the user.
13. Write a program to find whether the given number is an *Armstrong Number* or *not*.
14. Write a program to enter a Decimal Number. Calculate and display its Binary Equivalent.
15. Write a program to demonstrate List Operations.
 - Access List Items
 - Change Item Value
 - Appended Items
 - Remove Specified Item
 - Loop Through a List
 - List Comprehension
 - Sort List Alphanumerically
 - Copy a List
 - Join Two Lists
 - List Methods
16. Write a program to demonstrate Tuple Operations.
 - Access Tuple Items
 - Negative Indexing
 - Range of Indexes
 - Range of Negative Indexes
 - Check if Item Exists
 - Update Tuples
 - Add Items
 - Remove Items
 - Unpacking a Tuple
 - Using Asterisk*
 - Loop Through a Tuple
 - Loop Through the Index Numbers

- Using a While Loop:
 - Python, Join Tuples
 - Join Two Tuples
 - Multiply Tuples
17. Write a program to demonstrate Set Operations.
 - Access Set Items
 - Add Set Items
 - Loop Sets
 - Join Two Sets
 - Keep ONLY the Duplicates
 - Keep All, But NOT the Duplicates

 18. Write a program to demonstrate Dictionary Operations.
 - Ordered or Unordered?
 - Changeable
 - Duplicates Not Allowed
 - Accessing Items
 - Change Values
 - Update Dictionary
 - Adding Items
 - Remove Dictionary Items
 - Loop Through a Dictionary
 - Copy a Dictionary
 - Nested Dictionaries

 19. Write a program to enter a number and then calculate the *Sum of its Digits*.
 20. Write a program to print the *Reverse Number*.
 21. Write a program to calculate GCD of two numbers.
 22. Write a program that prompts users to enter numbers. The process will repeat until user enters -1. Finally, the program prints the count of prime and composite numbers entered.
 23. Write a program
 - a) To calculate the factorial of number recursively.
 - b) To calculate GCD using the recursive functions.
 24. Write a program
 - c) To calculate $\exp(x, y)$ using recursive functions
 - d) To print the Fibonacci Series using Recursion.
 25. Write a program make a *Simple Calculator*.
 26. Write a program that defines a function large in a module which will be used to find large of two values and called from a code in another module.
 27. Write a program that demonstrate the use of method `__init__`.
 28. Write a program to illustrate the modification of instance variable.
 29. Write a program for modifying a mutable type attribute.
 30. Write a program to demonstrate the use of inheritance.
 31. Write a Program to demonstrate Polymorphism.
 32. Write a program to demonstrate Polymorphism using Function Overloading.
 33. Write Program to demonstrate Method Overriding with arguments.

34. Write a python program to demonstrate multilevel inheritance.
35. Write a program to demonstrate Multipath Inheritance (or) Hybrid Inheritance.
36. Write a program to demonstrate Multi Level Inheritance (A person is teacher & having designation HOD)
37. Write a program to demonstrate *Multi-Path Inheritance*.
38. Write a program to illustrate the concept of Abstract Class.
39. Write a program to overload the + operator on a complex object.
40. Write a program to handle Divide by Zero Exception.
41. Write a program to handle Multiple Errors with One Except statement.
42. Write a program with Multiple Except Blocks.
43. Write a program to demonstrate else statement in exception handling.
44. Write a python program to illustrate the *try...catch...finally* in exception handling.
45. Write a program to demonstrate Regular Expression Functions.
 - findall()
 - Search
 - Split
 - sub()
46. Write a program Demonstrate Regular Expression Meta Characters.
 - Python program to match string using metacharacter []
 - Program to find digits in character using metacharacter \
 - Program for sequence that starts with "he", followed by two (any) characters using metacharacter ..
 - Program to check if the string starts with 'hello' using metacharacter ^
 - Program to check the string ends with 'world' using metacharacter \$
 - Program to check the string contains "ai" followed by 0 or more "x" characters
 - Program to check the string contains "ai" followed by 1 or more "x" characters
 - Program to check if the string contains "a" followed by exactly two "l" characters
 - Program to check if the string contains either "falls" or "stays" using meta character |
47. Write a program to demonstrate Regular Expression Sequences.
 - Program to check if the string starts with "The"
 - Program to check if "ain" is present at the begining of a word
 - Program to check if "ain" is present at the end of a word.
 - Program to check if "ain" is present, but NOT at the begining of a word.
 - Program to check if "ain" is present, but NOT at the end of a word.
 - Program to Check if the string contains any digits (numbers from 0-9).
 - Program to return a match at every no-digit character.

- Program to return a match at every white-space character.
- Program to return a match at every NON white-space character.
- Program to return a match at every word character (characters from a to Z, digits from 0-9, and the underscore _ character)
- Program to return a match at every NON word character (characters NOT between a and Z. Like "!", "?" white-space etc.)
- Program to check if the string ends with "Spain".

48. Write a program to demonstrate Regular Expression Sets.

- Program Check if the string has any a, r, or n characters.
- Program to Check if the string has any characters between a and n.
- Program to Check if the string has other characters than a, r, or n.
- Program to check if the string has any 0, 1, 2, or 3 digits.
- Program to check if a string has any digits.
- Program to check if the string has any two-digit numbers, from 00 to 59.
- Program to Check if the string has any characters from a to z lower case, and A to Z upper case.
- Program to check if the string has any + characters.

49. Write a program to

- Create EMP table with attributes ENO, ENAME and ESAL into PBS database.
- Insert rows into EMP table of PBS database.
- Update rows of EMP table of PBS database.
- Delete rows from EMP table of PBS database.
- Drop EMP table of PBS database.

50. Write a program to open the file and count the number of times a character appears in the file.

A.G & S.G Siddhartha Degree College of Arts & Science, Vuyyuru – 521165.
(An Autonomous College in the jurisdiction of Krishna University)
M.Sc., (Computer Science)Programme – I Semester

Course	Database Management Systems		
Course Code	22CS1T2	Course Delivery Method	Class Room / Blended Mode
Credits	4	CIA Marks	30
No. of Lecture Hours / Week	4	Semester End Exam	70
Total Number of Lecture Hours	60	Total Marks	100
Year of Introduction:2020-21	Year of Offering:2021-22	Year of Revision:2021-22	Percentage of Revision: 0%

Course Description and Purpose:

Database Management Systems is a course that illustrates basic concepts of *Databases and Database Users, Database System Architecture, ER & EER Relationship Modeling, Structured Query Language, Relational Algebra and Relational Calculus, Functional Dependencies and Normalization for Relational Databases, Transaction Processing Concepts, Concurrency Control Techniques and Emerging Database Technologies and Applications.*

Course Objectives:

This course will help enable the students to understand, learn and develop a various *Relational Data Models, Querying, ER & EER Modeling, Relational Algebra & Calculus, Functional Dependencies and Normalization, Transaction Processing, Concurrency Control and Emerging Database Technologies and Applications.*

Specific objectives include:

- To understand basic concepts of *Database and Database Users, Database Architecture.*
- To understand *ER, EER Modelling and Relational Algebra and Relational Calculus.*
- To learn the basics of *Functional Dependencies and Normalization* for Relational Databases.
- To learn *Transaction Processing and Concurrency Control Techniques.*
- To understand the *Structured Query Language and Emerging Database Technologies and Applications:*

Course Learning Outcomes:

Upon successful completion of the course, the student will be able to:

- Understand basic concepts of *Database and Database Users, Database Architecture.*
- Understand *ER, EER Modeling and Relational Algebra and Relational Calculus.*
- Learn the basics of *Functional Dependencies and Normalization* for Relational Databases.
- Learn *Transaction Processing and Concurrency Control Techniques.*
- Understand the *Structured Query Language and Emerging Database Technologies and Applications.*

Unit	Title	Lecture Hours
I	<p>Database and Database Users: Introduction, Characteristics of the Database Approach, Actors on the Scene, Workers behind the Scene, Advantages of the using the DBMS Approach.</p> <p>Database System Concepts and Architecture: Data Models, Schemas and Instances, Three Schema Architecture and Data Independence, Database Languages and Interfaces, Centralized and Client/Server Architecture for DBMS, Classification of Database Management Systems.</p>	15
II	<p>Data Modeling Using the ER Model: Conceptual Data Models, Entity Types, Entity Sets, Attributes and Keys, Relationship Types, Relationship Sets, Roles and Structural Constraints, Weak Entity Types, Relationship Types of Degree Higher than Two, Refining the ER Design for the COMPANY Database.</p> <p>The Enhanced Entity-Relationship Model: Sub Classes, Super Classes and Inheritance, Specialization and Generalization, Constraints and Characteristics of Specialization and Generalization.</p> <p>The Relational Algebra and Relational Calculus: Unary Relational Operations: SELECT and PROJECT, Relational Algebra Operations from Set Theory, Binary Relational Operations: JOIN and DIVISION, Additional Relational Operations, Examples, The Tuple Calculus and Domain Calculus</p>	15
III	<p>Functional Dependencies and Normalization for Relational Databases: Informal Design Guidelines for Relation Schemas, Functional Dependencies, Normal Forms Based in Primary Keys, General Definitions of Second and Third Normal Forms, Boyce-Codd Normal Form, Multivalued Dependencies and Fourth Normal Form, Join Dependencies and Fifth Normal Form, Inclusion Dependencies.</p>	15
IV	<p>Introduction to Transaction Processing Concepts and Theory: Introduction to Transaction Processing, Transaction and System Concepts, Desirable Properties of Transactions, Characterizing Schedules Based on Recoverability, Characterizing Schedules based on Serializability.</p> <p>Concurrency Control Techniques: Two Phase Locking Techniques for Concurrency Control, Concurrency Control Based on Timestamp Ordering, Multiversion Concurrency control techniques, Validation Concurrency Control Techniques.</p>	15
V	<p>SQL-99: Schema Definition, Constraints, Queries and Views: SQL Data Definitions and Data Types, Specifying Constraints in SQL, Schema Change Statements on SQL, Basic Queries in SQL, More Complex SQL Queries, INSERT, DELETE and UPDATE statements in SQL, Triggers and Views.</p> <p>Emerging Database Technologies and Applications: Mobile Databases, Multimedia Databases, Geographic Information Systems.</p>	15

Prescribed Text Book

	Author	Title	Publisher
1	Ramez Elmasri, Shamkant B. Navathe	Fundamentals of Database Systems	Pearson Education, Seventh Edition, 2017
2	C.J.Date, A.Kannan, S.Swamynathan	An Introduction to Database Systems	VII Edition, Pearson Education, 2006.
3	Peter Rob, Carlos Coronel	Database Systems-Design, Implementation and Management	Eight Edition, Thomson, 2008

A.G & S.G Siddhartha Degree College of Arts & Science, Vuyyuru – 521165.

(An Autonomous College in the jurisdiction of Krishna University)

M.Sc.(Computer Science), First Semester

Course Name: Database Management Systems Course Code: 22CS1T2

(w.e.f admitted batch 2022-23) Time: 3 Hours

Max Marks: 70

SECTION-A

Answer ALL questions. All Questions Carry Equal Marks. (5×4 = 20 Marks)

1 (a) Name the advantages of the DBMS. (BTL1)

(or)
(b) What is Data Independence? Explain the difference between *Physical Data Independence* and *Logical Data Independence*. (BTL1)

2 (a) What is *Generalization*? Explain it diagram. (BTL1)
(or)
(b) What are various symbols used in *ER Modeling*. (BTL1)

3 (a) Explain *First Normal Form*. (BTL2)
(or)
(b) Explain *Dependency Preservation* with example. (BTL2)

4 (a) Explain *Properties of Transaction*. (BTL2)
(or)
(b) Explain *Shared* and *Exclusive* Locks. (BTL2)

5 (a) Explain *DML Commands* with example. (BTL5)
(or)
(b) Explain *Mobile Databases*. (BTL5)

SECTION-B

Answer ALL questions. All Questions Carry Equal Marks. (5×10 = 50 Marks)

6 (a) Explain various *Data Models* of Database Management Systems. (BTL2)
(or)
(b) Explain *Three Schema Architecture* of DBMS with neat diagram. (BTL2)

7 (a) Demonstrate *Select* and *Project* operations of *Relational Algebra*. (BTL2)
(or)
(b) Explain *ER Design* for the *Company Database* with all constraints. (BTL2)

8 (a) Explain *BCNF* with example. (BTL5)
(or)
(b) Explain *Fifth Normal Form* with example. (BTL5)

9 (a) Identify whether the transactions T1 & T2 ensure *serializability*. (BTL3)

T1	T2
read_item (X) ;	read_item(X);
X:=X – N;	
	X:=X +

(or)

(b) Develop a technique for *Concurrency Control Based on Timestamp Ordering*. (BTL3)

10 (a) Analyze *Multimedia Databases* in detail. (BTL4)
(or)
(b) Distinguish various *Constraints* of SQL. (BTL4)

A.G & S.G Siddhartha Degree College of Arts & Science, Vuyyuru – 521165.

(An Autonomous College in the jurisdiction of Krishna University)

M.Sc., (Computer Science) Programme – I Semester

Course	Database Management Systems Lab		
Course Code	22CS1L2	Course Delivery Method	Class Room / Blended
Credits	4	CIA Marks	30
No. of Lecture Hours / Week	4	Semester End Exam Marks	70
Total Number of Lecture Hours	60	Total Marks	100
Year of Introduction:2020-21	Year of Offering:2021-22	Year of Revision:2021-22	Percentage of Revision: 0%

Course Description and Purpose:

Database Management Systems Laboratory is a course that illustrates *DDL and DML Commands, Basic SQL Queries, Complex SQL Queries, Joins, Integrity Constraints, Views, Cursors, Triggers, and Functions and Procedures using PL/SQL.*

Course Objectives:

This course will help enable the students to understand, learn and practice develop a various *Relational Data Models, Querying, DDL and DML Commands, Basic SQL Queries, Complex SQL Queries, Joins, Integrity Constraints, Views, Cursors, Triggers, and Functions and Procedures using PL/SQL.*

Specific objectives include:

1. Database creation using DDL Commands.
2. Retrieval of Data from database using DML Commands for a given situation.
3. Use SQL commands familiarizing with a Query Language.
4. Using Nested Queries, Joins, Integrity Constraints and Views in database.
5. Demonstrating Triggers, Functions and Procedures using PL/SQL.

Course Learning Outcomes:

Upon successful completion of the course, the student will be able to:

1. Create database using *DDL Commands*.
2. Retrieve data from database using *DML Commands* for a given situation.
3. Familiarize with a Query Language through basic SQL Queries.
4. Experiment *Nested Queries, Joins, Integrity Constraints* and *Views* in database.
5. Demonstrate *Triggers, Functions* and *Procedures* using PL/SQL.

CYCLE-I

Aim: Marketing Company wishes to computerize their operations by using following tables.

Table Name: Client- Master			
Column Name	Data Type	Size	Attribute
CLIENT_ NO	Varchar2	6	Primary key and first letter must start with
NAME	Varchar2	20	Not null
ADDRESS 1	Varchar2	30	
ADDRESS S	Varchar2	30	
CITY	Varchar2	15	
PINCODE	Varchar2	8	
STATE	Varchar2	15	
AL_DUE	Number	10,2	

Table Name: Product_Master			
Column Name	Data Type	Size	Attribute
PRODUCT_NO	Varchar2	6	Primary key and first letter must start with
DESCRIPTION	Varchar2	15	Not null
PROFIT_PERCENT	Number	4,2	Not null
UNIT_MEASURE	Varchar2	10	
QTY_ON_HAND	Number	8	
REORDER_LVL	Number	8	
SELL_PRICE	Number	8, 2	Not null, cannot be 0
COST_PRICE	Number	8,2	Not null, cannot be 0

Table Name: Salesman_Master			
Column Name	Data Type	Size	Attribute
SALESMAN_NO	Varchar2	6	Primary key and first letter must start with 'S'
SALESMAN_NAME	Varchar2	20	Not null
ADDRESS1	Varchar2	30	
ADDRESS2	Varchar2	30	
CITY	Varchar2	20	
PINCODE	Number	8	
STATE	Varchar2	20	

SAL_AMT	Number	8,2	Not null, cannot be 0
TGT_TO_GET	Number	6,2	Not null, cannot be 0
YTD_SALES	Number	6,2	Not null
REMARKS	Varchar2	20	

Table Name: Sales_Order			
Column Name	Data Type	Size	Attribute
ORDER_NO	Varchar2	6	Primary key and first letter must start with 'S'
CLIENT_NO	Varchar2	6	Foreign Key
ORDER_DATE	Date		
DELY_ADDRESS	Varchar2	25	
SALESMAN_NO	Varchar2	6	Foreign Key
DELY_TYPE	Char	1	Delivery: part(p)/ full(f) and default 'F'
BILL_YN	Char	1	
DELY_DATE	Date		Can't be less than order date
ORDER_STATUS	Varchar2	10	Values ("In Process", "Fulfilled",

Table Name: Sales_Order_Details			
Column Name	Data Type	Size	Attribute
ORDER_NO	Varchar2	6	Primary key references SALES_ORDER table
PRODUCT_NO	Varchar2	6	Foreign Key references SALES_ORDER table
QTY_ORDERED	Number	8	
QTY_DISP	Number	8	
PRODUCT_RATE	Number	10, 2	Foreign Key

ve the following queries by using above tables

1. Retrieve the list of names, city and the state of all the clients.
2. List all the clients who are located in 'Mumbai' or 'Bangalore'.
3. List the various products available from the product_master table.
4. Find the names of sales man who have a salary equal to Rs.3000.
5. List the names of all clients having 'a' as the second letter in their names.
6. List all clients whose Bal due is greater than value 1000.
7. List the clients who stay in a city whose first letter is 'M'.
8. List all information from sales-order table for orders placed in the month of July.
9. List the products whose selling price is greater than 1000 and less than or equal to 3000.
10. Find the products whose selling price is greater than 1000 and also find the new selling price as original selling price 0.50.
11. Find the products in the sorted order of their description.
12. Find the products with description as '540HDD' and 'Pen drive'.
13. Count the total number of orders.
14. Print the description and total qty sold for each product.
15. Calculate the average qty sold for each client that has a maximum order value of 15,000.
16. Find all the products whose quantity on hand is less than reorder level.
17. List the order number and day on which clients placed their order.
18. Find out the products and their quantities that will have to deliver in the current month.
19. Find the names of clients who have placed orders worth of 10000 or more.
20. Find the client names who have placed orders before the month of June, 2018.

CYCLE-II

Aim: A manufacturing company deals with various parts and various suppliers supply these parts. It consists of three tables to record its entire information. Those are as follows.

Supplier (Supplier_No, Sname, City, status) Part (Part_no, pname, color, weight, city, cost) Shipment (supplier_No, Part_no, city)

JX (project_no, project_name, city)

SPJX (Supplier_no, part_no, project_no, city)

Solve the following queries by using above tables.

1. Get supplier numbers and status for suppliers in Chennai with status > 20.
2. Get project names for projects supplied by supplier S.
3. Get colors of parts supplied by supplier S1.
4. Get part numbers for parts supplied to any project in Mumbai.
5. Find the id's of suppliers who supply a red or pink parts.
6. Find the pnames of parts supplied by London supplier and by no one else.
7. Get the names of the parts supplied by the supplier 'Mart' and 'Miller'.
8. Get supplier names for suppliers who do not supply part P2.
9. Get all pairs of supplier numbers such that the suppliers concerned are "colocated".
10. Get suppliers names for the suppliers who supply at least one red part.

CYCLE-III

Aim: An enterprise wishes to maintain a database to automate its operations. Enterprise divided into a certain departments and each department consists of employees. The following two tables describes the automation schemas. Emp (Empno, Ename, Job, Mgr, Hiredate, Sal, Comm, Deptno) Dept (Deptno, Dname, Loc)

Solve the following queries by using above tables.

1. List the details of employees who have joined before the end of September '81.
2. List the name of the employee and designation of the employee, who does not report to anybody.
3. List the name, salary and PF amount of all the employees (PF is calculated as 10% of salary)

4. List the names of employees who are more than 2 years old in the organization.
5. Determine the number of employees, who are taking commission.
6. Update the employee salary by 20% , whose experience is greater than 12 years.
7. Determine the department does not contain any employees.
8. Create a view, which contains employee name and their manager names working in sales department.
9. Determine the employees, whose total salary is like the minimum salary of any department.
10. List the department numbers and number of employees in each department.
11. Determine the employees, whose total salary is like the minimum salary of any department.
12. List average salary for all departments employing more than five people.
13. Determine the names of employees, who take highest salary in their departments.
14. Determine the names of employees, who earn more than their managers.
15. Display ename, dname, even if no employee belongs to that department (use outer join).

CYCLE-IV

An Airline system would like to keep track their information by using the following relations.

FLIGHTS(fl_no: integer, from: string, to: string, distance: integer, price: integer)
 AIRCRAFT(aid: integer, aname: string, cruising_range: integer)
 CERTIFIED(eid integer, aid: integer)
 Employees(eid: integer, ename: string, salary: real)

Note that the employees relation describes pilots and other kinds of employees as well; every pilot is certified for aircraft and only pilots are certified to fly. Resolve the following queries.

- a. Find the names of pilots whose salary is less than the price of the cheapest route from Newyork to Chicago.
- b. For each pilot who is certified for more than 2 aircraft, find the eid's and the maximum cruising range of the aircraft that hear she certified for.
- c. For all aircraft with cruising range over 1,500 miles, find the name of the aircraft and the average salary of all pilots certified for this aircraft.
- d. Find the aid's of all aircraft than can be used from chicaga to LosAngels.
- e. Find the name of the pilots certified from some Boeing aircraft.
- f. Print the enames of pilots who can operate planes with cruising range greater than 3,500 miles, but are not certified by Boeing aircraft.
- g. Find the eid's of employees who are certified for exactly 2 aircrafts.
- h. Find the total amount paid to employees as salaries.
- i. Find the aid's of all than can be used on non-stop flights from Chennai to Dubai.
- j. Find the eid's of employee who make second highest salary.

PL/SQL PROGRAMS

1. Write a PL/SQL program to check the given number is strong or not.
2. Write a PL/SQL program to check the given string is palindrome or not.
3. Write a PL/SQL program to swap two numbers without using third variable.
4. Writ a PL/SQL program to generate multiplication tables for 2, 4, 6.
5. Write a PL/SQL program to check the given number is Armstrong or not.
6. Write a PL/SQL code to find the factorial of any number.
7. Write a PL/SQL program to display sum of even numbers and sum of odd numbers in the given range.
8. Write a PL/SQL program to check the given number is palindrome or not.
9. The HRD manager has decide to raise the employee salary by 15% write a PL/SQL block to accept the employee number and update the salary of that employee. Display appropriate message based on the existence of the record in Emp table.
10. Write a PL/SQL program to display to 10 rows in Emp table based on their job and salary.

11. Write a PL/SQL program to raise the employee salary by 10% for department number 30 people and also maintain theraised details in the raise table.
12. Write a procedure to update the salary of Employee, who are not getting commission by 10%.
13. Write a PL/SQL procedure to prepare an electricity bill by using following table.

Table used: Elect		
Name	Null?	Type
MNNO	NOT NULL	NUMBER(3)
CNAME		VARCHAR2(20)
CUR_READ		NUMBER(5)
PREV_READ		NUMBER(5)
NO_UNITS		NUMBER(5)
AMOUNT		NUMBER(8,2)
SER_TAX		NUMBER(8,2)
NET_AMT		NUMBER(9,2)

14. Write a PL/SQL program to prepare an telephone bill by using following table and print the monthly bills for eachcustomer.

Table used: Phone		
Name	Null?	Type
TEL_NO	NOT NULL	NUMBER(6)
CNAME		VARCHAR2(20)
CITY		VARCHAR2(10)
PR_READ		NUMBER(5)
CUR_READ		NUMBER(5)
NET_AMT		NUMBER(5)
TOT-AMT		NUMBER(8,2)

15. Write a PL/SQL program to raise the employee salary by 10 %, who are completed their 25 years of service and store the details at appropriate tables (Define the Retair_ Emp_Table).
16. Write a PL/SQL program to evaluate the grade of a student with following conditions: For pass: all marks > 40 For I class: Total % > 59 For II Class: Total % etween >40 and < 60 For III class: total % = 40 And also maintain the details in abstract table.

1. Table Std		
Name	Null?	Type
NO	NOT NULL	NUMBER
NAME		VARCHAR2(10)
INTNO		NUMBER
CLASS	NOT NULL	VARCHAR2(10)
M1		NUMBER
M2		NUMBER
M3		NUMBER
M4		NUMBER
M5		NUMBER

2. Table Abstract		
Name	Null?	Type
STDNO		NUMBER
STDNAME		VARCHAR2(10)
CLASS		VARCHAR2(10)
MONTH		VARCHAR2(10)
INTNO (INTEGER NUMBER)		NUMBER
TOT		NUMBER
GRADE		VARCHAR2(10)
PERCENT		NUMBER
DAT_ENTER		DATE

A.G & S.G Siddhartha Degree College of Arts & Science, Vuyyuru – 521165.
(An Autonomous College in the jurisdiction of Krishna University)
M.Sc., (Computer Science) Programme - I Semester

Course	Formal Languages and Automata Theory		
Course Code	22CS1T3	Course Delivery Method	Class Room / Blended
Credits	4	CIA Marks	30
No. of Lecture Hours /	4	Semester End Exam	70
Total Number of Lecture Hours	60	Total Marks	100
Year of Introduction: 2020-21	Year of Offering: 2021-22	Year of Revision: 2021-22	Percentage of Revision: 0%

Course Description and Purpose:

Formal Languages and Automata Theory deals with the concepts of *Automata, Formal Languages, Grammar, Algorithms, Computability, Decidability and Complexity*. It also helps to develop methods by which computer scientists can describe and analyze the dynamic behavior of *Discrete Systems*, in which signals are sampled periodically.

Course Objectives:

- To understand basic properties of *Deterministic and Nondeterministic Finite Automata*.
- To understand *Context Free Languages and Grammars*, and also *Normalising CFG*.
- To understand the concept of *Pushdown Automata Turing Machine* and its application.
- To understand Basic Structure of *Compiler Design*.
- To understand the concept of *Lex and Syntax Analysis*.

Course Learning Outcomes:

At the end of this course the students should be able to:

- Understand basic properties of *Deterministic and Nondeterministic Finite Automata*.
- Understand the *Context Free Languages and Grammars*, and also *Normalising CFG*.
- Understand the concept of *Pushdown Automata Turing Machine* and its application.
- Understand Basic Structure of *Compiler Design*.
- Understand the concept of *Lex and Syntax Analysis*.

Unit	Learning Units	Lecture Hours
	<p>Fundamentals: Strings, Alphabet, Language, Operations, Finite Automaton Model, Acceptance of Strings and Languages, Transition Table and Transition Diagrams.</p> <p>Finite Automata: Deterministic Finite Automaton, Non deterministic Finite Automaton and NFA with ϵ Transitions, Significance, Equivalence between NFA with and without ϵ Transitions, NFA to DFA Conversion, Minimization of FSM, Equivalence between two FSMs, Finite Automata with Output-Moore and Mealy Machines.</p>	15
II	<p>Regular Languages: Regular Sets, Regular Expressions, Identity Rules, Construction of Finite Automata(DFA) for a given Regular Expressions and its inter conversion using State Elimination and Ardens Theorem, Pumping Lemma of Regular Sets, Closure Properties of Regular Sets (Proofs not required).</p>	15
III	<p>Context free grammar: Introduction, Derivation Trees, Ambiguity in Context Free Grammars. Minimization of Context Free Grammars. Chomsky Normal Form, Greibach Normal Form.</p> <p>Push down Automata: Definition, Model, Design of PDA. The Language of PDA- Acceptance by Final State, Acceptance by Empty Stack, Equivalence of CFL and PDA -Conversion of CFL to PDA and PDA to CFL</p> <p>Turing Machine: Definition, Turing Machine Model, Types of Turing machine (problems not required), Types of Turing machine, Recursively Enumerable Languages and Recursive Languages Chomsky Hierarchy of Languages and Post correspondence problem.</p>	15
IV	<p>Compiler: Introduction, Structure of a compiler, Design issues of compiler, Phases of Compiler, Lexical Analysis, Role of Lexical Analyzer, Input Buffering, Specification of Tokens, Recognition</p>	15
V	<p>Lex (Lexical-Analyzer Generator): Uses of Lex, Structure of Lex Programs, Conflict Resolution in Lex, The Lookahead Operator. Syntax Analysis: Top Down Parsing, Recursive-Descent Parsing, FIRST and FOLLOW, LL(1) Grammar, Nonrecursive Predictive Parsing, Error Recovery in Predictive Parsing. Bottom-Up Parsing- Reductions, Handle Pruning, Shift-Reduce Parsing, Conflicts During Shift-Reduce Parsing.</p>	15

Prescribed Text Book

	Author	Title	Publisher
1	Hopcroft. H.E. and Ullman	Introduction to Automata Theory Languages and Computation	J. D. Pearson Education, January
1	Jeffery D.Ullman	Compilers-Principles, Techniques and Tools	2 nd Edition, Pearson Education, January
	John C Martin	Introduction to Languages and the Theory of Computation	Tata McGraw-Hill, 2003

A.G & S.G Siddhartha Degree College of Arts & Science, Vuyyuru – 521165.
M.Sc.,(COMPUTER SCIENCE) DEGREE EXAMINATIONS
FIRST SEMESTER

FORMAL LANGUAGES AND AUTOMATA THEORY
SYLLABUS W.E.F 2022-2022 (R22)

Time 3 Hours

Max.Marks: 70

SECTION-A

Answer any five questions. 5 × 4 = 20 Marks

1. (a) What is NFA with example?(BTL1)
(OR)
(b) Define Mealy Machine with example (BTL1)
2. (a) Define regular set .What are the closure properties of regular sets? (BTL1)
(OR)
(b) Define Expression. What are the different identity rules used in regular expression. (BTL1)
3. (a) Explain Ambiguity in context free grammars with example.(BTL2)
(OR)
(b) Explain LMD and RMD with example(BTL2)
4. (a) Define input buffering with example. (BTL1)
(OR)
(b) What is the role of Lexical Analyzer(BTL1)
5. (a) Explain Conflict Resolution in Lex(BTL2)
(OR)
(b) Explain error recovery in predictive parsing. (BTL2)

SECTION-B

Answer all questions. 5 × 10 = 50 Marks

6. (a) Construct the given NFA to DFA. (BTL3) 10 Marks

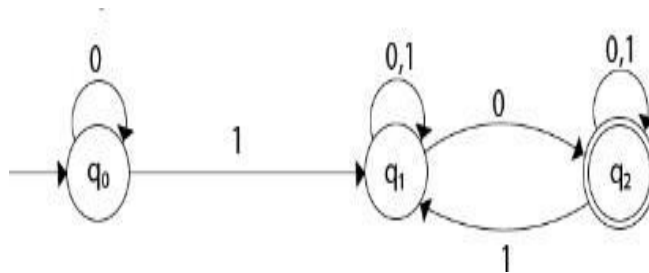

(OR)

- (b) Construct the given DFA into minimized DFA (BTL3)

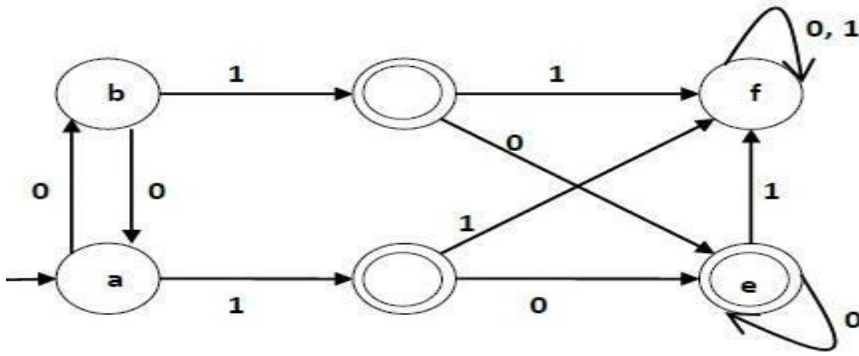

7. (a) Construct a regular expression corresponding to the automata given below (BTL3)

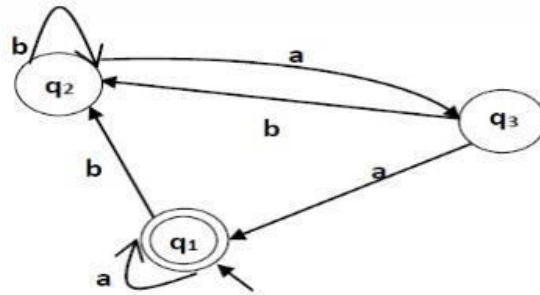

(OR)

(b) Solve the given Language $L = \{0^n 1^n \mid n \geq 1\}$ is not a regular language using pumping lemma (BTL3)

8. (a) Translate the given grammar to CNF (BTL2)

$S \rightarrow aAD$

$A \rightarrow aB / bAB$

$B \rightarrow b$

$D \rightarrow d$

(OR)

(b) Explain Chomsky Hierarchy of Languages and Post correspondence problem with example.(BTL2)

9. (a) what are the design issues of compiler?

(OR)

(b) What are the different phases used in Compiler Design with diagram 10 Marks (BTL1)

10. (a) Define Lex. explain structure of Lex program and its uses(BTL2)

(or)

(b) Explain top down and bottom up parsing with example(BTL2)

A.G & S.G Siddhartha Degree College of Arts & Science, Vuyyuru – 521165.
(An Autonomous College in the jurisdiction of Krishna University)
M.Sc., (ComputerScience)Programme - I Semester

Course	OPERATING SYSTEMS		
Course Code	22CS1T4	Course Delivery Method	Class Room / Blended
Credits	4	CIA Marks	30
No. of Lecture Hours / Week	4	Semester End Exam Marks	70
Total Number of Lecture Hours	60	Total Marks	100
Year of Introduction: 2020-21	Year of Offering:2021-22	Year of Revision:2021-22	Percentage of Revision:100%

Course Description and Purpose:

Operating Systems is a course that illustrates *Operating System Concepts, Operating System Structure, Processes Concepts, Threads, Process Synchronization, Scheduling, Deadlocks, Main Memory, Virtual Memory, Mass Storage Structure, File System Implementation, Distributed Operating Systems and Mobile & Android Operating Systems*

Course Objectives:

This course will help enable the students to understand and learn *Operating System Concepts, Operating Structure, Process Concepts, Thread Concept, Process Synchronization, Scheduling, Deadlocks, Main Memory, Virtual Memory and Mass Storage Structure, File System Implementation, Distributed Operating Systems and Mobile & Android Operating Systems.*

Specific objectives include:

- To understand the *Basic Concepts of Operating System, Operating System Structure and ProcessConcept.*
- To apply concepts of *Threads, Process Synchronization & CUP Scheduling.*
- To understand *Deadlock, Main Memory & Virtual Memory.*
- To explain *Mass Storage Structure, File System Interface & File System Implementation.*
- To understand the concepts of *Distributed Operating Systems and Mobile & Android OperatingSystems.*

Course Learning Outcomes:

Upon successful completion of the course, the student will be able to:

- Understand the Basic Concepts of Operating System, Operating System Structure and ProcessConcept.
- Applying concepts of Threads, Process Synchronization & CUP Scheduling.
- Understand Deadlock, Main Memory & Virtual Memory.
- Explain Mass Storage Structure, File System Interface & File System Implementation.
- Understand the concepts of Distributed Operating Systems and Mobile & Android Operating Systems.

SYLLABUS

Unit	Learning Units	Lecture Hours
I	<p>Introduction to Operating System Concepts: Functions of Operating System, Operating System Structure, Operating System Operations, Kernel Data Structure, Computing Environment.</p> <p>Operating System Structures: Operating System Services, System Calls, Types of System Calls.</p> <p>Processes: Process Concept, Process Scheduling, Operations on Processes, Inter Process Communication, Communication in Client-Server Systems.</p>	15
II	<p>Threads: Overview, Multicore Programming, Multithreading Models, Thread Libraries, Implicit Threading, Threading Issues.</p> <p>Process Synchronization: Background, The Critical Section Problem, Peterson's Solution, Synchronization Hardware, Mutex Locks, Semaphores, Classic Problems of Synchronization, Monitors.</p> <p>CPU Scheduling: Basic Concepts, Scheduling Criteria, Scheduling Algorithms, Thread Scheduling, Multiple Processor Scheduling.</p>	15
III	<p>Deadlocks: System Model, Deadlock Characterization, Methods for Handling Deadlocks, Deadlock Prevention, Deadlock Avoidance, Deadlock Detection, Recovery from Deadlock.</p> <p>Main Memory: Swapping, Contiguous Memory Allocation, Segmentation, Paging, Structure of the Page Table, Intel 32 and 64-bit Architectures.</p> <p>Virtual Memory: Background, Demand Paging, Copy-on-Write, Page Replacement, Allocation of Frames, Thrashing.</p>	15
IV	<p>File System Interface: File Concept, Access Methods, Directory and Disk Structure, File System Mounting, Protection.</p> <p>File System Implementation: File System Structure, File System Implementation, Directory Implementation, Allocation Methods, Free Space Management, Efficiency and Performance, Recovery.</p>	15
V	<p>Distributed Operating Systems: Types of Network based Operating Systems, Network Structure, Network Topology, Communication Structure, Communication Protocols, Robustness, Design Issues.</p> <p>Mobile & Android Operating Systems: A review of Mobile Operating Systems, Features of Android Operating Systems.</p>	15

Prescribed Text Book

	Author	Title	Publisher
1	Abraham Silberschatz & Peter Baer Galvin, Greg	Operating System Concept	Ninth Edition, Wiley, 2015

Reference Text Books

	Author	Title	Publisher
1	William Stallings	Operating Systems-Internals and Design Principles	Fifth Edition, Pearson Education, 2007
2	Achyut S Godbole	Operating Systems	Second Edition, TMH, 2007

A.G & S.G Siddhartha Degree College of Arts & Science, Vuyuru – 521165.

(An Autonomous College in the jurisdiction of Krishna University)

M.Sc.(Computer Science), First Semester

Course Name: Operating Systems

Course Code: 22CS1T4

(w.e.f admitted batch 2022-22)

Time: 3 Hours

Max Marks: 70

SECTION-A

Answer ALL questions. All Questions Carry Equal Marks. (5×4 = 20 Marks)

1. (a) Explain the structure of Operating System. (BTL2)

(or)

(b) Explain *Inter Process Communication*. (BTL2)

2 (a) List various *Multithreading Model*. (BTL1)

(or)

(b) What is *Semaphore*. (BTL1)

3 (a) Test for *Demand Paging*. (BTL4)

(or)

(b) Analyze Paging. (BTL4)

4 (a) Demonstrate the *File Concept* (BTL2)

(or)

(b) Explain various *File Operations*. (BTL2)

5 (a) Construct a *Network Topology*. (BTL3)

(or)

(b) Identify the design issues in *Distributed OS*. (BTL3)

SECTION-B

Answer ALL questions. All Questions Carry Equal Marks. (5×10 = 50 Marks)

6 (a) Explain *Operating System Services*. (BTL2)

(or)

(b) Explain various types *System Calls*. (BTL2)

7 (a) Illustrate the *Dining Philosophers Problem* of Process Synchronization. (BTL2)

(or)

(b) Demonstrate (BTL2)

(i) First-Come, First-Served Scheduling with the following data

Process	Burst Time
P1	24
P2	3
P3	3

(ii) Shortest-Job-First Scheduling with following data

Process	Burst Time
P1	6
P2	8
P3	7
P4	3

- 8 (a) Apply the necessary conditions for preventing *Deadlock Situation*. (BTL3)
(or)
(b) Utilize the reference string 7, 0, 1, 2, 0, 3, 0, 4, 2, 3, 0, 3, 2, 1, 2, 0, 1, 7, 0, 1 for a memory with three frames implement *Optimal Page Replacement* and *LRU PageReplacement*. (BTL3)
- 9 (a) Compare *Single-Level Directory*, *Two Level Directory*, and *Tree-Structured Directories*. (BTL4)
(or)
(b) Categorize various *Allocation Methods* of *File System Implementation*. (BTL4)
- 10 (a) Explain various types of *Network based Operating Systems*. (BTL5)
(or)
(b) Explain features of *Mobile Operating Systems*. (BTL5)

A.G & S.G Siddhartha Degree College of Arts & Science, Vuyyuru – 521165.
(An Autonomous College in the jurisdiction of Krishna University)
M.Sc., (Computer Science) Programme - I Semester

Course	Personality Development through Life Enlightenment skills		
Course Code	22PG101	Course Delivery Method	Class Room / Blended
Credits	4	CIA Marks	30
No. of Lecture Hours / Week	4	Semester End Exam Marks	70
Total Number of Lecture Hours	60	Total Marks	100
Year of Introduction: 2022-23	Year of Offering: 2022-23	Year of Revision: 2022-23	Percentage of Revision: 0%

Course Description and Purpose:

Personality development is the development of your behavior patterns and attitude. It is the result of where we are born" the circle we interact with and our personal temperament. Every person is different. There are some characteristics traits that make you „you". Personality development through life enlightenment course aims to help students identify negative behaviors which may be stopping them from reaching their desired goals. This course will help students both in their personal and desired professional life. The other purposes of personality development through life enlightenment course are to enable you lead stress-free and healthier life, ethical decision making ability" enhanced confidence level, and building a more pleasing personality.

Course Objectives:

At the end of this course the students should be able to:

- Develop their personality and achieve their highest goals of life.
- Lead the nation and mankind to peace and prosperity.
- Practice emotional self regulation.
- Develop a positive approach to work and duties.
- Develop a versatile personality.

Course Learning Outcomes:

At the end of this course the students should be able to:

- Develop their personality and achieve their highest goals of life.
- Lead the nation and mankind to peace and prosperity
- Practice emotional self regulation.
- Develop a positive approach to work and duties
- Develop a versatile personalit

UNIT- I :

Introduction to Personality Development The concept of personality - Dimensions of Personality - Theories of Personality development (Freud & Erickson) - The concept of Success and Failure - Factors responsible for Success - Hurdles in achieving Success and Overcoming Hurdles - Causes of failure - Conducting SWOT (Strengths" Weaknesses, Opportunities and Threats) analysis.

UNIT- II:

Attitude. Motivation and Self-esteem

Conceptual overview of Attitude - Types of Attitudes - Attitude Formation -. Advantages/Disadvantages of Positive,4ltregative Attitude - Ways to Develop Positive Attitude C'oncept of motivation: Definition and Nature of Motivation/Motive * Internal and external motives - Theories of Motivation - Importance of self- motivation- Factors leading to de- motivation. **Self - esteem** - Definition and Nature of self'-esteem - Do's and Don'ts to develop positive self esteem - Low self esteem - Personality having low self esteem - Positive and negative self esteem.

UNIT- III:

Other Aspects of Personality Development Body language - Problem-solving - Contlict Management and Negation skills - Decision-making Skills - Leadership and qualities of a successful leader - Character building - Team-work – Time management - Work ethics - Good manners and etiquette - Emotional Ability/intelligence - Dimensions of Emotional Intelligence - Building Emotional Intelligence.

UNIT- IV:

Neetisatakam-Hol istic Development of Personal ity Verses- 19.20,21"22 (wisdom) - Verses- 29.31,32 (pride and heroism) - Verses- 26.28.63.65 (virrue) Personality of Role Model - Shrimad Bhagwadgeeta Chapter2-Verses 17 - Chapter 3-Verses 36,37,42 - Chapter 4-Verses 18, 38,39 - Chapter18 - Verses 37,38,

UNIT- V:

Yoga & Stress Management Meaning and definition of Yoga - Historical Perspective of Yoga - Principles of Astanga Yoga by Patanjali- Meaning and Definition of Stress - Types of Stress - Eustress and Distress -stress Vmanagement -- Pranayama- Pranayama: Anulom and Vilom Pranayama - Nadishudhi Pranayama - Kapalabhati- Pranayama - Bhramari Pranayama - Nadanusandhana Pranayama * Meditation techniques: Om Meditation - Cyclic meditation : Instant Relaxation technique (QRT). Quick Relaxation'l'echnique (QR'f). Deep Relaxation l'echnique (DRT) (Theory & Practical).

PRACTICAL COMPONENTS:

- Students should identify different types of personality to know their own personality. Students are to describe the characteristics of their personalities and submit the same for assessment.
- Students are to form in groups (a group consists of 4-6 students) to identify and write a brief note on famous personalities of India and World.
- Students are required to identify diff-erent types of attitudes and give any five examples of each.
- Students are expected to check their attitudes and develop ways to improve their attitudes at work place and home.
- Students are required to identify keys to self -motivation to achieve their goals.
- Students are expected to identify at least seven types of body language and conduct activities with the following:

S. No	Pose	Possible Interpretations
	anding with your hands on hips	gressive, disgusted
	anding upright	nfidence
	ms crossed on your chest	fensive
	sting your hand on your cheek	inking
	uching or rubbing your nose	ubt, lying
	sting your head in your hands	redom, Tired
	pping your fingers	patience
	ing your nails	rvous, Insecure
	ying with your hair	ecure
	bbing your eyes	sbelief, doubt

- Conduct the following exercise to develop communication skills - Negotiation Skills and Empathy

Exercise: Card Pieces

In this activity, team members trade pieces of playing cards to put together complete cards.

Uses - This exercise is useful for showing team members others perspectives. It builds communication and negotiation skills, and helps people to develop empathy.

People and Materials :

- Enough people for at least three teams of two.
- Playing cards - use between four and six for each person.
- A private room.

Time - 15 minutes. Instructions:

1. Cut each playing card into half diagonally, then in half diagonally again, so you have four triangular pieces for each card.
2. Mix all the pieces together and put equal numbers of cards into as many envelopes as you have teams.
3. Divide people up into teams of three or four. You need at least three teams. If you're short of people, teams of two will work just as well.
4. Give each team an envelope of playing card pieces.
5. Each team has three minutes to sort its pieces, determine which ones it needs to make complete cards, and develop a bargaining strategy.
6. After three minutes, allow the teams to start bartering for pieces. People can barter on their own or collectively with their team. Give the teams eight minutes to barter.
7. When the time is up, count each team's completed cards. Whichever team has the most cards wins the round.

Advice for the Teacher/Facilitator After the activity, ask your team members to think about the strategies they used. Discuss these questions:

1. Which negotiation strategies worked? Which didn't?
2. What could they have done better?
3. What other skills, such as **active listening** or **empathy**, did they need to use?

Conduct following Time management activity - Ribbon of Life

Take a colored ribbon length of approximately 1 meter/100 cm. and scissors. Start with the following questions :

- ❖ If the life span of an individual is say, 100 years. Consider that each cm represents one year, The response will be that few live that long. Assuming a life of 75 to 90 years, cut 10 to 25 cm of the ribbon, accordingly.
- ❖ What is the average age of the participants sitting here, the response would be 25 to 30 depending on the group, in that case, cut another 25 cms of the ribbon and say that is gone you cannot do anything.
- ❖ What is left is 50 years? People will say, "Yes" but the answer is NO.
- ❖ Every year we have 52 weeks, that is 52 Sundays. If we multiply that by 50 years, it comes to 7.14 years. Reduce the ribbon by another 7.14 cm.
- ❖ We also usually have Saturdays off, so reduce another 7. cms.
- ❖ Public/ National holidays are 10 multiple with 50 years. That comes to another 1.5 years. Reduce ribbon by another 1.5 cms.
- ❖ Your casual leave, sick leave, and annual holidays approx. 40 days a year, multiplied by 50.
- ❖ Your casual leave, sick leave, and annual holidays approx. 40 days a year, multiplied by 50. Cut off another 5 cms. Now you are left with about 29.5 years. But, the calculation is not over yet.
- ❖ You sleep an average of 8 hours daily; multiply that by 365 days and again by 50 years (i.e. 122 days X 50 : almost 17 years). Cut off another 17 cm.
- ❖ You spend time eating lunch, breakfast, snacks, and dinner total 2 hours daily (i.e. 30 days a year X 50 years = 4 years or so). Cut off another 4cm.
- ❖ Last, let's figure we spend about 1 hour a day traveling from place to place for activities and such. (that's about 2 more years). We're down to 6 (SIX) years of life to make it or break it.

Exercise Decision making skills - Create Your Own

In this exercise, teams must create their own, brand new, problem-solving activity.

APPENDIX-II**RUBRICS FOR ALLOCATING MARKS FOR LABORATORY EXAMINATIONS AND PROJECT WORK**

- Scheme of Evaluation of Internal Laboratory Examination

Viva	Written Procedure	Execution	Total Marks
5 Marks	5 Marks	20 Marks	30 Marks

- Scheme of Evaluation of External Laboratory Examination

Record	Viva	Written Procedure	Execution	Total Marks
10 Marks	10 Marks	10 Marks	40 Marks	70 Marks

- Internal assessment of Project Work will be done by the concerned Project Internal Guide and HOD for 100 Marks.

Evaluation Schema for Continuous Internal Assessment of Project Work

Review-I	Submission of Abstract	20 Marks
Review-II	Submission of Data Dictionary & UML/ER Diagrams	20 Marks
Review-III	Project Execution	30 Marks
Record Submission		30 Marks
Total		100 Marks

- External evaluation will be carried out by the External Examiner appointed by the Controller of Examinations for 100 Marks

Evaluation Schema for External Assessment of Project Work for

Project Record	20 Marks
Execution	50 Marks
Viva Voce	30 Marks
Total	100 Marks

- External evaluation will be carried out by the External Examiner appointed by the Controller of Examinations for 200 Marks

Evaluation Schema for External Assessment of Project Work for

Project Record	40 Marks
Execution	100 Marks
Viva Voce	60 Marks
Total	200 Marks

- Every faculty member must guide a minimum of five students in Project Work off the designated workload



A.G & S.G Siddhartha Degree College of Arts & Science, Vuyyuru – 521165.
(An Autonomous College in the jurisdiction of Krishna University)
M.Sc., (Computer Science) Programme – III Semester

Course	Internet of Things		
Course Code	22CS3E5	Course Delivery Method	Class Room / Blended
Credits	4	CIA Marks	30
No. of Lecture Hours / Week	4	Semester End Exam	70
Total Number of Lecture Hours	60	Total Marks	100
Year of Introduction:2020-21	Year of Offering:2021-	Year of Revision:2021-22	Percentage of Revision: 0%

Course Objective: To understand and gain knowledge on *Over View of Internet of Things, Models, Layers & Standardization, Protocols & Design Principles* for Connected Devices, *Internet Connectivity Principles, Protocols & Application Layer Protocols, Data Acquiring, Business Models and Business Processes.*

Course Outcomes: On successful completion of the course student will be able to:

CO1: Attain knowledge over view of *Internet of Things.*

CO2: Understand *Models, Layers & Standardization.*

CO3: Apply *Protocols & Design Principles* for Connected Devices.

CO4: Understand *Internet Connectivity Principles, Protocols & Application Layer Protocols.*

CO5: Understand *Data Acquiring, Business Models and Business Processes.*

Syllabus

Unit	Learning Units	Lecture Hours
I	The Internet of Things: An Overview of Internet of Things, Internet of Things Technology, Behind IoT Sources of the IoT, M2M Communication, Examples of IoT, Design Principles for Connected Devices, Business Models for Business Processes in the Internet of Things.	12
II	Design Principles for Connected Devices: IoT / M2M systems layers and Designs Standardizations, Modified OSI Stack for the IoT / M2M Systems, ETSI M2M Domains and High-level Capabilities ,Communication Technologies, Data Enrichment and Consolidation and Device Management Gateway ease of Designing and Affordability.	12
III	Design Principles for the Web Connectivity: Design Principles for the Web Connectivity for Connected Devices, Web Communication Protocols for Connected Devices, Message Communication Protocols for Connected Devices, Web Connectivity for Connected Devices.	12
IV	Internet Connectivity Principles: Introduction, Internet Connectivity, Application Layer Protocols: <i>HTTP, HTTPS, FTP, Telnet</i> .	12
V	Data Acquiring, Organizing and Analytics in IoT / M2M: Introduction, Applications / Services / Business Processes, IOT / M2M Data Acquiring and Storage, Business Models for Business Processes in the Internet of Things, Organizing Data, Transactions, Business Processes, Integration and Enterprise Systems.	12

Prescribed Text Book

	Author	Title	Publisher
1	Rajkamal	Internet of Things: Architecture, Design Principles and Applications	McGraw Hill Higher Education

Reference Text Book

	Author	Title	Publisher
1	Adrian McEwen and Hakim Cassimally	Designing the Internet of Things	Wiley
2	CunoPfister	Getting Started with the Internet of Things.	Oreilly

Course Focus: Employability

Websites of Interest:

1. <https://dzone.com/iot-developer-tutorials-tools-news-reviews>
2. <https://www.ibm.com/blogs/internet-of-things/>

A.G & S.G Siddhartha Degree College of Arts & Science, Vuyyuru – 521165.
(An Autonomous College in the jurisdiction of Krishna University)
M.Sc., (Computer Science) Programme –III Semester

Title: Internet of Things (IoT)

Time: 3 Hours

Max. Marks: 70

SECTION-A

1. Answer ALL questions

(10x2 = 20 Marks)

1. a) What is *M2M Communication*. (BTL1)
- b) What are *Connected Devices*? (BTL1)
- c) Write about *Modified ISO*. (BTL1)
- d) What is a *Gateway*? (BTL1)
- e) What is *Communication Protocol*? (BTL1)
- f) What is *Resource and Resource Repository*? (BTL1)
- g) What is *Header*? Explain *TCP Header*. (BTL1)
- h) What is *Protocol Data Unit and Maximum Transferable Unit*. (BTL1)
- i) Write about *Event Data*. (BTL1)
- j) What are *Active and Passive Devices*? (BTL1)

SECTION-B

Answer Five Questions Choosing One Question from Each Unit.
All Questions Carry Equal Marks.

(5x10=50 Marks)

UNIT – I

- 2) a) Explain an overview of IOT. (BTL2)
- (or)
- b) Explain M2M Communication. (BTL2)

UNIT – II

- 3) a) Explain various *Layers & Design Standardization Principles* of IOT. (BTL2)
- (or)
- b) Explain different *communication technologies* used in IOT. (BTL2)

UNIT – III

- 4) a) What are *Web Communication Protocols* for Connected Devices? (BTL1)
- (or)
- b) What are various *Design Principles* for the Web Connectivity? (BTL1)

UNIT – IV

- 5) a) Explain in detail *Internet Connectivity Principles*. (BTL5)
- (or)
- b) Explain any two *Application Layer Protocols*. (BTL5)

UNIT – V

- 6) a) Illustrate *Business Models* for *Business Processes* in the Internet of Things. (BTL2)
- (or)
- b) Explain *Integration and Enterprise Systems*. (BTL2)

A.G & S.G Siddhartha Degree College of Arts & Science, Vuyyuru – 521165.
(An Autonomous College in the jurisdiction of Krishna University)
M.Sc., (Computer Science) Programme - III Semester

Course	Cryptography & Network Security		
Course Code	22CS3E3	Course Delivery	Class Room / Blended
Credits	4	CIA Marks	30
No. of Lecture Hours / Week	4	Semester End Exam	70
Total Number of Lecture Hours	60	Total Marks	100
Year of Introduction:2020-21	Year of Offering:2021-22	Year of Revision:2021-22	Percentage of Revision:0%

Course Objective: To understand and gain knowledge on *Computer & Network Security, Number Theory, Classical Encryption Techniques, Advanced Encryption Standard and Random Bit Generation and Stream Ciphers, Number Theory, Public Key Cryptography and RSA, Other Public-Key Crypto Systems and Message Authentication Codes, Digital Signatures, Key Management and Distribution and User Authentication, Transport Level Security, Electronic Mail Security and IP Security and Intruders and Firewalls.*

Course Outcomes: On successful completion of this course, the students will be able to:

CO1 : Understand Computer & Network Security Concepts, Classical Encryption Techniques and Advanced Encryption Standard.

CO2 : Gain knowledge on *Number Theory, Public Key Cryptography and RSA, Other Public-Key Crypto Systems and Message Authentication Codes.*

CO3 : Know Digital Signatures, Key Management and Distribution and User Authentication.

CO4 : Understand *Transport Level Security, Electronic Mail Security and IP Security.*

CO5 : Gain knowledge about *Intruders and Firewalls.*

SYLLABUS

Unit	Learning Units	Lecture Hours
I	<p>Computer & Network Security Concepts: Computer Security Concepts, The OSI Security Architecture, Security Attacks, Security Services, Security Mechanisms, A Model for Network Security.</p> <p>Classical Encryption Techniques: Symmetric Cipher Model, Substitution Techniques, Transposition Techniques</p> <p>Advanced Encryption Standard: AES Structure, An AES Example, AES Implementation. Random Bit Generation and Stream Ciphers: Principles of Pseudo Random Number Generation, Pseudo Random Number Generators.</p>	12

II	<p>Introduction to Number Theory: Divisibility and the Division Algorithm, The Euclidean Algorithm, Modular Arithmetic, Prime Numbers, Fermat's and Euler's Theorems, Testing for Primality, The Chinese Remainder Theorem, Discrete Logarithms.</p> <p>Public Key Cryptography and RSA: Principles of Public Key Crypto Systems, The RSA Algorithm.</p> <p>Other Public-Key Crypto Systems: Key Management, Diffie-Hellman Key Exchange, Elliptic Curve Arithmetic, Elliptic Curve Cryptography.</p> <p>Message Authentication Codes: Message Authentication Requirements, Message Authentication Functions, Requirements for Message Authentication Codes, Security of MACs, MACs Based on Hash Functions: HMAC.</p>	12
III	<p>Digital Signatures: Digital Signatures, NIST Digital Signature Algorithm.</p> <p>Key Management and Distribution: Symmetric Key Distribution Using Asymmetric Encryption, Distribution of Public Keys.</p> <p>User Authentication: Kerberos, Remote User-Authentication Using Asymmetric Encryption.</p>	12
IV	<p>Transport Level Security: Transport Layer Security.</p> <p>Electronic Mail Security: S/MIME, Pretty Good Privacy.</p> <p>IP Security: IP Security Overview, IP Security Policy, Encapsulating Security Payload, Combining Security Associations.</p>	12
V	<p>Intruders: Intruders, Intrusion Detection, Password Management.</p> <p>Firewalls: The Need for Firewalls, Firewall Characteristics and Access Policy, Types of Firewalls.</p>	12

Prescribed Text Book			
	Author	Title	Publisher
1	William Stallings	Cryptography and Network Security	Pearson, Seventh Edition, 2017
Reference Text Book			
	Author	Title	Publisher
1	William Stallings	Cryptography and Network Security	Pearson, Sixth Edition, 2014
2	William Stallings	Network Security Essentials- Applications and Standards	Pearson Education (2007), Third Edition.
3	Chris McNab	Network Security Assessment	O'Reilly (2007), 2 nd Edition
4	Jon Erickson	Hacking-The Art of Exploitation	Press (2006), SPD
5	Neal Krawety	Introduction to Network Security	Thomson (2007).

Course has focus on : Employability

Websites of Interest :

1. https://www.pearsonhighered.com/assets/hip/us/hip_us_pearsonhighered/preface/0132775069.pdf
2. <http://faculty.mu.edu.sa/public/uploads/1360993259.0858Cryptography%20and%20Network%20Security%20Principles%20and%20Practice,%205th%20Edition.pdf>

Co-curricular Activities : Programming Contests, Hackathons & Quiz.

Time: 3 Hours

Max. Marks: 70

SECTION-A

Answer ALL questions

(10×2 = 20 Marks)

- 1) a) What is *Caesar Cipher*? (BTL1)
- b) Write any two characteristics of Randomness. (BTL1)
- c) What is the Purpose of the *Euclidean Algorithm*? (BTL1)
- d) What is Message Encryption? (BTL1)
- e) What is the difference between *Symmetric Key Distribution* & *Asymmetric Key Distribution*? (BTL1)
- f) What is *Mutual Authentication*? (BTL1)
- g) State any two Protocols of *Transport Layer Security*. (BTL1)
- h) What is *Pretty Good Privacy*? (BTL1)
- i) What is *Firewall*? (BTL1)
- j) State any two *Intrusion Detection Techniques*. (BTL1)

SECTION-B

Answer Five Questions Choosing One Question from Each Unit.

All Questions Carry Equal Marks.

(5×10 = 50 Marks)

UNIT- I

- 2) a) Explain various *Security Attacks* and *Security Services*. (BTL2) 10 Marks
- (or)
- b) Explain *AES Encryption* and *Decryption Process*. (BTL2) 10 Marks

UNIT- II

- 3) a) Illustrate *Diffie-Hellman Key Exchange*. (BTL2) 10 Marks
- (or)
- b) Explain *Internal and External Error Control* in Message Authentication Functions. (BTL2) 10 Marks

UNIT-III

- 4) a) Explain *NIST Digital Signature Algorithm* with diagram. (BTL5) 10 Marks
- (or)
- b) Explain *Kerberos* in detail. (BTL5) 10 Marks

UNIT-IV

- 5) a) Explain *Confidentiality* and *Authentication* in S/MIME (BTL5) 10 Marks
- (or)
- b) Illustrate *Overview of IP Security*. (BTL5) 10 Marks

UNIT-V

- 6) a) Discuss what are the problems that may intruder create and explain how to overcome those problem? (BTL6) 10 Marks
- (or)
- b) Discuss *Various Types of Firewalls*. (BTL6) 10 Marks

UNIT – V

- 7) a) Illustrate *Business Models* for *Business Processes* in the Internet of Things. (BTL2)
- (or)
- b) Explain *Integration and Enterprise Systems*. (BTL2)

A.G & S.G Siddhartha Degree College of Arts & Science, Vuyyuru – 521165.
(An Autonomous College in the jurisdiction of Krishna University)
M.Sc., (ComputerScience)Programme - III Semester

Course	Design & Analysis of Algorithms		
Course Code	22CS3E1	Course Delivery Method	Class Room / Blended
Credits	4	CIA Marks	30
No. of Lecture Hours /	4	Semester End Exam	70
Total Number of Lecture Hours	60	Total Marks	100
Year of Introduction:2020-21	Year of Offering:2021-22	Year of Revision:2021-22	Percentage of Revision: 0%

Course Objective: The objective of this course is to develop proficiency in *Problem Solving and Programming, To Perform Analysis of various Algorithms in regard to Time and Space Complexity, Gain good understanding of Applications of Data Structures, To develop a base for Advanced Study in Computer Science, To apply Design Techniques to solve different types of problems as per their Complexity and Develop ability to segregate NP- Hard and NP-Complete problems.*

Course Outcomes: On successful completion of this course, the students will be able to:

CO1 : Understand *Basic Ideas* about *Analysis of Algorithms and the Concept of Data Structures.*

CO2 : Know *Divide and Conquer ,Greedy Methods* and *Solving Various Problems* by applying them. **CO3 :** Apply *Dynamic Programming Method* and *Basic Traversal and Search Techniques* to solve various Problems.

CO4 : Understand *Backtracking* and *Branch and Bound* Techniques to Design Algorithms.

CO5 : Categorize *NP-Hard* and *NP-Complete* Problems.

Syllabus

Unit	Learning Units	Lecture Hours
I	<p>Introduction: What is Algorithm, Algorithm Specification Pseudo code Conventions, Recursive Algorithms, Performance Analysis: Space Complexity Time Complexity, Asymptotic Notation, Performance Measurement, Randomized Algorithms: Basics of Probability Theory, Randomized Algorithms Identifying the Repeated Element, Primality Testing: Advantages and Disadvantages.</p> <p>Elementary Data Structures: Stacks and Queues, Trees: Terminology, Binary Trees, Dictionaries: Binary Search Trees, Priority Queues, Heaps , Heapsort , Sets and Disjoint Set Union: Introduction-Union and Find Operations, Graphs: Introduction, Definitions, graph representations.</p>	10
II	<p>Divide-and-Conquer: General Method, Defective Chess Board, Binary Search, Finding Maximum and Minimum, Merge Sort, Quick Sort, Selection Problem, Strassen's Matrix Multiplication, Convex Hull: Some Geometric Primitives, The Quick Hull Algorithm, Graham's Scan, An $O(n \log n)$ Divide and Conquer Algorithm.</p> <p>The Greedy Method: The General Method, Container Loading, Knapsack Problem, Tree Vertex Splitting, Job Sequencing with Deadlines, Minimum Cost Spanning Trees: Prim's Algorithm, Kruskal's Algorithm, Optimal Storage on Tapes, Optimal Merge Patterns, Single Source Shortest Paths.</p>	14
III	<p>Dynamic Programming: The General Method, Multi Stage Graphs, All Pairs Shortest Paths, Single Source Shortest Paths, Optimal Binary Search Trees, String Editing -0/1 Knapsack, Reliability Design, The Traveling Sales Person Problem, Flow Shop Scheduling. Basic Traversal and Search Techniques: Techniques for Binary Trees, Techniques for Graphs: Breadth First Search and Traversal-Depth First Search, Connected Components and Spanning Trees, Bi-Connected Components and DFS.</p>	17
IV	<p>Backtracking: The General Method, The 8-Queens Problem, Sum of Subsets, GraphColoring, Hamiltonian Cycles, Knapsack Problem.</p> <p>Branch and Bound : The Method: Least Cost Search, The 15 Puzzle Control Abstractionsfor LC Search, Bounding, FIFO Branch and Bound , LC Branch and Bound, 0/1 Knapsack Problem, LC Branch and Bound Solution, FIFO Branch and Bound Solution, TravelingSales person.</p>	11
V	<p>NP-Hard and NP-Complete Problems: Basic Concepts: Non Deterministic Algorithms, The Classes NP Hard and NP Complex, Cook's Theorem, NP Hard Graph Problems, Clique Decision Problem, Node Cover Decision Problem Chromatic Number Decision Problem, Directed Hamiltonian Cycle, Traveling Sales Person Decision Problem, AND/OR Graph Decision Problem, NP-Hard Scheduling Problems, Scheduling Identical Processors, Flow Shop Scheduling, Job Scheduling, NP-Hard Code Generation Problems, Code Generation With Common Sub Expressions, Implementing Parallel Assignment Instructions, Some Simplified NP-Hard Problems.</p>	8

Prescribed Text Book

S.No	Author	Title	Publish er
1	Sartaj Sahni	Fundamentals of Computer Algorithms	Second Edition, Universities Press(2008)

Reference Text Books

S.No.	Author	Title	Publisher
1	Anany Levitin	Introduction to the Design & Analysis of	Second Edition, Pearson
2	I.Chandra Mohan	Design and Analysis of Algorithms	PHI
3	Prabhakar Gupta, Vineet Agrawal	Design and Analysis of Algorithms	PHI
4	Parag Himanshu, Dave	Design and Analysis of Algorithms	Pearson Education (2008)

Course Focus: Foundation / Skill Development.

Reference Websites :

1. <https://epgp.inflibnet.ac.in/Home>
2. <https://ocw.mit.edu/courses/electrical-engineering-and-computer-science/6-046j-design-and-analysis-of-algorithms-spring-2015/lecture-notes/>
3. https://www.cukashmir.ac.in/cukashmir/User_Files/imagefile/DIT/StudyMaterial/DAA/DAA_UNIT- I_6th-Sem_StudyMaterial.pdf

A.G & S.G Siddhartha Degree College of Arts & Science, Vuyyuru – 521165.

(An Autonomous College in the jurisdiction of Krishna University)

M.Sc., (Computer Science) Programme – III Semester

Title: DESIGN AND ANALYSIS OF ALGORITHMS

Time: 3 Hours

Max. Marks: 70

SECTION-A

Answer ALL questions

(10×2 = 20 Marks)

1. a) Define *Algorithm*. (BTL1)
- b) What is a *priority queue*? (BTL1)
- c) Define *Convex Hull*. (BTL1)
- d) What is *tree vertex splitting*? (BTL1)
- e) What is *String Editing*? (BTL1)
- f) Differentiate *DFS and BFS*. (BTL1)
- g) What is *Graph colouring*? (BTL1)
- h) What is *LC and FIFO Branch and Bound*? (BTL1)
- i) Compare *NP hard and NP complete classes*. (BTL1)
- j) What is *flow shop scheduling in NP Hard Scheduling problems*? (BTL1)

SECTION-B

Answer Five Questions Choosing One Question from Each Unit.

All Questions Carry Equal Marks.

(5×10 = 50 Marks)

UNIT – I

- 2) A) Explain *Asymptotic Notations* regarding time and space complexities of an algorithm. (BTL2)
- (or)
- B) Explain in detail about *Heap Sort Technique* with an example. (BTL2)

UNIT – II

- 3) A) What is *Divide and Conquer approach*? Apply it on *Quick Sort* with an example. (BTL2)
- (or)
- B) What is *Greedy method*? Explain *Kruskal's Algorithm* to find *minimum cost spanning tree* with an example. (BTL2)

UNIT – III

- 4) A) Explain the application of *Dynamic Programming* on *Travelling Salesman Problem*. (BTL2)
- (or)
- B) Explain the procedure to obtain *Optimal Binary Search Tree* by applying *Dynamic Programming* approach. (BTL2)

UNIT – IV

- 5) A) What is *0/1-Knapsack Problem*? Solve it using *Branch and Bound* technique. (BTL2)
- (or)
- B) Explain the *Sum of Subsets Problem*. How can it be solved using *Back Tracking Technique*? (BTL2)

UNIT – V

- 6) A) Write *Cook's theorem*. Briefly explain *Cook's theorem*. (BTL2)
- (or)
- B) Discuss various *NP Hard Graph Problems*. (BTL2)

A.G & S.G Siddhartha Degree College of Arts & Science, Vuyyuru – 521165.

(An Autonomous College in the jurisdiction of Krishna University)

M.Sc., (ComputerScience)Programme - III Semester

Course	Data Mining Techniques		
Course Code	22CS3E2	Course Delivery Method	Class Room / Blended
Credits	4	CIA Marks	30
No. of Lecture Hours /	4	Semester End Exam	70
Total Number of Lecture Hours	60	Total Marks	100
Year of Introduction:2020-21	Year of Offering:2021-22	Year of Revision:2021-22	Percentage of Revision: 0%

Course Objective:

To understand and gain knowledge on *Basic Concepts, Applications, Techniques of Data Mining, Data Warehouse Architecture and its Components, Schemas, Different OLAP Operations, Characterize The Kinds of Patterns that can be discovered by Association Rule Mining, Data Classification and Prediction Techniques, Identify the Similarities among the data Using Clustering Algorithms and Outlier Analysis.*

Course Outcomes: On successful completion of this course, the students will be able to

CO1: Understand the *Basics of Data Mining and Data Pre-Processing Techniques.*

CO2: Aware of constructing the *Data Warehouse, OLAP and relevant Data Model Concepts.*

CO3: Understand the *Frequent Itemset Mining Methods* and Different Levels in Association Rules.

CO4: Understand the *Basic Concepts in Classification and Advanced Classification Methods* by implementing *Various Algorithms.*

CO5: Find the similarities among the data using *Clustering Algorithms and Outlier Analysis.*

Syllabus

Unit	Learning Units	Lecture Hours
I	<p>Introduction: What is Data mining?, What Kind of Data can be Mined, What kinds of Patterns can be Mined, Major Issues in Data Mining.</p> <p>Data Preprocessing: Data Preprocessing : An Overview, Data Cleaning, Data Integration, Data Reduction-Overview of Data Reduction Strategies, Attribute Subset Selection, Regression and Log Linear Models, Histograms and Clustering, Data Transformation : Data Transformation Strategies Overview, Data Transformation by Normalisation, Discretization by Binning.</p>	12
II	<p>Data Warehousing and OLAP: Data Warehouse : Basic Concepts, What Is a Data Warehouse?, Difference between Operational Database Systems and Data Warehouses, Why have a separate Data Warehouse?, Data Warehousing : A Multiered Architecture, Data Warehouse Models, Extraction, Transformation and Loading, Metadata Repository, Data Warehouse Modeling : Data Cube and OLAP-A Multidimensional Data Mode-From Tables and Spreadsheets to Data Cubes, Stars, Snowflakes and Fact Constellations : Schemas for Multidimensional Data Models , Dimensions : The Role of Concept Hierarchies, Measures: their categorisation and computation, Typical OLAP Operations in the Multidimensional Data Model, A Starnet Query Model for Querying Multidimensional Databases.</p>	12
III	<p>Mining Frequent patterns, Associations: Basic Concept, Market Basket Analysis : A Motivational Example, Frequent Item Sets, Closed Item Sets and Association Rules, Frequent Item Set Mining Methods.</p> <p>Advanced Pattern Mining: Pattern Mining : A Road Map, Pattern Mining in Multilevel, Multidimensional Space, Mining Multilevel Association Rules, Mining Multi Dimensional Associations, Mining Quantitative Association Rules.</p>	12
IV	<p>Classification: Basic Concepts: What is Classification?, General Approaches to Classification, Decision Tree Induction, Attribute Selection Measures, Tree Pruning, Scalability and Decision Tree Induction, Bayes Classification Methods, Bayes Theorem, Navie Bayesian Classification.</p> <p>Classification: Advanced Methods: Bayesian Belief Networks, Concepts and Mechanisms, Training Bayesian Belief Networks, Classification by Back Propagation.</p>	12
V	<p>Cluster Analysis Introduction: What is Cluster Analysis?, Requirements for Cluster Analysis, A Partitioning Methods : K-Means, K-Medoid, Hierarchical Methods : Agglomerative versus Divisive Hierarchical Clustering, Distance Measures in Algorithmic Methods, BRICH : Multiphase Hierarchical Clustering using Clustering Feature Trees, Chameleon Hierarchical Clustering, Density Based Methods : DBSCAN. Outlier Detection: What is Outliers Analysis?, Types of Outliers, Challenges of Outlier Detection.</p>	12

Text Books			
	Author	Title	Publisher
1	Jiawei Han, Micheline Kamber	Data mining : Concepts & Techniques	Morgan Kaufmann 3 rd Edition Chapter-1 1.2,1.3,1.4,1.7 Chapter-3 3.1,3.2,3.3,3.4(3.4.1,3.4.4,3.4.5,3.4.6,3.4.7) Chapter-4 4.1 to 4.2 Chapter-6 6.1 to 6.2 Chapter-7 7.1,7.2(7.2.1 to 7.2.3) Chapter-8 8.1,8.2(8.2.1,8.2.2,8.2.3,8.2.4),8.3 Chapter-9 9.1 to 9.2 Chapter-10 10.1,10.2,10.3(10.3.1,10.3.2,10.3.3,10.3.4),10.4(10.4.1) Chapter-12 12.1(12.1.1,12.1.2,12.1.3)

Reference Books			
	Author	Title	Publisher
1	Ralph Kimball	The Data Warehousing Toolkit	Wiley
2	S.N.Sivanandam, S.Sumathi	Data Mining-Concepts, Tasks and Techniques	Thomson

Websites of Interest:

1. www-db.stanford.edu/~ullman/mining/mining.html : Data mining lecture notes.
2. ocw.mit.edu/ocwweb/slon-School-of-management/15-062Data-Mining Spring2003/course

Course Focus: Foundation / Employability / Skill Development.

A.G & S.G Siddhartha Degree College of Arts & Science, Vuyyuru – 521165.
(An Autonomous College in the jurisdiction of Krishna University)
M.Sc., (Computer Science) Programme – III Semester
Title: DATA MINING

TECHNIQUES

Time: 3 Hours

Max. Marks: 70

Answer ALL questions

(10×2 = 20 Marks)

1. a) Difference between *Data Mining* and *KDD* (BTL4)
- b) What is meant by *Data Preprocessing*? (BTL1)
- c) Define *Multidimensional Data model*. (BTL1)
- d) OLAP versus OLTP (BTL4)
- e) Give one example for *Closed Itemset* and *Maximal Frequent Itemset* (BTL1)
- f) What is meant by *Association Rule*? (BTL1)
- g) Explain *Bayes Theorem*. (BTL2)
- h) Define *Classification* with Example. (BTL1)
- i) What are the requirements of *Cluster Analysis*? (BTL1)
- j) What is meant by *Outliers*? (BTL1)

SECTION-B

Answer Five Questions Choosing One Question from Each Unit.

All Questions Carry Equal Marks.

(5×10 = 50 Marks)

UNIT – I

- 2) A) Define Data Mining. What kinds of Patterns can be mined in *Data Mining*. 10M (BTL1)
- (or)
- B) Define *Data Integration*. What are the *Different Techniques used in Data Integration*. 10M (BTL1)

UNIT – II

- 3) A) Define *Data Warehouse*. Explain *Data Warehouse Architecture* with neat Diagram. 10M (BTL1)
- (or)
- B) What are the different types of *Schemas* used in *Multi Dimensional Data Model*? 10M (BTL1)

UNIT – III

- 4) A) Explain *Aprior Algorithm* with Example. 10M (BTL2)
- (or)
- B) Explain *Multi Level and Multi Dimensional Association Rules* with Examples. 10M (BTL2)

UNIT – IV

- 5) A) Explain *Decision Tree Induction Algorithm* with Example. 10M (BTL5)
- (or)
- B) Explain *Naïve Bayes Classification* with Example. 10M (BTL5)

UNIT – V

- 6) A) Explain *Different Partitioning Methods* used in *Cluster Analysis*. 10M (BTL2)
- (or)
- B) Explain in detail about *Hierarchical Clustering*. 10M (BTL2)

A.G & S.G Siddhartha Degree College of Arts & Science, Vuyyuru – 521165.

(An Autonomous College in the jurisdiction of Krishna University)

M.Sc., (ComputerScience)Programme - III Semester

Course	Web Technologies Lab		
Course Code	22CS2L2	Course Delivery Method	Class Room / Blended
Credits	4	CIA Marks	30
No. of Lecture Hours / Week	4	Semester End Exam Marks	70
Total Number of Lecture Hours	60	Total Marks	100
Year of Introduction:2020-21	Year of Offering:2021-22	Year of Revision:2021-22	Percentage of Revision: 0%

Course Objective: Able to build functional *Web Applications using HTML*, Able to use *JavaScript and DHTML* for *Web Designing*, Able to code using XML and PHP for *Integrating with Web Pages*, *Create Dynamic Web Pages* where in client interaction is facilitated using advanced server technology like *JSP* and *Web Pages with Database Connectivity using PHP*.

Course Outcomes: On successful completion of the course student will be able to:

CO1: Build functional *Web Applications HTML*.

CO2: Incorporates *Multimedia Capabilities* and *Web Page Designs* using *Cascading Style Sheets*.

CO3: Code *Client Server Interaction Programs* using *Java Based Server Technology* named *Servlets*.

CO4: Create *Dynamic Web Pages* where in *Client Interaction* is facilitated using *Advanced Server Technology* like *JSP*.

CO5: Integrate *Offline Data Storage*, *Background Processes* and *APIs* using *Database Connectivity* and *ASP*.

Web technology Lab Syllabus

Course Details

HTML:

1. Develop HTML code to provide intra document linking. (BTL6)
2. Develop HTML code to provide inter document linking. (BTL6)
3. Develop a program to implement the three types of lists. (BTL6)
4. Create a HTML page using frames. (BTL6)
5. Develop a program to embed college picture into your web page and develop a short note on your college using paragraph tag. (BTL6)
6. Illustrate a suitable example; depict how we can align text using a table tag as follows. (BTL2)

II M.C.A	Pass percenetage=95%
	Fail percentage=5%
III M.C.A	Pass percenetage=97%
	Fail percentage=3%

7. Develop a program to create the time table as follows: (BTL6)

	1	2	3		4	5	6
MON	<-----WEB LAB----->				SE	WEB	PPL
TUE	UML	CRY	SE	B R E A K	<-----VB LAB----->		
WED	WEB	SE	UML		CRY	PPL	
THU	CRY	WEB	PPL		<-----WEB LAB----->		
FRI	<-----VB LAB----->				PPL	WEB	UML
SAT	SE	CRY	UML		<-----SEMINARS----->		

8. Create a Registration form that interacts with the user. Collect login name, password, date of birth, sex, address, qualification and display a "Thank you for registering" message when the user submits the form. (BTL6)

Login name:
 Enter Password:
 Reenter Password:
 Birthdate:
 Sex: Male Female
 Enter Address:
 Enter qualification:

Java Script:

9. Develop a script to compare two strings using String object. (BTL6)
10. Develop a script to generate random numbers within 1 to 10 and display the numbers in a table. (BTL6)
11. Develop a Java Script to update the information into the array, in the “onClick” event of the button“Update”. (BTL6)
12. Create a web page for a shopping mall that allows the user to tick off his purchases and obtain the bill withthe total being added up simultaneously. (BTL6)

Item details	Price of item	Click here to select
	8399	<input type="checkbox"/>
	5000	<input checked="" type="checkbox"/>
	450	<input checked="" type="checkbox"/>
	399	<input type="checkbox"/>
YOUR TOTAL BILL IS 5450		

13. Develop a script to find the duplicate elements of an array. (BTL6)
14. Develop a script which generates a different greeting each time the script is executed. (BTL6)
15. Develop a JavaScript to check the number is Armstrong number or not by getting the number from textbox and the result is displayed in a alert dialog box. (BTL6)
16. Develop a java script code that accepts user name and password from user, Check their correctness and display appropriate alert messages. (BTL6)

DHTML:

17. Create an inline style sheet. Illustrate the use of an embedded style sheet. (BTL6)
18. Create an external style sheet to illustrate the “Font” elements. (BTL6)
19. Develop a program to switch on and off light using onClick event. (BTL6)
20. Illustrate different types of filters (at least six) on a sample text. (BTL2)
21. Develop a program to illustrate tabular data control for data binding. (BTL6)

XML:

22. Create a small XML file designed to contain information about student performance on a module. Each student has a name, a roll number, a subject mark and an exam mark. (BTL6)
23. Create a internal DTD file. (BTL6)
24. Create an external DTD file. (BTL6)
25. Create a XSLT style sheet to display the student data as an HTML table. (BTL6)

PHP:

26. Illustrate PHP declarations and expressions to find factorial of a given number using. (BTL2)
27. Develop a PHP program that interacts with the user .Collect first name last name and date of birth and displays that information back to the user. (BTL6)
28. Develop a PHP program to connect MySQL Database.

JSP:

29. Develop a program to implement JSP directives. (BTL6)
30. Develop a JSP program for session tracking. (BTL6)

Prescribed Textbook			
	Author	Title	Publisher
1	N.P.Gopalan, J.Akilandeswari	Web Technologies-A Developer's Perspective	PHI(2008)
2	Harvey M. Deitel and Paul I. Deitel	Internet and World Wide Web How To Program, 5e	Prentice Hall; 4th edition

Course Focus: Employability

Websites of Interest:

1. <https://www.w3schools.com>
2. <https://www.edx.org/learn/web-development>
3. <https://www.codecademy.com/learn/paths/web-development>

A.G & S.G Siddhartha Degree College of Arts & Science, Vuyyuru – 521165.
(An Autonomous College in the jurisdiction of Krishna University)
M.Sc., (ComputerScience)Programme – III Semester

Course	Data Mining Lab		
Course Code	20CS3L2	Course Delivery Method	Class Room / Blended
Credits	4	CIA Marks	30
No. of Lecture Hours / Week	4	Semester End Exam Marks	70
Total Number of Lecture Hours	60	Total Marks	100
Year of Introduction:2020-21	Year of Offering:2021-22	Year of Revision:2021-22	Percentage of Revision: 0%

Course Objective:

The main objective of this lab is to impart the knowledge on *How to implement Data Mining Algorithms using Various Tools* and *How to characterize the kinds of Patterns* that can be discovered by *Association Rule Mining, Classification, Clustering, Identifying Outliers* and *Emphasize Hands-onExperience* working with all *Real Time Data Sets*.

Course Outcomes: On successful completion of this course, the students will be able to

CO1: Understand the *Various Kinds of Tools*.

CO2: Apply *Mining Techniques* for *Realistic Data*.

CO3: Understand the *Basic Concepts* in R and *Weka*.

CO4: Understand how to import and export *CSV Files* and *Package* installation in R.

CO5: Develop and visualization of *Data Mining Algorithms* in R.

Using Weka Tool:

1. How to create and load *Data Set* in Weka. (BTL1)
2. Interpret all the *Categorical (or Nominal) Attributes* and the *Real-Valued Attributes* separately. (BTL2)
3. Construct *Association Rules* using Weka.(BTL6)
4. Construct *Multilayer Perceptron* or *Neural Network*. (BTL6)
5. Construct *Time Series Forecasting* using Weka. (BTL6)
6. Demonstration of preprocessing to remove *Attributes, Instances* and *Perform Discretization* using *datasetweather.arff*. (BTL2)
7. Create *K-Mean Clustering* using Weka.(BTL6)
8. Develop *Decision Tree* by training data set using *Weka*. (BTL6)
9. Create *Hierarchical Clustering* using *Weka*. (BTL6)
10. Identifying and removing *Outliers* using Weka. (BTL1)

Using R Programming:

1. How to import data into R from text and excel files using *read.table()* and *read.csv* functions. (BTL1).
2. Create *Association Rules* using *Aprior Algorithm* in R. (BTL6)
3. Construct *Multilayer Perceptron* or *Neural Network* using R. (BTL6)
4. Apply *Time Series Analysis* using R. (BTL3)
5. Apply *Time Series Forecasting* using R. (BTL3)
6. Apply *Time Series Decomposition* using R. (BTL3)
7. Create *K-Means Clustering Algorithm* using R. (BTL6)
8. Construct *Decision Tree* in R using package *party*. (BTL6)
9. Create *Hierarchical Clustering* using R. (BTL6)
10. Create *Hierarchical Clustering with Euclidean Distance* using R. (BTL6)
11. Examine *K-Medoids* clustering using R. (BTL4)
12. *Detecting and Removing outliers* using R. (BTL1)
13. Construct *Density Based Clustering* using R. (BTL6)
14. Illustrate *Linear Regression* using R. (BTL2)
15. Illustrate *Multiple Regression* using R. (BTL2)
16. Illustrate *Logistic Regression* using R. (BTL2)
17. Construct *Outlier Detection by Clustering* using R. (BTL6)
18. *Detecting and Removing Missing values* in R. (BTL1)
19. Create different kinds of *Charts* using *Sample Data Sets* in R. (BTL6)
20. Create *Word Cloud* using R. (BTL6)

Websites of Interest :

1. <https://www.cs.waikato.ac.nz/ml/weka>.
2. <https://weka.wikispaces.com>
3. <https://www.rdocumentation.org/packages/stats/versions/3.6.2>
4. <http://www.r-bloggers.com/>

Course Focus: Foundation / Employability / Skill Development.